

**Performance Evaluation of Sediment Control Practices**

by

Brian Gerald Roche

A thesis submitted to the Graduate Faculty of  
Auburn University  
in partial fulfillment of the  
requirements for the Degree of  
Master of Science

Auburn, Alabama  
December 9, 2023

Keywords: Sediment Control, Vegetated Buffers, Sediment Barriers

Copyright 2023 by Brian Roche

Approved by

Michael A. Perez, Chair, Associate Professor of Civil and Environmental Engineering

Wesley N. Donald, Research Fellow of Civil and Environmental Engineering

Xing Fang, Professor of Civil and Environmental Engineering

J. Blake Whitman, Assistant Professor of Biosystems Engineering and Soil Science, University  
of Tennessee, Knoxville

## **Abstract**

Sediment is a major pollutant of waterways, increasing turbidity, carrying other harmful pollutants, and reducing flow capacity, which can lead to loss of aquatic life and increased risk of flooding. Construction projects, due to their earth-disturbing nature, are one of the leading causes of sediment runoff. To protect water bodies and natural areas, the United States Environmental Protection Agency requires construction projects with disturbed land within 50 ft (15 m) of a water of the United States to provide and maintain a 50 ft (15 m) vegetated buffer or provide equivalent sediment controls. Despite this requirement, there is little guidance on the effectiveness of vegetated buffers in removing sediment or how sediment barriers can aid shorter buffers or replace buffers. A modeling methodology was developed that evaluated the sediment removal capabilities of 50 ft (15 m) vegetated buffers; 11,664 buffers with conditions local to Nebraska were evaluated and ranged from 18.5% to 99.5% sediment capture with an average of 92.6%. All analyzed properties of the vegetated buffers were found to have an impact on the sediment capture capabilities of the buffers.

To evaluate alternative sediment control practices, a large-scale testing apparatus at the Auburn University – Stormwater Research Facility was used to evaluate Nebraska Department of Transportation standard sediment barrier installations of silt fences, slash mulch berms, and wattles; all standard installations experienced structural inefficiencies that led to them being ineffective at capturing sediment under standard or excessive impoundment conditions. Modified installations, resulting in most feasible and effective installations, were evaluated to improve upon structural inefficiencies of the standard installations. A silt fence installation that employs a 6 in. (15.2 cm) offset trench to prevent undermining, reduced post spacing in areas of increased impoundment to prevent fabric sag, and a dewatering board with overflow weir to allow for

timely dewatering and the creation of an emergency spillway to protect the installation from excessive impoundment was developed through iterative testing of modifications. This most feasible and effective silt fence installation treated stormwater in turbidity through the process of sedimentation within the impoundment formed and captured an average of 85.5% of introduced sediment upstream of the practice. A slash mulch berm installation with a reduced profile to use less material than the standard and compacted in three lifts to facilitate more impoundment was developed; this installation captured an average of 73.5% of introduced sediment upstream of the practice but was also able to capture sediment within the practice, leading to a total average sediment capture of the installation of 98.9%. A straw wattle installation was developed that used sod staples to facilitate ground contact and non-destructive teepee staking at joints with an increased overlap of wattles to ensure consistent impoundment capabilities. The most feasible and effective straw wattle installation allowed for the overtopping of wattles, allowing for maximum impoundment to be reached, rather than flow bypass or undermining; this installation captured an average of 80.8% of sediment upstream and facilitated a maximum impoundment depth of 7 in. (17.8 cm). An excelsior wattle installation using the same method was tested to allow for a comparison of material; the excelsior wattle had higher flow-through rates, which led to less impoundment facilitated, less sediment capture at 75.3%, and discharge that was higher in turbidity and total suspended solids.

These findings indicate that 50 ft (15 m) vegetated buffers can be highly effective in capturing sediment, especially in buffers with shallower slopes experiencing runoff with larger average size soil. Large-scale testing of sediment barrier standard installations indicated a need for modifications to increase the protection of downstream areas. However, even with these

modifications, most sediment barrier installations failed to match the sediment capture capabilities of 50 ft (15 m) vegetated buffers.

## **Acknowledgments**

I would like to thank everyone who has supported me throughout my educational journey. Most importantly, my parents and family who have supported me every step of the way. Dr. Michael Perez, Dr. Wesley Donald, and Dr. Blake Whitman, your guidance and support have been invaluable throughout my graduate studies thus far. Additionally, I would like to thank Dr. Xing Fang for being on my thesis defense committee. I would also like to thank Kris Ansley, Guy Savage, and the group of amazing undergrad research assistants that have assisted over the past two years and whose countless hours of hard work allowed this research to be completed. I would also like to thank the rest of the Auburn Stormwater team for being there to help in both research and as friends. I would also like to thank the rest of my friends, those in the Civil and Environmental Engineering Department and outside of it, who have been by my side during my time in Auburn.

## Table of Contents

1	Introduction.....	11
1.1	Background .....	11
1.2	Erosion and Sediment Control .....	12
1.3	Definition and Purpose of Sediment Barriers .....	13
1.4	Research Objectives .....	14
1.5	Expected Outcomes.....	15
1.6	Organization of Thesis .....	16
2	Determination of Vegetated Buffer Effectiveness.....	18
2.1	Introduction .....	18
2.1.1	Definition and Purpose of Vegetated Buffers in Sediment Control .....	18
2.2	Literature Review.....	19
2.2.1	Vegetated Buffer Regulations.....	19
2.2.2	Vegetated Buffer Experiments.....	21
2.2.3	Vegetated Buffer Modeling .....	28
2.2.4	Soil Loss Modeling.....	29
2.2.5	Literature Review Summary .....	32
2.3	Means and Methods for Determining Sediment Removal Efficiency of Undisturbed Vegetated Buffers on Nebraska Highway Construction Projects.....	33
2.3.1	Soil Risk Analysis of Nebraska .....	33
2.3.2	RUSLE2.....	35
2.3.3	Profile Development .....	37
2.3.4	Factor Selection .....	38
2.3.5	Determining Efficiency.....	42
2.3.6	Summary .....	43
2.4	Results of Modeling of Undisturbed Vegetated Buffers in Sediment Removal .....	43
2.4.1	Effects of Soil Characteristics on Sediment Capture.....	47
2.4.2	Effects of Buffer and Site Slope on Sediment Capture.....	50
2.4.3	Effects of Vegetation on Sediment Capture.....	52
2.4.4	Effects of Climate on Sediment Capture .....	54
2.4.5	Multiple Linear Regression Model .....	56
2.5	Usable Tool for Vegetated Buffer Sediment Removal Analysis .....	58
2.6	Summary .....	59
3	Chapter 3: Large-Scale Performance Evaluation of Sediment Barriers .....	61
3.1	Introduction .....	61
3.2	Sediment Barrier Literature Review .....	61
3.2.1	Common Installed Sediment Barrier Practices.....	62
3.2.2	Silt Fence .....	62

3.2.3	Wattles .....	64
3.2.4	Slash Mulch Berms .....	67
3.2.5	Hay Bales .....	69
3.2.6	Other Sediment Barriers .....	69
3.2.7	Field Monitoring of Sediment Barrier Installations.....	71
3.2.8	Small-Scale Sediment Barrier Testing.....	74
3.2.9	Large-Scale Sediment Barrier Testing.....	79
3.3	Sediment Barrier Testing Methodology.....	85
3.3.1	Runoff Analysis for Nebraska Testing .....	85
3.3.2	Experimental Design.....	89
3.3.3	Materials for Testing.....	93
3.4	Sediment Barrier Testing Results.....	94
3.4.1	Silt Fence Results.....	94
3.4.2	Slash Mulch Berm Results.....	109
3.4.3	Straw Wattle Results.....	118
3.4.4	Excelsior Wattle Results .....	128
3.5	Sediment Barrier Testing Comparison.....	130
3.6	Sediment Barrier Testing Summary.....	135
4	Chapter 4: Conclusions and Recommendations .....	137
4.1	Introduction .....	137
4.2	Sediment Removal Capabilities of Vegetated Buffers.....	138
4.3	Performance Evaluation of Sediment Barriers.....	141
4.4	Implementation and Expected Benefits.....	143
4.5	Recommendations for Future Research .....	144
4.6	Conclusions .....	145
4.7	Acknowledgements .....	146
5	References.....	147
6	Appendix A: Alabama Power Slash Mulch Berm Testing Final Report.....	154
7	Appendix B: Sediment Barrier Testing Logs.....	168
8	Appendix C: Sediment Barrier Specifications .....	263

## **List of Tables**

Table 2.1 Summary of Selected Soils. ....	39
Table 2.2 Summary of Factors .....	42
Table 2.3 Vegetated Buffer Modeling Results. ....	45
Table 2.4 Sediment Loading and Capture by Soil Texture .....	49
Table 2.5 Comparison of Capture of Sandy Soil and All Other Soils.....	50
Table 2.6 Comparison of Sediment Capture and Soil Loss by Location. ....	55
Table 2.7 Summary of Linear Regression Model for Grasses .....	57
Table 2.8 Summary of Linear Regression Model for Row Crops. ....	57
Table 3.1 Water Quality Data across Woven Fabric Silt Fence Installations.....	105
Table 3.2 Statistical Analysis of Impoundment and Discharge Turbidity.....	107
Table 3.3 Water Quality Data across Testing of Backed Silt Fence Fabric. ....	108
Table 3.4 Water Quality Data across Testing of High Porosity Silt Fence Installation .....	108
Table 3.5 Water Quality Data for Slash Mulch Berms.....	116
Table 3.6 Water Quality Data for Straw Wattles. ....	126
Table 3.7 Water Quality Data for Excelsior Wattles .....	130
Table 3.8 Sediment Barrier Testing Summary. ....	136



## List of Figures

Figure 2.1 Nebraska Soil Loss Risk and Mean Annual Rainfall .....	35
Figure 2.2 Profile View of Simulated Construction Site and Vegetated Buffer. ....	37
Figure 2.3 Analyzed Counties, Landscape Regions, and Annual Rainfall Erosivity .....	41
Figure 2.4 Buffer Iteration Distribution.....	47
Figure 2.5 Sediment Capture Distribution of Buffer Iterations by Soil Series. ....	48
Figure 2.6 Average Sediment Capture by Percent Fines.....	49
Figure 2.7 Sediment Capture by Buffer Slope.....	51
Figure 2.8 Average Sediment Capture by Vegetation Type. ....	52
Figure 2.9 Vegetated Buffer Performance Tool. ....	59
Figure 3.1 Nebraska DOT Silt Fence Installation.....	63
Figure 3.2 Nebraska DOT Silt Fence Installation Details .....	64
Figure 3.3 Wattle Installations on Nebraska Highway Construction Project. ....	65
Figure 3.4 Nebraska DOT Tubular Installation Details .....	67
Figure 3.5 Slash Mulch Berm Installation. ....	68
Figure 3.6 Nebraska DOT Slash Mulch Berm Standard Cross-Section. ....	69
Figure 3.7 Iowa Sediment Barrier Field Monitoring .....	73
Figure 3.8 AU-SRF Small-Scale Sediment Barrier testing Apparatus. ....	78
Figure 3.9 Schematic of Testing Apparatus used by Bugg et al. and Whitman et al. ....	83
Figure 3.10 Hydrological Conditions of Nebraska. ....	87
Figure 3.11 Sediment Barrier Testing Regime.....	93
Figure 3.12 Dewatering Board with Overflow Weir.....	96
Figure 3.13 Structural Performance Inefficiencies Experienced by Nebraska DOT Standard Silt Fence Installations. ....	97
Figure 3.14 Reduced Sagging Experienced by Modification 2 .....	99
Figure 3.15 Bypassing of Overflow Weir under Excessive Impoundment Conditions. ....	101
Figure 3.16 Overflow Weir Dewatering. ....	102
Figure 3.17 Scour Downstream of Dewatering Board Installation without Energy Dissipation Device .....	103
Figure 3.18 Performance of High Porosity Silt Fence Installation. ....	104
Figure 3.19 Water Quality Over Time for Woven Silt Fence Installations. ....	106
Figure 3.20 Slash Mulch Berm Installations.....	111
Figure 3.21 Impoundment Formed by Nebraska DOT Slash Mulch Berm Standard.....	112
Figure 3.22 Average Impoundment of Slash Mulch Berm Installations.....	114
Figure 3.23 Average Flow Rate through MFE-I Slash Mulch Berm Installations.....	115
Figure 3.24 Water Quality Performance of MFE-I Slash Mulch Berm Installations. ....	117
Figure 3.25 Straw Wattle Installations .....	120
Figure 3.26 Straw Wattle Standard Installation Undermining.....	121
Figure 3.27 Performance of Straw Wattle Modification 1.....	122
Figure 3.28 Performance of Straw Wattle Modification 2.....	123
Figure 3.29 Average Impoundment Depth for Straw Wattle Installations.....	124
Figure 3.30 Flow Rate through Straw Wattle MFE-I Installations. ....	125
Figure 3.31 Water Quality Data for Straw Wattle MFE-I.....	127

Figure 3.32 Flow through Excelsior Wattle Installations. ....	129
Figure 3.33 Impoundment Facilitated by Sediment Barrier MFE-Is.....	131
Figure 3.34 Flow-through Rates of Sediment Barrier MFEI-Is.....	132
Figure 3.35 Discharge Water Quality of Evaluated Sediment Barriers. ....	133
Figure 3.36 Average Sediment Capture for Standard and Modified Sediment Barrier Installations .....	134

## CHAPTER ONE: INTRODUCTION

### 1.1 Background

Construction activities typically disturb vegetation that had once protected soil from erosive forces. Rainfall on unprotected soil causes erosion due to the energy of raindrops hitting the soil, as well as flow down slopes that form rills and, if not appropriately managed, gullies. This flow, while also causing additional erosion, can carry soil and other pollutants off-site and into protected water bodies. Sediment controls are installed on the perimeter of sites to intercept flow that would leave the site and enter waterways.

The United States Environmental Protection Agency (USEPA) outlines and enforces water quality protection through the Construction General Permit (CGP) which aims to protect natural areas and protected water bodies from pollutant-laden runoff, including sediment, harmful contaminants that can bond to sediment including zinc, lead, and pesticides, and other pollutants such as spilled fuel, paint, or solvents, from areas of construction activities (Mahler 2018; USEPA 2022a). In addition to requiring perimeter sediment controls, the CGP requires every area of earth-disturbing activity that is within 50 ft (15 m) of a Water of the United States (WOTUS) to fulfill one of three options to protect the water body: (1) provide and maintain a 50 ft (15 m) natural vegetated buffer between the site and the water body, (2) provide and maintain a shorter natural vegetated buffer with additional sediment controls that provide the same total sediment reduction capabilities, or (3) provide no buffer and install sediment controls that provide the total sediment reduction of a 50 ft (15 m) vegetated buffer. The USEPA provides tables in Appendix F of the CGP that estimate sediment removal percentages for various 50 ft (15 m) buffers configurations; however, these tables are limited in nature, only existing for the states and territories that do not have permitting capabilities (i.e., Idaho, Massachusetts, New

Hampshire, New Mexico, Washington DC, American Samoa, Northern Mariana Islands, Guam, Puerto Rico, and the Virgin Islands), only considering particular vegetation and soil types, and having a maximum removal of 90% (USEPA 2022a). For all other jurisdictions, the amount of sediment removal by vegetated buffers and other sediment controls is not readily available.

Due to the lack of data on sediment removal of 50 ft (15 m) vegetated buffers, the required protection from secondary sediment controls is not readily available for the erosion and sediment control (ESC) industry. This lack of guidance can lead to pollution due to under-protection or overspending on controls. Additionally, there is a lack of guidance on the protection sediment control provides under design storm conditions. Large-scale sediment barrier testing has been conducted at the Auburn University – Stormwater Research Facility (AU-SRF); however, the conditions sediment barriers were subjected to were local to design storm conditions in the Southeastern U.S., which are drastically different from conditions in the Midwestern U.S.

## **1.2 Erosion and Sediment Control**

ESC practices, often referred to as Best Management Practices (BMPs), are used to prevent erosion from occurring and capture sediment from stormwater before being discharged properly off-site, respectively. ESC practices include erosion control blankets, diversion swales, sediment basins, sediment barriers, and others. Due to on- and off-site impacts of erosion and sedimentation, erosion and sediment-laden discharge have been identified as critical issues facing the construction industry. Construction sites are especially prone to erosion due to the removal of vegetation that once held soil in place and increased compaction that reduces infiltration, resulting in increased runoff volume and velocity, leading to more sediment-laden runoff and increased erosion. Soil loss on construction sites can lead to the loss of nutrients and

organic matter in the topsoil, reducing the fertility of the area for future vegetation. The loss of organic matter also reduces infiltration, leading to more runoff and more pollutants in runoff due to fertilizer and pesticides being unable to be absorbed into the soil. Off-site, sediment-laden runoff entering waterways can cause excess turbidity in the water, preventing sunlight from reaching vegetation at the bottom of the waterway while also carrying excess nutrients and pollutants, causing additional harm to aquatic life. Sedimentation within waterways can also build up, leading to loss of flow capacity and increased flooding; efforts to correct this can have high costs for local governing bodies. (United States Department of Agriculture 2000).

To protect water bodies from this runoff and other pollutants, the US Congress passed regulations in the Clean Water Act of 1972. The Clean Water Act protects waterways by making it unlawful to discharge pollutants into waterways without proper permitting and establishing the National Pollutant Discharge Elimination System (NPDES) permitting process (USEPA 2022b). The NPDES permit is issued by the USEPA to state regulatory agencies that have been granted oversight authority or by the USEPA directly for other jurisdictions to provide coverage on construction sites over one acre in size to protect bordering waterways; this permit requires the development of a Storm Water Pollution Prevention Plan (SWPPP). A site's SWPPP requires the outlining of protection measures of bare soil through stabilization methods such as erosion control blankets, temporary and permanent vegetation and the installation and maintenance of BMPs on the perimeter of the site, including vegetated buffers or other installed sediment barriers (Ducey and Patrick 2021).

### **1.3 Definition and Purpose of Sediment Barriers**

Sediment barriers are temporary sediment control practices installed downstream of a disturbed area intended to remove large-sized suspended sediment from sheet flow runoff by

facilitating settling and to a lesser extent filtration (Barrett et al. 1998a; IECA 2022). Sediment barriers are commonly installed along the perimeter of a construction site. Sediment barriers are especially important on highway construction projects due to their linear nature, which results in a large amount of sheet-flow discharge points along the right-of-way (Burns and Troxel 2015).

A typical highway construction site can have dozens, if not hundreds of individual discharge points. In comparison, other types of construction sites, such as commercial, residential, or industrial construction, may have much fewer (Burns and Troxel 2015). A discharge point is a location within a project where water leaves the project boundary and enters a neighboring area. The discharge point may be referred to as an outfall, particularly if it leaves the site in a channelized conveyance and/or discharges directly into a waterbody (King et al. 2006).

#### **1.4 Research Objectives**

This research was divided into two main components associated with determining the sediment reduction efficiency of 50 ft (15 m) vegetated buffers and large-scale testing of sediment barriers:

- (1) Develop a modeling methodology to evaluate the performance of vegetated buffer configurations typical to Nebraska Department of Transportation (DOT) highway construction projects in the removal of sediment from flow generated from construction activities.
- (2) Conduct large-scale laboratory testing on sediment barrier practices employed by Nebraska DOT under soil losses and runoff volumes associated with Nebraska DOT highway construction projects to supplement buffers that are unable to meet the minimum length requirement of 50 ft (15 m).

To reach these objectives, the research plan was divided into the following four tasks:

- (1) Conduct a comprehensive literature review on sediment removal efficiency of vegetated buffers, past testing and modeling of buffer performance, and past testing of sediment barrier performance under small, large, and field scale testing. Key findings from this task determined factors for analysis of buffers and sediment barriers and were used to develop testing methodologies.
- (2) Develop a methodology and modeling process for evaluating performance of buffer configurations. The process aimed to be repeatable for buffers of various configurations and locations and included factors found to be pertinent to sediment removal from the comprehensive literature review.
- (3) Develop large-scale testing methodology based on conditions local to highway construction projects in the State of Nebraska. Quantities of sediment introduction and flow rates were determined using methods outlined in the literature review. Data collected during testing considered performance factors that were found to be pertinent in reviews of past testing.
- (4) Perform large-scale testing at the Auburn University – Stormwater Research Facility. Standard installations were tested, and modifications were generated to improve upon deficiencies discovered in standard installations through testing and through observations of field installations.

## **1.5 Expected Outcomes**

The expected outcomes of this research study are to provide the state of Nebraska and the ESC industry as a whole with additional guidance on the performance of vegetated buffers in sediment capture and installed sediment barriers in sediment-laden stormwater treatment, as well

as providing a repeatable modeling methodology for the determination of vegetated buffer performance. Large-scale performance testing on Nebraska DOT sediment barrier standards allows for the design of modifications to increase the structural performance of installations through scientifically backed results. The results of modeling of vegetated buffers will be used to generate a usable tool that allows designers and contractors to determine the percent sediment capture in a vegetated buffer with their localized conditions. Detailed guidance will allow for the selection and design of sediment control practices that provide equivalent protection to 50 ft (15 m) vegetated buffers. This research study as a whole will also recommend additional research efforts in sediment barrier and vegetated buffer effectiveness to further increase the base of knowledge on ESC practices used on construction projects.

## **1.6 Organization of Thesis**

This thesis is divided into four chapters that organize, illustrate, and describe steps taken to meet the defined research objectives. Following this chapter, Chapter Two: Determination of Vegetated Buffer Effectiveness, describes vegetated buffers and past research into effectiveness in treatment of sediment and pollutants through vegetated buffers, outlines the development of a modeling methodology to determine the sediment removal efficiency of a 50 ft (15 m) vegetated buffer on the perimeter of a construction site, and presents the results of modeling. Chapter Three: Large-Scale Performance Evaluation of Sediment Barriers, gives background on sediment barriers and past sediment barrier testing efforts, outlines the testing methodology used to determine the effectiveness of Nebraska DOT sediment barriers and developed modifications under conditions local to Nebraska to determine the most feasible and effective and the results of testing. Chapter Four: Conclusions and Recommendations provides usable guidance on the sediment removal capabilities of various vegetated buffer configurations local to highway



construction in the state of Nebraska and provides insight on the performance of tested sediment barriers. Additionally, this chapter identifies areas of potential future research that can be conducted to advance the body of knowledge.

## **Chapter 2: Determination of Vegetated Buffer Effectiveness**

### **2.1 Introduction**

Vegetated buffers are often used as protection for waterways and natural areas from sediment-laden runoff from construction sites; however, the performance in buffers can drastically vary in site-specific conditions such as slope, soil, vegetation, and climate, making it difficult for designers, engineers, and contractors to know the sediment capture capabilities of their site-specific vegetated buffer. This chapter outlines past research on vegetated buffer performance, especially identifying factors that influence vegetated buffer performance; a methodology to determine vegetated buffer performance in sediment capture through modeling; and the results of the modeling completed.

#### **2.1.1 Definition and Purpose of Vegetated Buffers in Sediment Control**

A buffer is an area that provides separation between areas to prevent harm to one or all of the adjacent areas (*Merriam-Webster Dictionary 2023*). A vegetated buffer may be found along waterbodies or other natural areas to provide separation from pollutants created by human activities. They are commonly used along croplands, construction sites, mining, and industrial activities. A vegetated buffer is made up of an area, strip, or plot and typically contains dense, undisturbed vegetation. The primary purpose is to protect water quality and maintain a healthy aquatic ecosystem in the receiving surface waters. When used along construction sites, land-disturbing activities are prohibited, limited, or restricted within the buffer (IECA 2022). Buffers can treat sheet flow exiting construction sites by allowing stormwater to flow through vegetation. Vegetation provides several benefits, including reducing runoff velocity, promoting infiltration, increasing evapotranspiration, and facilitating filtration. Decreasing velocity not only promotes sediment deposition but also protects downstream areas from soil erosion. Undisturbed vegetated

buffers require minimal installation measures and can be highly cost-effective in protecting adjacent areas. However, due to their space requirements, buffers may be infeasible to maintain on many sites due to lack of space, lack of available right-of-way, or high property costs (USEPA 2021).

## **2.2 Literature Review**

A review of past vegetated buffer research and regulations was conducted to determine the performance of vegetated buffers in capturing sediment from runoff. Relevant factors for analysis were investigated to aid in developing a modeling methodology that determines the performance of 50 ft (15 m) vegetated buffers.

### **2.2.1 Vegetated Buffer Regulations**

The USEPA's NPDES CGP regulates construction activities that have the potential to produce stormwater-related pollutants. The USEPA CGP applies to all states, territories, districts, and tribal lands. The USEPA CGP is used by Idaho, Massachusetts, New Hampshire, New Mexico, Washington DC, American Samoa, Northern Mariana Islands, Guam, Puerto Rico, and the Virgin Islands. Appendix F of the CGP requires one of three methods for the protection of WOTUS located within 50 ft (15 m) of construction sites: (1) maintain a 50 ft (15 m) vegetated and undisturbed buffer; (2) provide a shorter length buffer with a secondary sediment barrier that together provides the total equivalent capture of a 50 ft (15 m) vegetated buffer; or (3) provide a sediment barrier with the equivalent protection to a 50 ft (15 m) vegetated buffer. Appendix F also provides a series of site-specific tables to estimate the sediment removal efficiency of 50 ft (15 m) vegetated buffers. Vegetated buffer sediment removal tables have been developed only for the eight states and territories covered by the USEPA CGP. These tables are simplistic, limited to five soil types and a few (often three to five) vegetated types. Furthermore,

the tables are limited to sites with less than 9% slopes (USEPA 2022a). There is little guidance on how these tables were originally developed.

The 46 states that maintain their own CGPs frequently have similar requirements to those given by the USEPA, but there is some variation. For example, the Nebraska Department of Environment and Energy (NDEE) NPDES Permit for Stormwater Discharge from Construction Sites outlines identical buffer requirements in Part III to those found in Part 2.2.1 of the USEPA CGP (Ducey and Patrick 2021). Section 9.17 of the Minnesota Pollution Control Agency's General Permit to Discharge Stormwater requires sites to provide a 50 ft (15 m) natural buffer or, if infeasible, requires redundant sediment barriers when a site is within 50 ft (15 m) of surface water to protect the waterway (Minnesota Pollution Control Agency 2018). Other states have similar requirements with other required widths; for example, the Alabama Department of Environmental Management requires a 25 ft (7.6 m) riparian buffer or sediment controls that achieve the sediment load reduction of that buffer (Alabama Department of Environmental Management 2021).

Some regulatory bodies base their vegetated buffer requirements on local conditions. For example, the North Carolina Department of Environmental Quality (NCDEQ) delineates buffer requirements by the slope of the buffer. An undisturbed buffer with a slope shallower than 1% is required to have a width of 15 ft (4.6 m); buffers with slopes between 1% and 3% are required to have a width of 20 ft (6.1 m); and buffers with slopes steeper than 5% are required to have a width of 25 ft (7.6 m) plus an additional foot (0.3 m) in width for every percentage of the slope above 5%. Additionally, the minimum width required for an undisturbed vegetated buffer adjacent to trout waters is 25 ft (7.6 m) unless wider is stipulated by other requirements (State of North Carolina Department of Environmental Quality Division of Energy 2019).

The USDA Natural Resource Conservation Service (NRCS) developed and maintains standards for filter strips. Filter strips are similar to vegetated buffers but are often used in agricultural pollution prevention to reduce suspended solids and other pollutants before flow reaches surface waters. These standards include that vegetation must be permanent, herbaceous, stiff-stemmed vegetation that can withstand burial from sediment deposition and is adequately dense to stabilize the area. The NRCS stipulates a minimum flow length of 20 ft (6.1 m) when targeting suspended solids and 30 ft (9.1 m) for treating dissolved contaminants. Additionally, the filter strip is required to remain undisturbed and cannot be used for the transportation of equipment. The slope of filter strips is not to exceed half of the slope of the area upstream of the filter strip or a maximum of 5% (Department of Agriculture Natural Resources Conservation Service 2016). The NRCS provided guidance on the ratio between contributing drainage areas and filter strips based on annual rainfall energy, with larger buffer-to-area ratios required for regions with higher annual rainfall energy (Liu et al. 2008).

Existing vegetated buffer and filter strip regulatory requirements offer insight into past research on their effectiveness. For example, guidance used by the USEPA is a result of a review of numerous vegetated buffer experiments that found that buffers between 33 ft (10 m) and 50 ft (15 m) removed a high percentage of sediment particles, with additional width required to remove other pollutants (USEPA 2012).

### **2.2.2 Vegetated Buffer Experiments**

Determination of suspended sediment and pollutant removal through vegetated buffers has been evaluated through numerous methodologies. Studies investigated various configurations to determine removal efficiency based on different factors, such as width, slope, flow rates, vegetation, and soil types.

Testing of vegetated buffers is typically conducted by introducing sediment or pollutant-laden flow at the top of a sloped test bed consisting of a length of vegetation. A variety of studies investigated buffers of differing length, sediment and flow introduction conditions, vegetation type and density (Arora et al. 2003; Liu et al. 2008; Ramesh et al. 2021; Storey et al. 2009; Yuan et al. 2009; Zhang et al. 2010). There were two primary methods of introducing flow and pollutants: naturally occurring storm events or simulated runoff. Studies using naturally occurring storm events conveyed the runoff from a specific source area with a specific treatment into buffers. Studies introducing simulated stormwater runoff pumped predetermined amounts of steady-state flow and pollutants into buffers (Arora et al. 2003). Sediment or pollutant removal efficiency was typically determined by comparing samples collected from the buffer discharge point to inflow concentrations.

Direct comparison of completed studies can be difficult due to the number of variables involved in testing and various research objectives. Arora et al. used simulated runoff to determine the pollutant and sediment removal efficiency and the infiltration of six identical vegetated buffer strips with 15:1 and 30:1 source-to-area ratios. Flow mixed with soil and pesticides was introduced; infiltration within the buffer strips was calculated by comparing the introduction flow rate to the outflow rate. Testing found that 90.1% of sediment was captured on average with a 38.8% infiltration rate in the 15:1 ratio plots; 86.8% of sediment was captured with a 30.4% infiltration rate in the 30:1 area ratio plots (Arora et al. 2003). Abu-Zreig et al. compared the performance of 20 vegetated filter strip configurations (three lengths, three vegetation types at different coverages, two slopes, and three bare plots as controls) under simulated runoff to determine the effect of different buffer factors on sediment capture. The bare control plots showed the lowest sediment trapping efficiency and water retention at 25% and

22%, respectively. A strong logarithmic relationship was found between vegetation cover and sediment capture, with increased capture as cover increased. In a comparison of vegetation species, introduced perennial rye and a mix of red fescue and birdsfoot trefoil performed similarly (85% and 83%, respectively), while the existing vegetation (a mix of wild oat, quack, fescue, dandelions that was already in place) captured more sediment, with 89%. Analysis of flow rates indicated that trapping efficiency decreased non-linearly as the flow rate increased. An inflow rate of 0.08 gal/s (0.3 L/s) resulted in 90% sediment capture on average; 0.17 and 0.26 gal/s (0.65 and 1.0 L/s) flow rates both resulted in 82% sediment capture on average. The flow length through the buffer was found to be the strongest factor in buffer performance. However, little difference in performance was seen between buffers of 33 and 50 ft (10 and 15 m). (Abu-Zreig et al. 2004)

Field studies can be used to determine the effectiveness of vegetated buffers in removing pollutants such as sediment, especially in post-construction settings. Barrett et al. monitored two grassy swales serving as highway medians in Austin, Texas, for water quality indicators (i.e., TSS, turbidity, pathogens, nutrients, heavy metals, and other pollutants) during rainfall events to determine the treatment of stormwater runoff as flow passed through the vegetation. Each median had a different mix of local grasses, one being primarily prairie buffalo grass and the other being a mix of Bermudagrass, Illinois bundle flower, and other local grasses. Water quality samples were taken from the roadway and the swale to be compared for determining treatment through 34 storm events. Samples were taken along the length of the grassy median during five rainfall events to determine if treatment was occurring along the side slopes or down the length of the median. Both sites showed a substantial reduction in TSS (87% and 85%) and turbidity (69% and 78%); reductions were also shown for nutrients and heavy metals. Due to the native

soil being relatively impermeable compared to other soils, it was found that treatment did not occur due to infiltration within the buffer. Monitoring determined that vegetation can be used in slopes and channels to treat stormwater runoff for pollutants at a similar rate to structural stormwater treatment BMPs (Barrett et al. 1998). Another set of field monitoring conducted by Barrett et al. included eight different vegetated buffers in California that varied widely in conditions. Buffers were monitored for pollutant removal along the width of the buffer during stormwater runoff events. Slopes were between 5% and 52%. Vegetation coverage varied, with one site having as low as 1% coverage at times during monitoring due to being in an arid area. The distance at which pollutant removal stabilized was found for each buffer. For buffers with over 80% vegetation coverage, concentrations of pollutants decreased until 14 ft (4.2 m) for buffers with slopes shallower than 10%. Steeper buffers (between 35% and 50%) were found to require 30 ft (9.2 m) to decrease pollutants. The arid location showed no reduction in pollutant concentrations due to a lack of vegetation coverage. The slope and vegetation cover were both found to have a role in reducing sediment and other pollutants from flow. The buffers with the steepest slopes and the lowest vegetation coverage had a longer distance along the width of the buffer at which TSS concentrations stabilized, indicating two performance factors of buffers. However, buffers at slopes steeper than previously recommended for use still showed substantial pollutant treatment. This monitoring study showed that buffers with up to a 30% slope showed substantial pollutant removal and that buffers with under 80% vegetation coverage exhibited a decline in capabilities to treat stormwater runoff (Barrett et al. 2004; Barrett 2004).

Liu et al. investigated over 80 sediment trapping experiments on vegetated buffers to determine factors influencing vegetated buffer performance. The experiments investigated had varying widths, area ratios, slopes, flow rates, and sediment load reduction. For width, buffers



that did not have adequate width provided inadequate protection; however, there is no optimal buffer size to fully maximize sediment capture without using excessive space due to the considerable variation in factors that can influence capture. A statistical analysis of buffer width in reviewed experiments found that when a buffer is 33 ft (10 m) in width, it is near its maximum sediment reduction capabilities with limited increasing effectiveness as buffer width increases beyond that width. The ratio between the source and buffer areas was also investigated in many studies in the review. The highest sediment trapping efficiency in buffers was in cases where the buffer or filter strip was larger than the source areas. Flow types in experiments primarily operated under the assumption that the flow would be laminar sheet flow in nature; however, this is not always the case in on-site conditions. Sheet flow provides the best performance in vegetated buffers, and buffers were found to not perform adequately under concentrated flow conditions. The slope was found to be another key factor, with removal rates operating best with shallow, uniform flow that occurs most commonly on buffers with shallower slopes. Analysis of slopes on sediment indicated trapping efficiency increased as the slope increased, until reaching 9.2%, at which increasing the steepness of the slope decreased sediment trapping efficiency. The increased slope below 9.2%, leading to increased sediment trapping was due to runoff paths forming to allow sediment to be trapped in vegetation. Past 9.2%, the flow velocity increases as the slope gets steeper to the extent where sediment capture decreases. The relationship defined between sediment capture and the slope was a second-order polynomial with an  $R^2$  of 0.23. Higher rainfall intensity led to decreased performance. In addition to facilitating higher sediment loads, higher rainfall saturates the soil of buffers and can limit the infiltration of smaller sediment particles into the native soil. A statistical analysis of a collection of factors (width, slope, area ratio, width<sup>2</sup>, slope<sup>2</sup>, and area ratio<sup>2</sup>) was completed to determine which factors were the most

pertinent in sediment capture efficiency. A satisfactory fit model ( $R^2$  of 0.43) generated found that width and slope were the most pertinent. The model suggested that a slope of around 9% maximizes capture, matching the results from the analysis of slope alone. Despite using the results of over 80 experiments, this study did not investigate the differences in efficiencies between different vegetation types and densities (Liu et al. 2008).

Ramesh et al. investigated the factors affecting sediment removal by a vegetated buffer, finding similar results to the Liu et al. study while also investigating additional factors such as sediment loads, roughness, and vegetation characteristics. The 342 experiments over 52 studies found a mean removal of 75%, a median removal of 82%, and ranged from 0% to 100%. Investigation of vegetation found that the type of vegetation (i.e., grass, woody, and grass-woody mixes) was statistically significant, with woody vegetation-only buffers performing worse. However, there was not a complete mix of vegetation and other factors in the experiments analyzed. Only six experiments had wood vegetation, all of which had the same slope of 5% and a width of 30 ft (9.1 m). Due to this lack of variety, the authors suggest that more analysis and experiments are required to determine the effectiveness of woody vegetation on buffer performance. To determine a relationship between buffer width and sediment removal, the average removal at each buffer width was plotted; a similar logarithmic pattern reduced additional removal after 33 ft (10 m) was shown in this analysis from the analysis completed by Liu et al. The findings of this study conclude that many factors play a role in sediment removal efficiency and that the large variation in buffers indicates a need for buffers in different regions to be designed differently (Ramesh et al. 2021).

Through testing and field monitoring, rainfall has been found to have a role in the sediment removal capabilities of vegetated buffers. Areas that experience high rainfall will have higher

erosion and flow rates passing through buffers, leading to an increased load of sediment-laden stormwater runoff that passes through a buffer. Additionally, higher moisture content within the soil can reduce the infiltration rates due to the soil becoming saturated; infiltration is the primary method by which finer soil particles are removed from flow in a vegetated buffer (Ramesh et al. 2021). Areas with little rainfall, such as those experiencing drought conditions, can have higher infiltration rates; however, droughts adversely affect vegetation growth and overall coverage, reducing sediment capture efficiency (Cerda et al. 1998; Liu et al. 2008).

Small-scale flume testing can be used to determine the sediment deposition and hydrological effects of flow passing through vegetation. Ghadiri et al. compared the flow through a bed of nails and a grass bed with both soil introduced and clean water at different flume slopes. Grass strips blocked and reduced flow velocity, forming an impoundment or backwater behind the area of grass. The length and depth of impoundment decreased as the slope of the flume increased. Once the slope of the flume reached 5.2%, grass strips began to be overrun by the flow and pushed down, causing less impoundment to be formed. During experiments where the flume was lined with soil, sediment deposition occurred in the impoundment formed behind the grass, with a growing impoundment as sediment was deposited. As the slope of the flume increased, less deposition occurred. The role of grass in slowing flow down and allowing for sediment deposition matches the mechanisms noted during large-scale testing of vegetated buffers (Ghadiri et al. 2001).

Testing of vegetated buffers has indicated that there are critical factors in determining the performance of a buffer in removing sediment and other pollutants. The slowing of flow and facilitation of sedimentation are affected by most of these factors, with others influencing infiltration rates. Slope and width are two of the most important, with decreases in slope and

increases in width facilitating more sediment capture on average (Liu et al. 2008). Both width and vegetation density were shown to have logarithmic relationships with sediment capture, leading to limited additional benefits once substantial removal is facilitated by the width and vegetation density (Abu-Zreig et al. 2004; Liu et al. 2008).

### **2.2.3 Vegetated Buffer Modeling**

Efforts have been made to model sediment transport and deposition as sediment-laden flow moves through a vegetated buffer. Zhang and Zhang aimed to create a statistical model using measured rainfall, stream flow, and pollutant conditions to determine the sediment and pollutant treatment of agricultural runoff of various BMPs within a watershed in California. The analysis included buffers using a relationship between width and capture that resulted in additional capture with increased width but lesser benefit past a certain point. The modeling results showed that an 82 ft (25 m) buffer could remove 56% of sediment and 89% of pesticides, showing a need for additional BMPs to support additional removal. The authors also suggest that future models need to be developed that consider more variables, such as slope, vegetation, and pollutant properties, to improve results (Zhang and Zhang 2011).

Munoz-Carpena et al. created three sub-models to determine the performance of vegetated filter strips in removing sediment from sheet flow. Each sub-model represented a mechanism that occurs as the flow enters and passes through a vegetated filter strip. The two main mechanisms were sediment transport by flow and deposition within the vegetation. The third sub-model represented infiltration within the vegetated filter strip. Parameters included in the hydrology sub-model included vegetated filter strip characteristics: slope, length, width, Manning's roughness, and water content. The analysis of sediment transport and deposition included particle size distribution, vegetation media characteristics, and inflow concentrations, with the main

factors being media spacing and particle size. The produced model was verified by testing the sediment removal of six filter strips of a grass mix and various slopes by comparing the upstream and downstream water quality during 27 naturally occurring rain events. Testing resulted in a good fit to the model, with variations being due to the facilitation of channelized flow through the filter strip instead of sheet flow, which has been shown to reduce the effectiveness of vegetated buffers and filter strips (Muñoz-Carpena et al. 1999).

#### **2.2.4 Soil Loss Modeling**

To predict the annual rate of soil erosion an area experiences based on certain site-specific factors, the Universal Soil Loss Equation (USLE) was developed in 1965 by the USDA National Runoff and Soil Loss Data Center.

$$A = R \times K \times L \times S \times C \times P \quad \text{Eq. (2.1)}$$

Where:

A = Average annual soil loss (tons/ac/yr)

R = rainfall and runoff factor

K = soil erodibility factor

L = slope-length factor

S = slope-steepness factor

C = cover and management factor

P = support practice factor

The equation, shown in Eq. 2.1, is based on extensive research conducted around the United States and considers six factors: rainfall and runoff, soil erodibility, slope length, slope steepness, cover and management, and any support practices in place. A major improvement of USLE over existing soil loss modeling equations is its applicability to the entire United States, while previous models were tied to specific regions (United States Department of Agriculture

2016). The rainfall factor, or R-factor, was calculated by determining the rainfall energy and intensity of specific storm events in different areas of the United States; typically, values are read off an isoerodent map. The soil erodibility factor, or K-factor, was developed by determining the rate of soil loss for a unit plot, 72.6 ft (22.1 m) with a 9% slope, over a known period for various soils. From this data, a soil erodibility nomograph was developed to aid designers and users in determining the K-factor for their soil using characteristics of the on-site soil. The topographic factor, or LS factor, based on slope-length and slope-steepness factors, is the ratio between the soil loss on the unit plot and the site slope in question. A table was developed from an equation that users can interpolate values from based on their site conditions. The LS factor can be as low as 0.060 for a 25 ft (7.6 m) long slope with a 0.2% slope but can be over 10.0 for longer, steeper slopes, such as those in excess of 18% and 1,000 ft (305 m) in length. The cover and management factor, or C factor, is the ratio of soil loss on a bare slope to a slope with a specific cover; it was developed from soil loss and runoff measurements due to natural rain of over 10,000 plot-years with various types of cover in place. The support practice factor, or P factor, considers support practices that prevent soil erosion and runoff, such as contouring, strip-cropping, and terracing (Wischmeier and Smith 1978).

To improve upon the USLE, the Revised Universal Soil Loss Equation (RUSLE) was developed by the USDA; key changes were that each factor used in USLE was changed to improve accuracy while keeping the same framework of the USLE. The rainfall factor was improved by adding data for more locations to increase the accuracy of the isoerodent map, especially in the western United States. The K factor was changed to vary seasonally instead of being a constant throughout the year. The different susceptibility to rill erosions for different soils was also expanded upon. The slope-length and slope-steepness factors were changed to

allow for the analysis of slopes of varying shapes. The cover factor was adjusted to be composed of four sub-factors (e.g., prior land use, canopy, surface cover, and surface runoff) that all affect the amount of soil loss on a slope. The practice factor was previously unreliable due to a lack of analysis of sub-characteristics of terracing and contouring that affect flow paths and did not consider rangeland conservation practices or slope-dependent practices. The changes between RUSLE and USLE result in differences in total estimated soil loss for two identical areas between the two equations; this difference can be either more or less estimated soil loss, depending on how the region was affected by changes (Foster et al. 2003).

To further improve soil loss modeling, the USDA developed the Revised Universal Soil Loss Equation 2 program (RUSLE2). RUSLE2 uses the same factors as the USLE but improves upon it by integrating all factors on a daily basis to calculate net detachment per day instead of annual approximates. Additionally, the program has a user-friendly interface that allows for selecting site-specific conditions. Soil data can be pulled from the Web Soil Survey to facilitate the selection of the exact native soil type of a site. The cover factor in RUSLE2 is variable to time and includes analysis of ground cover, percent canopy cover, fall height, community types, and live vegetation contact with soil, which is an improvement from RUSLE (Foster et al. 2003; Renard et al. 1997; USDA 2016). RUSLE2 can calculate soil loss and sediment delivery rates across multiple slopes with differing conditions (e.g., soil type, cover, slope, and length), while past soil loss models could only be used across a single slope at a time. A site's profile can be divided into different segments that have results displayed separately. Additionally, RUSLE2 computes deposition rates, which past equations could not consider. The equation used by the program is shown in Eq. 2.2 (USDA 2016). The fall velocity of the sediment is calculated from its size. The runoff rate is determined from the site's slope, the rainfall experienced, and any

velocity reduction controls in place. Transport capacity is the maximum amount of sediment runoff can carry and is a function of the hydraulic shear stress and a transport coefficient; the capacity increases as the slope of the area increases (Xiao et al. 2017).

$$D = \left(\frac{V_f}{q}\right) (T_c - g) \quad \text{Eq. (2.2)}$$

Where,

$D$  = deposition rate (tons/ft<sup>2</sup> [tonnes/m<sup>2</sup>])

$V_f$  = fall velocity of sediment (ft/s [m/s])

$q$  = runoff rate (ft<sup>2</sup>/s [m<sup>2</sup>/s])

$T_c$  = transport capacity of the runoff (tons/ft [tonnes/m])

$g$  = sediment load (tons/ft [tonnes/m])

The Modified Universal Soil Loss Equation (MUSLE) was developed using similar factors as the USLE and calculates the amount of soil loss from a specific storm event for an area instead of the average total soil loss over the entire year. Peak flow and total volume from a storm event, such as the local 2-yr, 24-hr storm, is used to determine soil loss rather than a rainfall erosivity factor. Calculating for each storm event also takes into account the energy of the runoff causing the soil loss instead of just detachment as the USLE does (Williams and Berndt 1977).

### **2.2.5 Literature Review Summary**

The comprehensive literature review completed on past testing and modeling of sediment and pollutant removal by vegetative buffers or filter strips found key factors relevant in performance: buffer width, buffer slope, soil size distribution, vegetation density, and amount of rainfall experienced. To properly analyze the sediment removal efficiency of undisturbed



vegetated buffers, a wide range of each of these factors that exist within Nebraska highway construction must be taken into account.

### **2.3 Means and Methods for Determining Sediment Removal Efficiency of Undisturbed Vegetated Buffers on Nebraska Highway Construction Projects**

To determine the sediment removal efficiency of 50 ft (15 m) undisturbed vegetated buffers, a repeatable modeling methodology had to be developed that considers common local factors, including selecting a modeling software, developing a standardized site profile, and selecting local conditions. Nebraska, the study area for this modeling effort, was analyzed to determine local conditions found on buffers on Nebraska highway construction projects that would affect the sediment capture capabilities of vegetated buffers. However, the methodology designed is repeatable for other areas of the United States by keeping the same site profile and adjusting local conditions using the site-specific condition selection process outlined for another area.

#### **2.3.1 Soil Risk Analysis of Nebraska**

Before the analysis of vegetated buffers on highway construction in Nebraska could be completed, an analysis of the study area had to be completed. Nebraska is a diverse area in both geology and climate. To assist design and planning across these vast variations of the states, which can affect roadside conditions, especially vegetation, the Nebraska Department of Transportation has outlined six distinct landscape regions: the Loess Hills, Loess & Glacial Drift, Central Loess Plains & Rainwater Basins, Sandhills, Shale Plains – Tablelands, and the High Plains. These regions vary widely in soil composition and climate and were outlined to allow for the roadside vegetation plans to fit the diverse natural landscape across the state of Nebraska. Outlining different acceptable vegetation for different roadside areas allows for the facilitation of

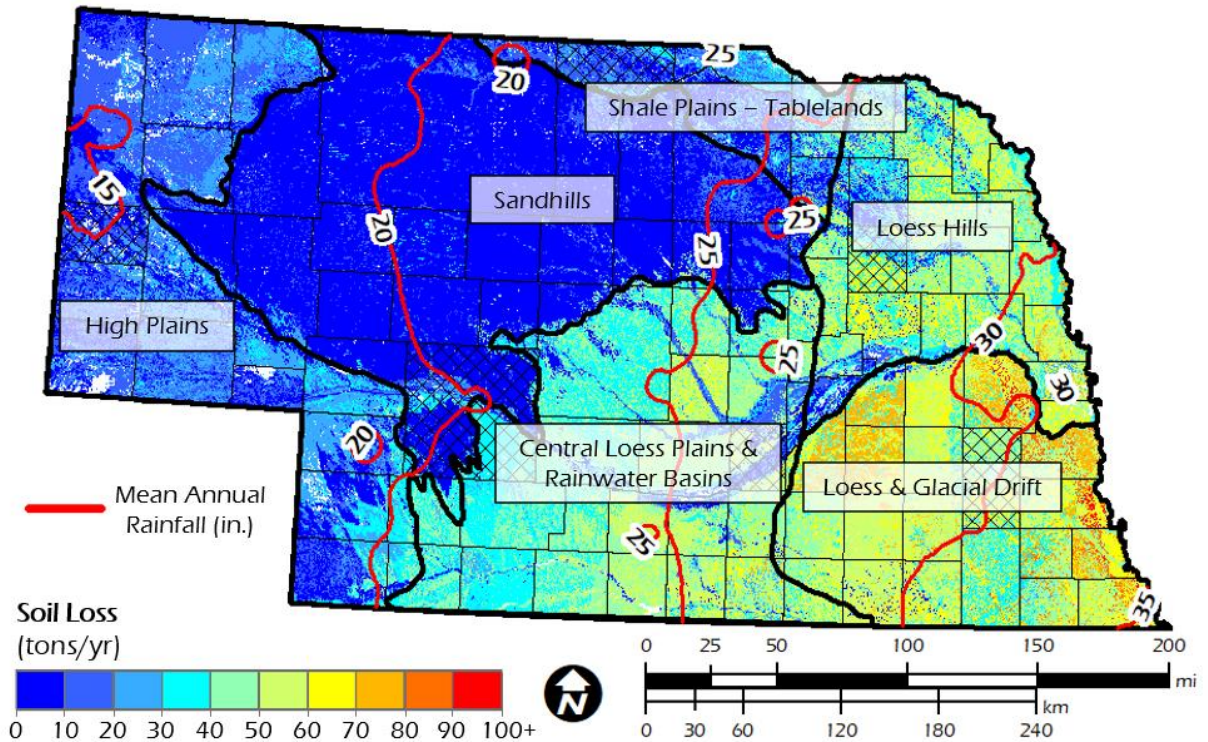
native vegetation growth, leading to the protection of natural areas bordering roadways and roadway construction while also not disrupting the local environment by introducing non-native vegetation (Thompson et al. 2008).

Soil types through the six landscape regions vary, with the Sandhills being composed of primarily sandy soils and the rest of the state being largely silt loams or clay silt loams (USDA 2022). In general, sandy soils are less easily mobilized than clayey and silty soils, leading to less risk of soil loss.

Rainfall also varies through these regions. The annual rainfall in the southeasternmost landscape region, the Loess and Glacial drift, has an annual rainfall of 36.4 in. (925 mm); this is nearly double the average annual rainfall of 17.5 in. (445 mm) in the High Plains, in the most northwestern portions of the state (USA Mean Rainfall 2022).

Due to this considerable variation in both rainfall and soil erodibility, there is a considerable variation in soil loss risk across Nebraska. For example, rainfall erosivity factors range from 31 to 182 hundreds of ft tons  $\text{ac}^{-1} \text{yr}^{-1} \text{in hr}^{-1}$  (528 to 3098 MJ  $\text{mm ha}^{-1} \text{yr}^{-1} \text{hr}^{-1}$ ). To further analyze the variation of soil loss risk across the state of Nebraska, a National Geographic Information System (GIS) map of soil erosion risk was generated using data obtained by Kazaz et al. (2022). For analysis of soil loss risk, only soil and rainfall erosivity factors were used: a length-slope factor of 1.0, representative of a 73 ft (22.2 m) long slope at a 9% slope, and cover and practice factors of 1.0, representative of a bare soil slope with no ESC practices in place, all over a one-acre area (0.4 ha). Figure 2.1 shows the results of a soil loss risk analysis of the state of Nebraska which indicates considerable variation by region of soil loss risk. The Loess & Glacial Drift region has the greatest risk of erosion at 55.2 tons/yr (50.1 tonnes/yr) due to the

region being primarily composed of the more highly erodible soils and experiencing the greatest annual rainfall totals.



**Figure 2.1 Nebraska Soil Loss Risk and Mean Annual Rainfall**

*Note: 1 in. = 2.54 cm*

### 2.3.2 RUSLE2

The USDA-developed program RUSLE2 was selected as the modeling program for this analysis due to its wide range of available data and the ability to calculate soil loss and deposition across multiple slopes while using factors in daily calculations throughout an entire year for an annual calculation. RUSLE2 improves upon predecessors to the program, such as the original Revised Universal Soil Loss Equation and the RUSLE1 program, by calculating all erosive factors (Cover, practice, rainfall, soil, and length-slope) on a daily basis instead of annually. Another critical improvement that RUSLE2 brings is the complexity of the cover factor, which varies throughout the year and includes factors such as surface roughness, canopy

cover, height, community types, amount of live vegetation, and ground cover (Foster et al. 2003; Renard et al. 1997; USDA 2016).

The most relevant improvement to determining the efficiency of vegetated buffers in sediment removal that RUSLE2 contains is the ability to calculate sediment deposition in addition to soil loss. Eq. 2.2 shows the deposition rate calculation based on existing factors used in RUSLE2 (USDA 2016). The runoff rate is based on local conditions, such as the rainfall rate, slope, and velocity reduction measures in place. Fall velocity is a function of the size of the sediment; Stoke's law, as shown in Eq. 2.3, defines that a round particle's fall velocity through a fluid increases when mass and density increase (Weiss et al. 2013).

$$V = \frac{d^2 g (\rho_p - \rho_f)}{18\eta} \quad \text{Eq. (2.3)}$$

where,

$V$  = Settling Velocity (ft/s [m/s])

$d$  = diameter of particle, assumed to be spherical (ft [m])

$g$  = acceleration due to gravity (ft/s<sup>2</sup> [m/s<sup>2</sup>])

$\rho_p$  = mass density of particles (lb/ft<sup>3</sup> [kg/m<sup>3</sup>])

$\rho_f$  = mass density of fluid (lb/ft<sup>3</sup> [kg/m<sup>3</sup>])

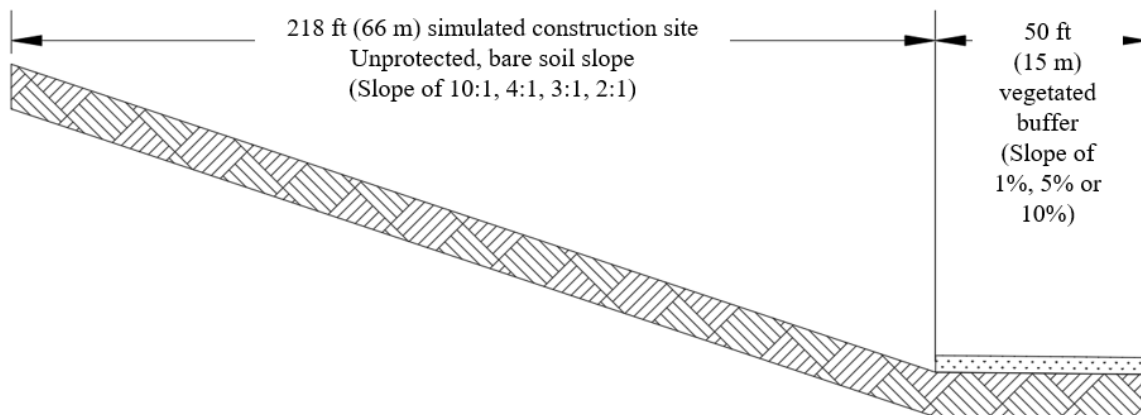
$\eta$  = viscosity of fluid (lb/ft<sup>3</sup> [kg/m<sup>3</sup>])

Based on this, sediment particles with larger diameters can fall out of suspension faster than smaller sediment. Transport capacity, also based on local conditions, is the amount of sediment runoff can carry and increases as the slope increases. This capacity is also a function of hydraulic shear stress and a transport coefficient (Xiao et al. 2017). The deposition rate is given in Eq. 2.2. Based on this equation, key factors relating to deposition are slope, rainfall experienced, upstream erosion experienced, and size of sediment particles, with the deposition

rate increasing as sediment size increases and flow velocity decreases. The method RUSLE2 uses to calculate deposition reiterates the crucial factors needed to be analyzed to accurately determine the sediment removal capabilities of Nebraska Highway construction undisturbed vegetated buffers, with different slopes, rainfall, and soil sizes needing to be used in the analysis.

### 2.3.3 Profile Development

A profile consisting of two slopes was generated in RUSLE2: a bare construction site with no ESC practices in place and a 50 ft (15 m) undisturbed vegetated buffer. The profiles were able to be manipulated independently of each other. The length of the uncovered, bare soil construction site was kept constant through all analyses at 218 ft (66 m), which was used due to it being the length of the representative drainage area used in sediment barrier testing at the Auburn University – Stormwater Research Facility. This length is derived from the guideline used in many states of a maximum drainage area for silt fences of 0.5 ac (0.2 ha) per 100 linear ft (31 m), an area of 0.5 ac (0.2 ha) with a width of 100 ft (31 m) has a length of 218 ft (66 m) (Bugg et al. 2017a). Figure 2.2 shows a profile view of the simulated construction site and vegetated buffer used in modeling.



**Figure 2.2 Profile View of Simulated Construction Site and Vegetated Buffer**

### **2.3.4 Factor Selection**

Factors common to Nebraska highway construction conditions were chosen for analysis, including soils, vegetation species, slopes, and rainfall conditions.

#### **2.3.4.1 Soils**

The USDA Web Soil Survey for Nebraska was used to find the most prevalent soils for analysis. The goal was to select soils that compose a large area of the state, represent all six landscape areas, and are diverse in soil class. Nine soil series were selected that were representative of 34.8% of the area of the state and were sands, silt loams, and silty clay loams. A summary of selected soils is shown in Table 2.1. Data on the size composition is included due to being an essential factor in the ability for sediment to be deposited. Percent passing the #200 sieve, or under 0.002 in. (0.05 mm) in diameter, ranged from under 5% for sandy soils to 93% for Silty Clay Loams and Silt Loams.

**Table 2.1 Summary of Selected Soils**

<b>Soil Series</b>	<b>Statewide Coverage (%)</b>	<b>Landscape Region(s)</b>	<b>Sand<sup>[A]</sup> (%)</b>	<b>Silt<sup>[B]</sup> (%)</b>	<b>Clay<sup>[C]</sup> (%)</b>
Valentine Fine Sand	20.0	Shale Plains, Sandhills	96	0.7	3
Holdrege Silt Loam	2.9	Central Loess Plains & Rainwater Basins	9.4	67	24
Hastings Silt Loam	2.6	Loess & Glacial Drift	13	63	24
Uly-Coly Silt Loam	2.1	Central Loess Plains & Rainwater Basins	21	58	21
Moody Silty Clay Loam	1.7	Loess Hills	6.9	62	31
Valent Sand	1.5	High Plains	95	0.6	4
Coly Silt Loam	1.4	Central Loess Plains & Rainwater Basins	8	71	21
Crete Silt Loam	1.4	Loess and Glacial Plains	7	69	21
Wymore Silty Clay Loam	1.2	Loess and Glacial Plains	17	48	35

*Notes:*

[A] 0.002-0.08 in. (0.05-2 mm)

[B]  $8 \times 10^{-4}$  - 0.002 in. (0.002-0.05 mm)

[C]  $< 8 \times 10^{-4}$  in. (<0.002 mm)

#### **2.3.4.2 Vegetation**

Grass and grass-like vegetation were selected for analysis by determining which species native to Nebraska had data available within RUSLE2 databases (Dunn et al. 2016). Four long-term vegetation types (Dense Grass, Continuous Mixed Grasses, Continuous Gramma, and Range grass four years after last disturbance) and nine species or mixes of species (Big Bluestem, Kentucky Bluegrass and Clover, Orchard grass and Legume, Red Clover, Reed Canary Grass, Switchgrass, Tall Fescue, and Timothy) were chosen for analysis.

Additionally, row crops were selected for analysis by determining which crop species make up most agricultural production in Nebraska. Corn, soybeans, alfalfa, and winter wheat are all produced in Nebraska and were planted on over 900,000 acres of land in 2021. Due to the average yield per acre of corn in 2021 being 194 bu/ac (479.4 bu/ha), corn was chosen to be analyzed at two yield densities that are in the RUSLE2 databases (150 bu/ac (370.7 bu/a) and

224 bu/ac (553.5 bu/ha)), to attempt to analyze the effect of crop density on sediment capture (United States Department of Agriculture 2022). There were two methods of planting soybeans in RUSLE2 databases, so soybeans using a moldboard plow and a twist shovel plow, both at 35 bu/ac, were used in the analysis. In total, six crop types were selected to be used in the RUSLE2 analysis: Alfalfa, Corn (150 bu/ac (370.7 bu/ha)), Corn (224 bu/ac (553.5 bu/ha)), Soybeans (35 bu/ac (86.5 bu/ha) w/ moldboard plow), Soybeans (35 bu/ac (86.5 bu/a) w/ twist shovel plow), and Winter Wheat (45 bu/ac (111.2 bu/ha)).

#### **2.3.4.3 Slopes**

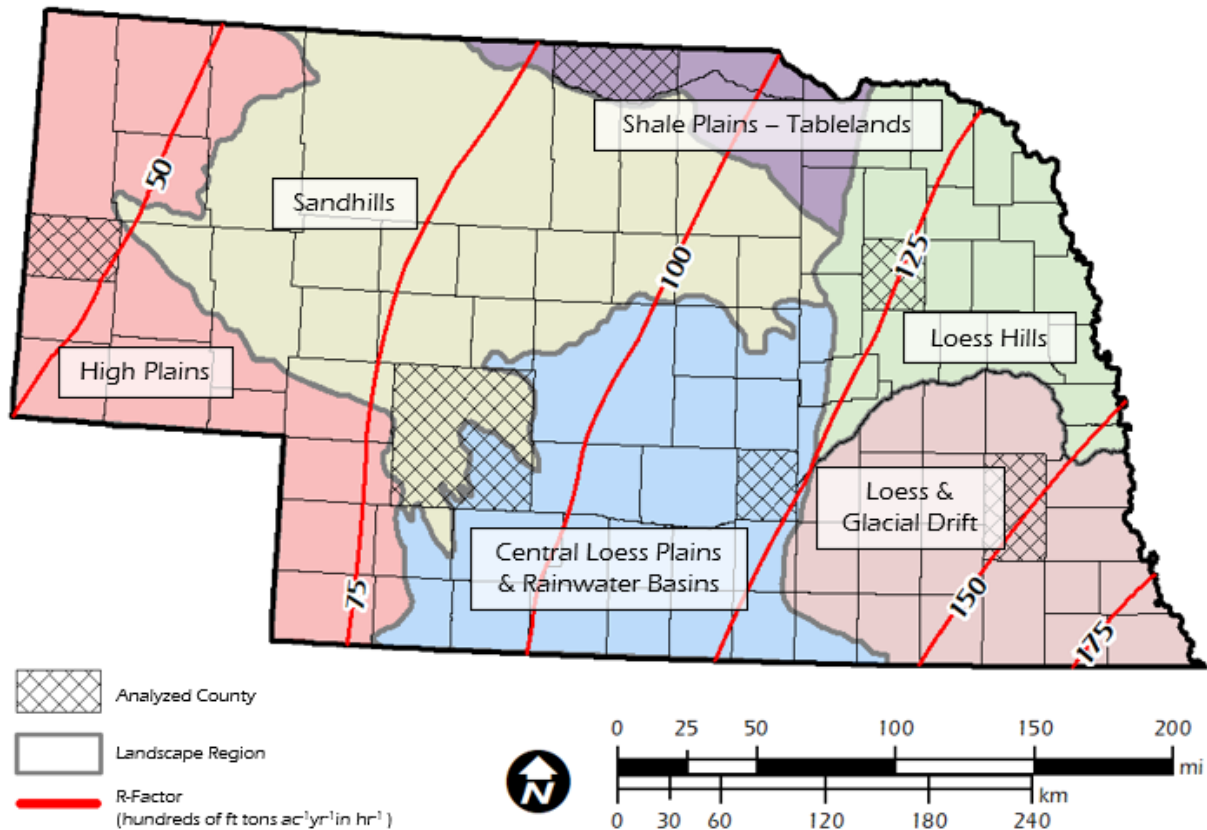
Slopes of the vegetated buffer and simulated construction site were adjusted independently. Slopes of 1%, 5%, and 10% were used for the vegetated buffers. Steeper slopes would facilitate channelized flow, which vegetation cannot easily slow and facilitate deposition.

Slopes for the simulated construction site upstream of the buffer were selected as 10%, 25%, 33%, and 45% to represent conditions commonly found on roadway construction projects. These different slopes will allow for the analysis of different amounts of sediment passing through the vegetated buffer on capture; for example, a slope of 45% will produce over eight times the amount of soil loss than a slope of 10% (Renard et al. 1997).

#### **2.3.4.4 Climate and Rainfall**

Due to the wide variation in rainfall across the state, different areas had to be analyzed. RUSLE2 contains counties in every state for climate conditions, including six in Nebraska. Each county used in the analysis was located primarily in one of the six different landscape areas. Figure 2.3 shows the distribution of counties considered, along with the annual rainfall erosivity factor and the six landscape regions of Nebraska.





**Figure 2.3 Distribution of Analyzed Counties, Landscape Regions, and Annual Rainfall Erosivity**

#### 2.3.4.5 Summary of Factors

From the analysis of the study area and factors relevant to soil loss and deposition, nine soil series, four site slopes, three buffer slopes, eighteen species or mixes of vegetations, and six locations were chosen to be analyzed to ensure coverage of the study area and allow for data to apply to more site conditions. Table 2.2 shows the full summary of factors selected for analysis, as well as the total number of factors considered in each category.

**Table 2.2 Summary of Factors**

<b>Soil Series (9)</b>	Valentine Fine Sand, Holdrege Silt Loam, Hastings Silt Loam, Uly-Coly Silt Loam, Moody Silty Clay Loam, Valent Sand, Coly Silt Loam, Crete Silt Loam, Wymore Silty Clay Loam
<b>Site Slope (4)</b>	10:1, 4:1, 3:1, 2:1
<b>Buffer Slope (3)</b>	1%, 5%, 10%
<b>Vegetation / Crops (18)</b>	Dense Grass, Continuous Mixed Grasses, Continuous Gramma, Range grass four years after last disturbance, Big Bluestem, Kentucky Bluegrass and Clover, Orchardgrass and Legume, Red Clover, Reed Canary Grass, Switchgrass, Tall Fescue, Timothy Alfalfa, Corn (150 bu/ac), Corn (224 bu/ac), Soybeans (35 bu/ac w/ moldboard plow), Soybeans (35 bu/ac twist shovel plow), Winter wheat (45 bu/ac)
<b>Location (6)</b>	Hall County, Keya Paha County, Madison County, Lancaster County, Lincoln County, Scotts Bluff County

### 2.3.5 Determining Efficiency

Using a Python script and the list of factors selected above, a Microsoft Excel spreadsheet of every possible combination of buffer configurations was generated, resulting in 7,776 unique buffer combinations of grass and grass-like vegetations and 3,888 buffer combinations of row crops for analysis. For each buffer configuration, the soil loss in the upstream simulated construction site and the sediment yield at the end of the buffer were recorded, all in tons/ac/yr (tonnes/ha/yr). These values were used in Eq. 2.3 to determine the percent sediment capture.

$$SC = \frac{SL - SY}{SL} \times 100\% \quad (\text{Eq. 2.3})$$

Where,

SC = Percent Sediment Captured within Buffer

SL = Soil Lost due to Erosive Forces in Upstream Construction Site (tons/ac/yr [tonnes/ha/yr])

SY = Sediment Yield at End of Vegetated Buffer (tons/ac/yr [tonnes/ha/yr])

### **2.3.6 Summary**

This section provides an outline of the process by which vegetated buffers on highway construction projects in Nebraska were analyzed. In total, 11,664 vegetated buffer configurations were identified and analyzed, generating a dataset on sediment removal capabilities of 50 ft (15 m) undisturbed vegetative buffers under different conditions local to Nebraska highway construction projects. Appendix A gives the results for each buffer configuration, ordered from buffers capturing the highest percentage of sediment to the least effective. The data generated using this methodology will allow for identifying secondary controls to reach the USEPA and NDEE regulatory requirements of matching the sediment removal capabilities of a 50 ft (15 m) undisturbed vegetated buffer (Ducey and Patrick 2021; USEPA 2022a). Additionally, this methodology can easily be replicated for other states or regions to determine the sediment removal capabilities of local buffer conditions by identifying local factors and running RUSLE2 analysis.

### **2.4 Results of Modeling of Undisturbed Vegetated Buffers in Sediment Removal**

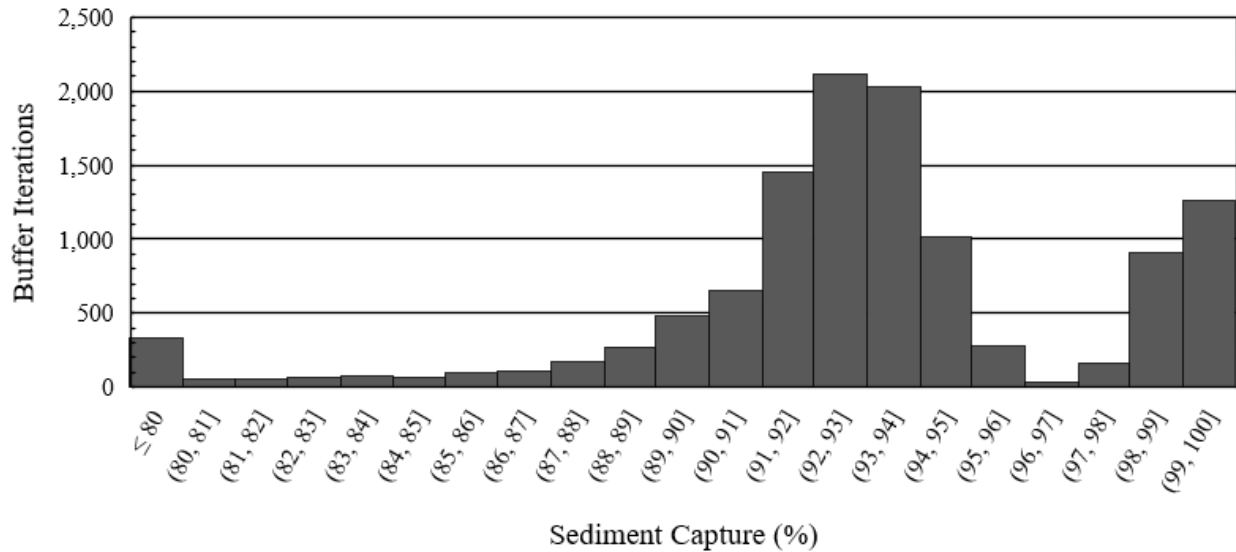
Modeling results are shown in Table 2.3, with the mean, minimum, maximum, standard deviation, and count for all factors. The results are shown for each factor to show the effect of each factor on sediment capture. The maximum sediment capture found among analyzed buffers was 99.48%, which occurred on four modeled buffers, each of which was under conditions local to Scotts Bluff County (the county analyzed that receives the lowest annual rainfall) and had an upstream site slope of 4:1, a buffer slope of 1%, soil of Valentine Fine Sand, and buffers of dense grass, Reed Canary grass, Tall Fescue, or Timothy. The lowest capture was 18.46% in a buffer under conditions local to Scotts Bluff County, an upstream site slope of 10:1, a buffer slope of 10%, soil of Valentine Fine sand, and cover of soybeans at 35 bu/ac (86.5 bu/ha) planted

using a moldboard plow. It should be noted that the worst-case capture by percentage occurred under the conditions that produced the least overall soil loss on the simulated construction site upstream of the buffer: a simulated construction site with a 10:1 slope consisting of Valentine fine sand, the least easily mobilized soil analyzed and located in the county analyzed with the least amount of rainfall only produced soil loss of 6.5 tons/ac/yr (16.1 tonnes/ha/yr), while some under less favorable conditions produced soil loss of over 900 tons/ac/yr (2234 tonnes/ha/yr).

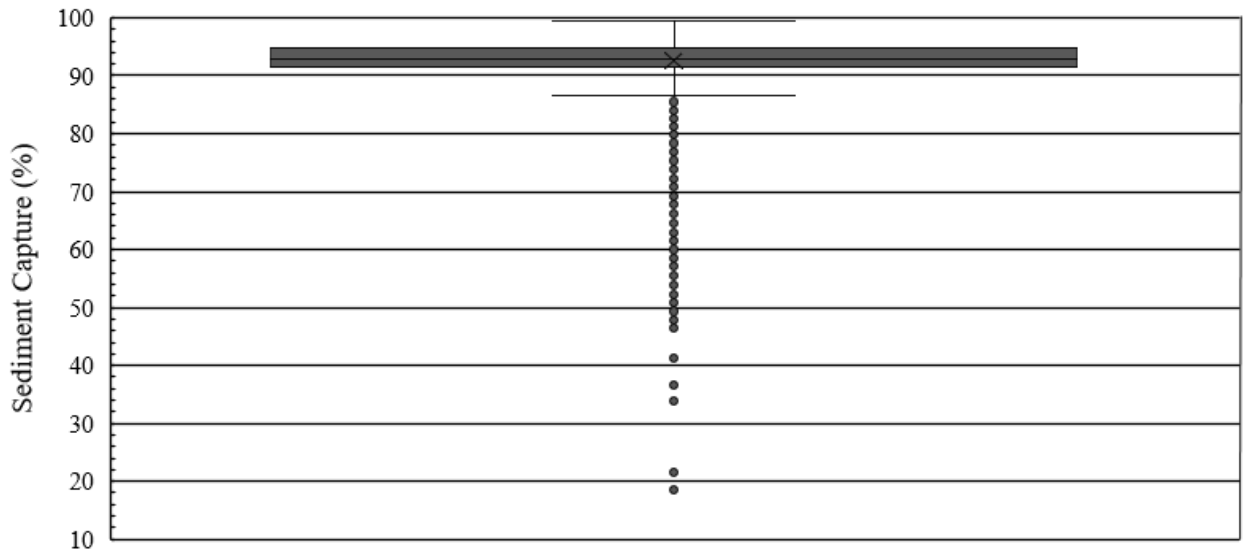
**Table 2.3 Vegetated Buffer Modeling Results**

<b>Soil Series</b>	<b>n</b>	<b>Mean (%)</b>	<b>Min (%)</b>	<b>Max (%)</b>	<b>Std Dev (%)</b>
Coly Silt Loam	1,296	91.02	46.36	95.43	5.39
Crete Silt Loam	1,296	91.05	48.96	94.92	5.13
Hastings Silt Loam	1,296	91.59	48.91	95.13	5.14
Holdrege Silt Loam	1,296	91.24	47.37	95.2	5.17
Moody Silty Clay Loam	1,296	90.39	50	94	4.73
Uly-Coly Silt Loam	1,296	92.23	47	95.93	5.32
Wymore Silty Clay Loam	1,296	90.85	54.84	93.33	4.36
Valent Sand	1,296	97.53	21.54	99.3	6.21
Valentine Fine Sand	1,296	97.64	18.46	99.48	6.32
<b>Site Slope</b>	<b>n</b>	<b>Mean (%)</b>	<b>Min (%)</b>	<b>Max (%)</b>	<b>Std Dev (%)</b>
10:01	2,916	89.71	18.46	99.45	9.80
4:01	2,916	93.23	63.33	99.48	3.87
3:01	2,916	93.61	82.09	99.45	3.37
2:01	2,916	93.9	84.78	99.47	3.08
<b>Buffer Slope</b>	<b>n</b>	<b>Mean (%)</b>	<b>Min (%)</b>	<b>Max (%)</b>	<b>Std Dev (%)</b>
1%	3,888	94.35	77.14	99.48	2.78
5%	3,888	92.97	70.77	99.44	4.22
10%	3,888	90.53	18.46	99.42	8.60
<b>Vegetation</b>	<b>n</b>	<b>Mean (%)</b>	<b>Min (%)</b>	<b>Max (%)</b>	<b>Std Dev (%)</b>
Big Bluestem	648	93.56	83.57	99.44	3.33
Continuous Gramma	648	92.51	80	99.41	4.01
Continuous Mixed Grasses	648	93.74	85.67	99.44	3.19
Dense Grass	648	94.56	90.1	99.48	2.68
Kentucky Bluegrass and Clover	648	94.23	88.57	99.45	2.81
Orchardgrass and Legume	648	94.52	90	99.47	2.70
Range Grass 4 years after last disturbance	648	94.18	89.24	99.45	2.92
Red Clover	648	92.37	77.14	99.42	4.71
Reed Canarygrass	648	94.57	90	99.48	2.69
Switchgrass	648	93.96	86.43	99.44	3.00
Tall Fescue	648	94.65	88.06	99.48	2.68
Timothy	648	94.62	90.52	99.48	2.68
Alfalfa	648	93.75	85.83	99.42	2.97
Corn (150 bu/ac)	648	89.22	49.23	99.02	8.50
Corn (224 bu/ac)	648	90.63	67.86	99.16	6.56
Soybeans (35 bu/ac w/ moldboard plow)	648	85.74	18.46	98.9	12.61
Soybeans (35 bu/ac twist shovel plow)	648	87.79	33.85	98.95	10.20
Winter Wheat (45 bu/ac)	648	92.52	78.57	99.37	4.26
<b>Location</b>	<b>n</b>	<b>Mean (%)</b>	<b>Min (%)</b>	<b>Max (%)</b>	<b>Std Dev (%)</b>
Hall County	1,944	92.2	48.45	99.45	5.90
Keya Paha County	1,944	92.78	41.18	99.44	5.76
Lancaster County	1,944	91.4	50.91	99.43	6.03
Lincoln County	1,944	92.81	34.00	99.43	6.10
Madison County	1,944	92.7	46.36	99.44	5.96
Scotts Bluff County	1,944	93.79	18.46	99.48	5.91
<b>Total</b>	<b>n</b>	<b>Mean (%)</b>	<b>Min (%)</b>	<b>Max (%)</b>	<b>Std Dev (%)</b>
Total	11,664	92.62	18.46	99.48	5.99

The distribution of all buffer iterations modeled is shown in Figure 2.4. The spread of performance of buffer iterations indicates that half of the buffers modeled captured between 91 and 93% of introduced sediment. The spread suggests a normal distribution for many of the buffers; however, a second peak of capture values is apparent between 98 and 100% of sediment capture, which represents buffers with sandy soils. At approximately 90% sediment capture, there is a drop-off of buffer iterations; only 13.8% of modeled buffers captured under 90% of introduced sediment.



(a) histogram of buffer iterations



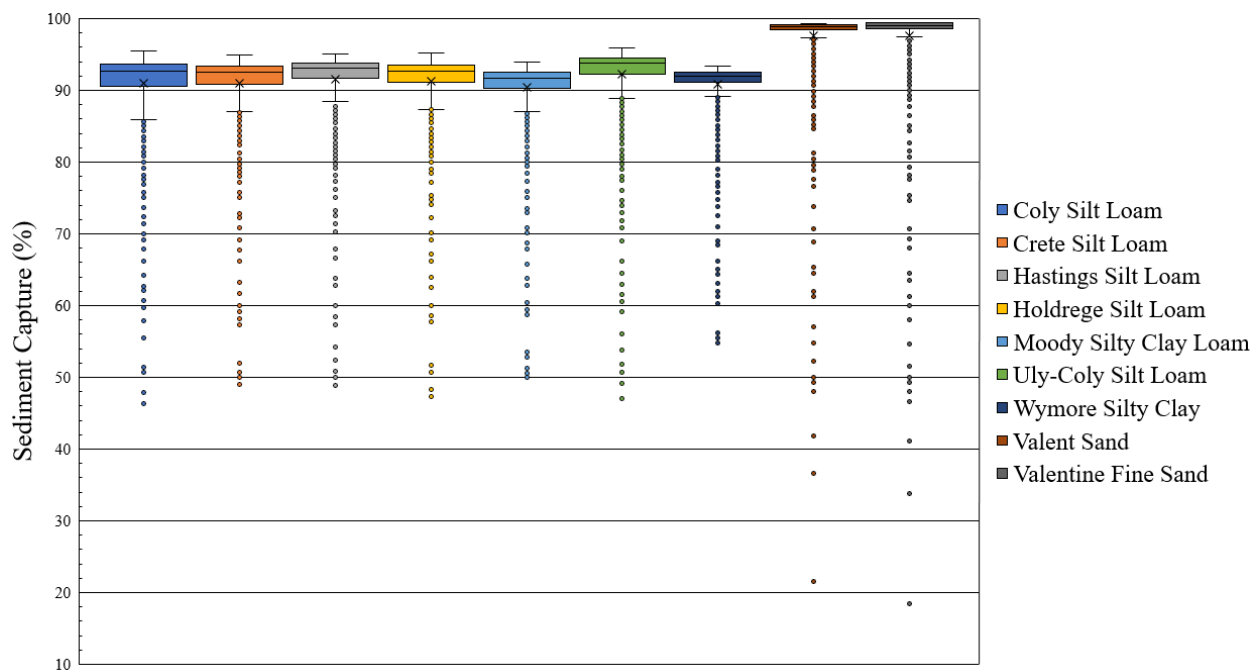
(b) box plot of buffer iterations

**Figure 2.4: Buffer Iteration Distribution**

### 2.4.1 Effects of Soil Characteristics on Sediment Capture

Of the nine soil series investigated, a similar capture was indicated between soils of the same texture. The two silty clay loams had the least amount of capture on average within vegetated buffers modeled with average captures of 90.39% and 90.85%. Each of the five silt loams modeled had between 91% and 92.3% sediment capture. The two sandy soils had the highest average capture within the buffers at 97.53% and 97.64%. Figure 2.5 shows the

distribution of the 1,296 buffer iterations per soil series analyzed. The spread of all the silt loams and silty clay loams was similar, with minimums between 46.36% and 54.84% and maximums between 93.33% and 95.93%. However, the sandy soils, despite having the highest average and a lower first quartile than the maximum sediment capture for all other modeled soils, had the lowest minimum sediment capture, due to the analysis being conducted on a percentage basis, comparing the yield to the introduced sediment instead of comparing the overall yield between buffers of different soil types.



**Figure 2.5: Sediment Capture Distributions of Buffer Iterations by Soil Series**

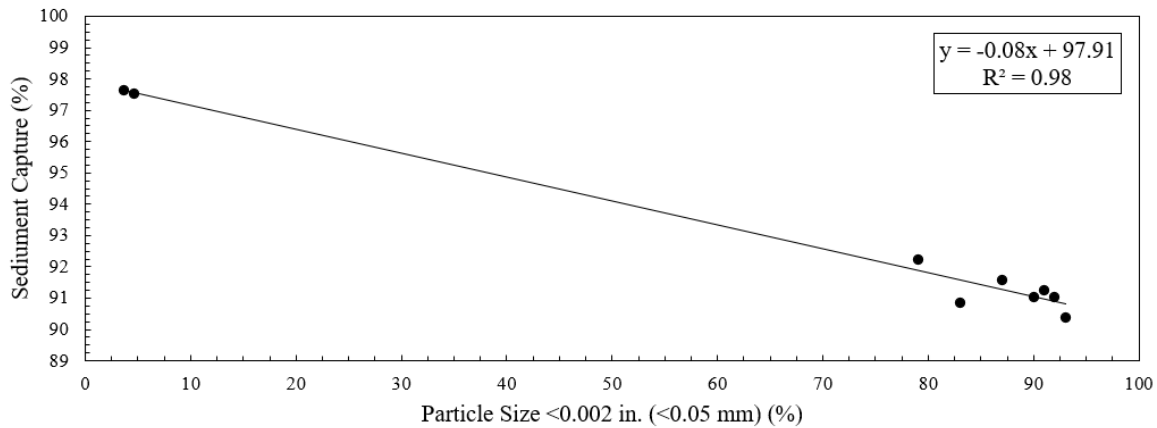
As shown in Table 2.4, the soil loss on the upstream modeled construction site is less for sites with sandy soil than the silty clay loams and silt loams investigated. All the buffer iterations modeled with sandy soils with capture of under 50% had a sediment delivery under the average sediment delivery from other soils.



**Table 2.4: Sediment Loading and Capture by Soil Texture**

Soil Texture	Average Soil Loss (tons/ac/yr [tonnes/ha/yr])	Average Sediment Delivery (tons/ac/yr [tonnes/ha/yr])	Average Sediment Capture (%)
Silt Loams	312.97 [701.59]	25.57 [57.32]	91.42
Silty Clay Loams	226.08 [506.80]	20.29 [45.48]	90.51
Sands	78.75 [176.53]	1.26 [2.82]	97.60

The increased capture percentage, as well as the lower sediment load introduced and delivered through the vegetated buffer, are due to the larger average size particles and lower composition of fine particles of the sandy soils compared to the silty clay loams and silt loams. The larger soil size causes the sandy soils to be more easily capturable within the vegetated buffer due to requiring less velocity reduction to fall out of suspension (Weiss et al. 2013; Xiao et al. 2017).



**Figure 2.6: Average Sediment Capture by Percent Fines**

Figure 2.6 shows the strong, linear relation between average sediment capture and the composition of fines (soil particles under 0.0002 in. (0.05 mm)) of each soil series modeled. The strong relationship ( $R^2 = 0.98$ ) indicates that as the soil has more fines, the sediment capture within a buffer decreases on average. The Valent Sand and Valentine Fine Sand have only 4.6% and 3.7% fines, respectively, and were captured at a statistically significant higher rate. The

results of an unpaired t-test are shown in Table 2.5; the percentage capture of the sands was significantly higher than the percentage capture of the silt loams and silty clay loams used in the analysis in a 99% confidence t-test due to the p-value of the test being below 0.01 and effectively 0.

**Table 2.5: Comparison of Capture of Sandy Soil and All Other Soils**

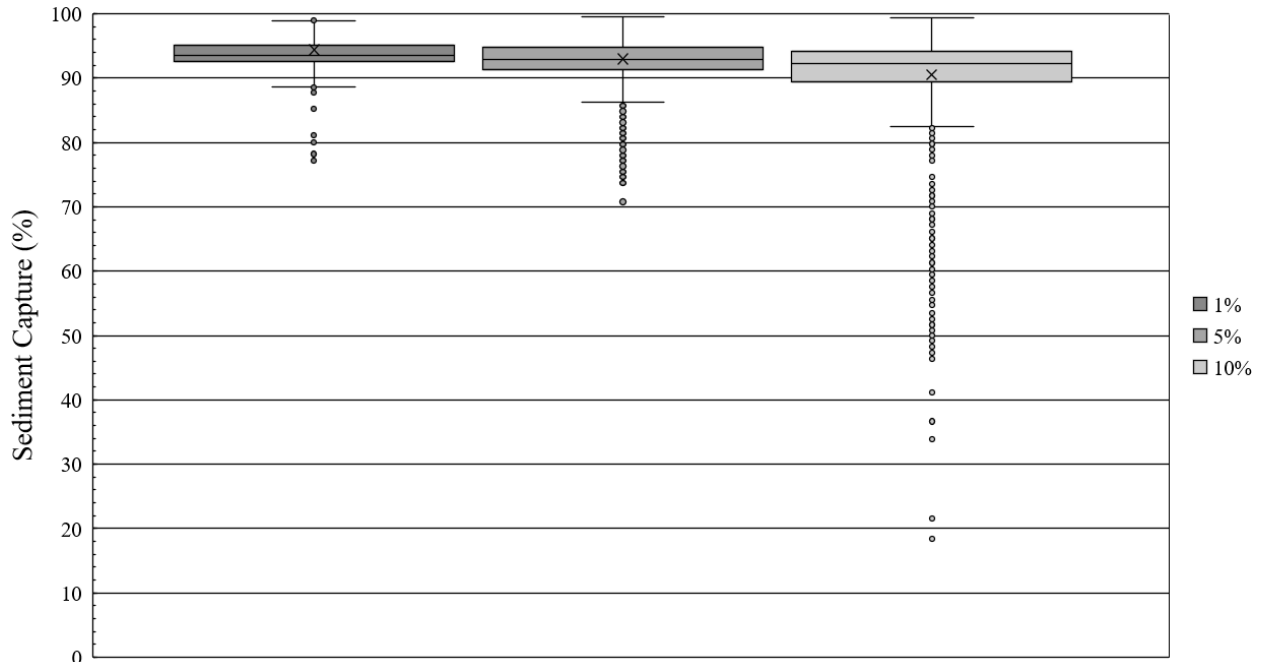
<b>Average Capture of Sandy Soils (%)</b>	<b>Std. Dev of Capture of Sandy Soils (%)</b>	<b>n sands</b>	<b>Average of Remaining Soils (%)</b>	<b>Std. Dev. of Capture of other soils (%)</b>	<b>n other</b>	<b>Degrees of Freedom</b>	<b>T-stat</b>	<b>P-value</b>
97.59	6.27	2,592	91.18	5.08	9,072	3,616	47.62	0

The analysis of capture rates of common soil series in Nebraska within vegetated buffers follows past research in indicating that the larger particles within the soil running off construction sites are more easily capturable within vegetated buffers due to the increased fall velocity of the sediment particles.

#### **2.4.2 Effects of Buffer and Site Slope on Sediment Capture**

The steepest buffer slope analyzed, 10%, had the lowest average percent capture, 90.53%, and the highest standard deviation of capture, 8.60%, likely as a result of increased flow velocity pushing vegetation down and leading to the buffer being less like to experience laminar flow. Figure 2.7 shows the distribution of sediment capture within buffers of each slope. Average sediment capture within the buffers modeled decreased as the slope of the buffer decreased, with the average sediment capture of the 10% being 90.53% and the average sediment capture of the 1% buffers being 94.34%. Additionally, the minimum sediment capture decreased as buffers became steeper. This decrease in sediment capture efficiency matches past research, which found that a steeper buffer slope leads to higher velocity flow, allowing for less sediment deposition,

while also justifying vegetated buffer regulations that are based on slopes, such as those in North Carolina (State of North Carolina Department of Environmental Quality Division of Energy 2019).



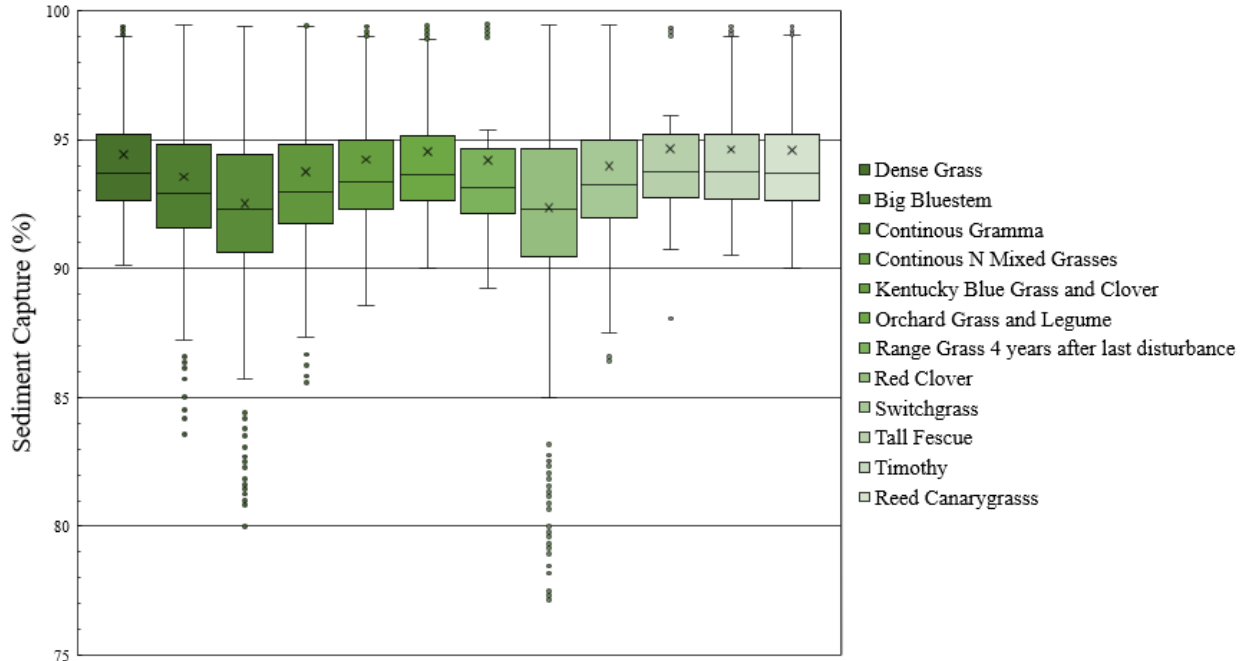
**Figure 2.7: Average Sediment Capture by Buffer Slope**

Except for the 10:1 upstream simulated construction site slope, there was little variation between the average and distribution of sediment capture percentages. The 10:1 slope had the lowest average sediment capture rate at 89.71%, while the other three steeper slopes all had averages between 93.23% and 93.90%. The reduced slope of simulated construction sites caused far less soil loss, with the 10:1 site slope having an average soil loss of 60 tons/ac/yr (135 tonnes/ha/yr) and the 4:1 site slope having an average soil loss of 401 tons/ac/yr (899 tonnes/ha/yr). Due to the shallower 10:1 slopes having less risk of erosion than other slopes, the detached sediment particles experienced in runoff by buffers downstream from such slopes would be finer and harder to deposit or infiltration within the vegetated buffer on average than

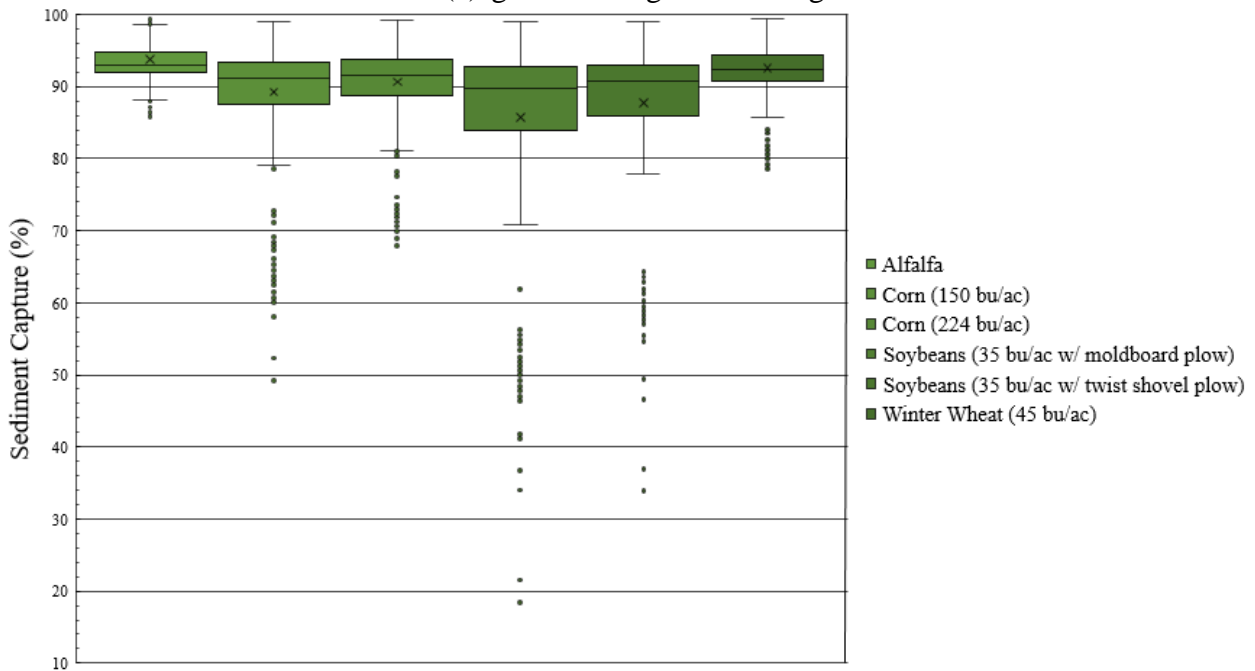
larger particles experienced in runoff from slopes that are more at risk to erosion and sediment-laden runoff.

### **2.4.3 Effects of Vegetation on Sediment Capture**

Natural grasses and row crops modeled for sediment capture within vegetated buffers varied in sediment capture. Figure 2.8 shows the distribution of sediment capture within buffers of each vegetation type. On average, capture within buffers consisting of the 12 grasses and grass-like vegetation had a higher average, 93.96%, than buffers consisting of the 6 row crops analyzed, averaging 89.94%. Additionally, the row crops, especially the two densities of corn and two methods of planting soybeans, had a much larger distribution of buffer iterations.



(a) grasses and grass-like vegetation



(b) row crops

**Figure 2.8: Average Sediment Capture by Vegetation Type**

Among the grasses and grass-like vegetation, continuous gramma and red clover had the lowest sediment capture, especially when the buffer slope was at its steepest at 10%, and the soil was composed of more fine particles, such as silt loam or silty clay loams. For grasses and grass-

like vegetation, all scenarios for which the sediment capture was under 85% had a buffer of either red clover, grama, or big bluestem, with 93.8% of these buffers having a 10% slope. Within buffers consisting of grasses and grass-like vegetation, there was a weak linear relationship ( $R^2 = 0.28$ ) between sediment capture and above-ground biomass, with sediment capture increasing as biomass increased; variation within this relationship is likely the result of vegetations being treated differently within RUSLE2 and the complexity of the cover factor within the program, considering height, density, root mass, etc.

Row crops, in addition to capturing less sediment on average, had a wider distribution of capture within buffer iterations, ranging from 99.4% to as low as 18.5%. The buffers that facilitated the least amount of sediment capture were typically composed of soybeans; all but one buffer that captured less than 50% of introduced sediment was composed of soybeans, except a single buffer composed of corn. The higher density corn, 225 bu/ac (553.5 bu/ha), captured more introduced sediment on average than the 150 bu/ac (370.7 bu/ha) density corn while also having a higher minimum capture rate of 67.86% of introduced sediment compared to 49.23% of the 150 bu/ac (370.7 bu/ha) corn. The decreased performance of crops compared to grasses and grass-like vegetation is likely due to the decreased density of the vegetation closest to the ground, with areas between rows of crops mostly uncovered.

#### **2.4.4 Effects of Climate on Sediment Capture**

Due to the state of Nebraska having a varied climate, with areas in the far west of the state receiving as little as half of the rainfall of the southeastern corner, the six counties showed varied sediment capture and loading on modeled vegetated buffers. Table 2.6 shows the average and minimum sediment capture, soil loss on the simulated construction site up-slope of buffers, the rainfall erosivity factor, and the average annual precipitation for each of the analyzed counties.

Modeling results indicate that, on average, as an area receives more rainfall, a higher percentage of the introduced sediment is captured; however, less sediment is introduced due to having lower average soil loss on the slope directly upstream of the buffer. A strong negative linear relationship ( $R^2 = 0.88$ ) was shown between sediment capture and the rainfall erosivity factor, with the percent capture dropping a percentage point on average when the rainfall erosivity factor increases by 52 hundreds of ft tons ac<sup>-1</sup> yr<sup>-1</sup> in hr<sup>-1</sup> (885 MJ mm ha<sup>-1</sup> yr<sup>-1</sup> hr<sup>-1</sup>). The minimum sediment capture also decreases as an area receives less rainfall, showing the opposite pattern of the average; however, this is due to cases where very little soil loss occurs. For example, the four buffer iterations modeled with under 34% sediment capture, all occurring in conditions local to Scotts Bluff County, had soil loss on the upstream simulated construction site of only 6.5 tons/ac/yr (14.6 tonnes/ha/yr).

**Table 2.6: Comparison of Sediment Capture and Soil Loss by Location**

Location (County)	Average Sediment Capture (%)	Minimum Sediment Capture (%)	Soil Loss (tons/ac/yr [tonnes/ha/yr])	Rainfall Erosivity Factor (hundreds of ft tons ac <sup>-1</sup> yr <sup>-1</sup> in hr <sup>-1</sup> [MJ mm ha <sup>-1</sup> yr <sup>-1</sup> hr <sup>-1</sup> ])	Average Annual Precipitation (in. [cm])
Scotts Bluff	93.79	18.46	77.84 [174.5]	42.65 [725.9]	14.9 [37.9]
Lincoln	92.81	34.00	183.2 [410.7]	85.52 [1,455.6]	20.0 [50.8]
Keya Peha	92.78	41.18	205.06 [459.7]	92.54 [1,575.0]	21.8 [55.4]
Madison	92.70	46.36	301.28 [675.4]	124.38 [2,116.9]	26.0 [66.0]
Hall	92.20	48.45	308.71 [692.0]	126.91 [2,160.0]	25.9 [65.8]
Lancaster	91.40	50.91	373.62 [837.5]	149.81 [2,549.8]	29.6 [75.2]

*Note: Rainfall Erosivity Factor and Average Annual Precipitation are from RUSLE2*

Past research on vegetated buffers indicated that areas that experience increased average rainfall have buffers that perform worse in removing suspended sediment from sediment-laden stormwater flow, due to higher flows being more difficult for vegetation to slow and higher

moisture content in soils leading to decreased infiltration. Modeling of vegetated buffers through RUSLE2 matches completed testing and modeling by indicating decreased performance in buffers in locations within Nebraska that experience more rainfall on average.

#### **2.4.5 Multiple Linear Regression Model**

To statistically determine the relevance and impact of each of the modeled factors that impact sediment capture within a 50 ft (15 m) vegetated buffer, a multiple linear regression model was chosen. However, due to the clear difference in performance between buffers composed of grasses and grass-like vegetation and those composed of row crops, the two vegetation categories were analyzed separately.

Variables included in the analysis of the 7,776 buffers composed of grasses and grass-like vegetations were (1) slope of the upstream, disturbed simulated construction site, (2) slope of the vegetated buffer, (3) density of the above-ground vegetation in lb/ac (kg/ha), (4) percent fines within the soil, and (5) the annual rainfall erosivity. The dependent variable was sediment capture within the vegetated buffer. A base condition of zero sediment capture, representing a bare area with no vegetation, was used for analysis. In actuality, a bare area with no vegetation would not only facilitate little to no sediment capture but would also have erosion experienced, leading to higher sediment loading downstream; however, in this analysis, only capture was modeled. A moderately well-fit linear model ( $R^2 = 0.80$ ) was generated when compared to the results of RUSLE2 modeling. A summary of the model is given in Table 2.7. All variables investigated were statistically significant at a 95% confidence interval due to all P-values being under 0.05. Table 2.7 shows a summary of the linear regression model generated. Based on the model, decreasing the buffer slope and decreasing the amount of smaller soil particles in runoff facilitates greater sediment capture due to the negative and positive coefficients, respectively.



Increasing the amount of sediment loading in the runoff experienced by buffers increased the sediment capture, evidenced by the site slope and rainfall erosivity factors, which are the two factors that impact soil loss upstream, having positive coefficients. As evidenced by the low coefficient and highest p-value of the factors analyzed, vegetation density had the weakest correlation of all factors, with increased maximum above-ground biomass decreasing sediment capture.

**Table 2.7: Summary of Linear Regression Model for Grasses**

Buffer Characteristic	Statistical significance	
	Coefficient	P-Value
Base Condition	0	NA
Site Slope (%)	5.76	0
Buffer Slope (%)	-7.86	4.02E-91
Vegetation (lb/ac [kg/ha])	-0.00882 [-0.00989]	1.65E-81
Soil Fines (%)	1.14	1.12E-181
Rainfall Erosivity (hundreds of ft tons ac <sup>-1</sup> yr <sup>-1</sup> in hr <sup>-1</sup> [MJ mm ha <sup>-1</sup> yr <sup>-1</sup> hr <sup>-1</sup> ])	0.906 [15.42]	1.77E-151

*Note: NA = not applicable*

Analysis of the row crops was conducted in the same way; however, bushels per acre was used as the unit to represent the vegetation density, due to that being the primary agricultural unit used. The multiple linear regression model for crops was also moderately well-fit ( $R^2 = 0.81$ ) compared to the results of the RUSLE2 modeling. Table 2.8 shows the summary of the model for crops. All factors considered were also statistically significant at a 95% confidence interval. In comparison with the buffers consisting of grasses, increasing steepness of the buffer had more drastic of an effect on reducing sediment capture, due to having a higher negative coefficient.

**Table 2.8: Summary of Linear Regression Model for Row Crops**

Buffer Characteristic	Statistical significance	
	Coefficient	P-Value
Base Condition	0	NA
Site Slope (%)	5.64	1.2E-306
Buffer Slope (%)	-9.29	2.01E-64
Vegetation (lb/ac [kg/ha])	-0.00747 [-0.00837]	2.36E-42
Soil Fines (%)	1.08	1.18E-89
Rainfall Erosivity (hundreds of ft tons ac <sup>-1</sup> yr <sup>-1</sup> in hr <sup>-1</sup> [MJ mm ha <sup>-1</sup> yr <sup>-1</sup> hr <sup>-1</sup> ])	0.863 [14.69]	1.06E-76

*Note: NA = not applicable*

## **2.5 Usable Tool for Vegetated Buffer Sediment Removal Analysis**

To allow designers and regulators to determine the sediment removal performance of a site-specific buffer to design alternative sediment controls, a usable Excel tool was developed that delivers the user the sediment loading, yield, and removal of a buffer with given conditions that were used within modeling. The tool consists of a pivot table that allows for selecting factors to output the capture, sediment yield, and soil loss for the buffer selected. In the event of site-specific conditions not perfectly matching any of the modeled conditions, multiple or all modeled conditions can be selected, and average results for all modeled conditions meeting the selected conditions will be displayed. Information on soil series modeled and locations used are also included to aid designers in selecting conditions that best represent buffers on their site. For example, if the location of a buffer that a designer would like to see the performance of is not in a county shown, multiple can be selected to find an average close to the location wanted. Figure 2.9 shows a screen capture of the tool. This example shows the average buffer performance of a 5% sloped vegetated buffer consisting of grass immediately downstream of a 4:1 construction site with soil of Moody Silty Clay Loam and located in Hall County, Nebraska; results from modeling indicate that on average, a buffer of those conditions would experience a sediment loading of 281.67 tons/ac/yr (631.42 tonnes/ha/yr), a sediment yield at the end of the buffer of 24.00 tons/ac/yr (53.80 tonnes/ha/yr), and an average sediment capture of 91.5%.

Factor Selection	
Upstream Slope (%)	25
Slope of Buffer (%)	5
Vegetation	(Multiple Items)
Soil	Moody silty clay loam
Location	Hall

Location	
County	R-Factor
Scotts Bluff	42.646
Lincoln	85.519
Keya Paha	92.536
Madison	124.384
Hall	126.91
Lancaster	149.81

Average Soil Loss (t/ac/yr)	Average Sediment Yield (t/ac/yr)	Average Capture
281.67	24.00	0.915

Soil Type				
Soil Series	% Sand (0.05-2 mm)	% Silt (0.002-0.05)	% Clay (<0.002)	% Fines
Coly Silt Loam	8	71	21	92
Crete Silt Loam	7	69	21	90
Hastings Silt Loam	13	63	24	87
Holdrege Silt Loam	9.4	67	24	91
Moody Silty Clay Loam	6.9	62	31	93
Uly-Coly Silt Loam	21	58	21	79
Swymore Silty Clay	17	48	35	83
Valent Sand	95	0.6	4	4.6
Valentine Fine Sand	96	0.7	3	3.7

**Figure 2.9 Vegetated Buffer Performance Tool**

## 2.6 Summary

This chapter outlined the process and results of RUSLE2 modeling of various vegetated buffer configurations local to Nebraska highway construction projects. The 11,664 buffers modeled for sediment removal performance averaged 92.62% removal of introduced sediment, indicating that 50 ft (15 m) undisturbed vegetated buffers can be highly effective in removing suspended sediment and protecting neighboring waterbodies. All of the factors analyzed within buffer iterations (slopes, vegetation, location, and soils) played a role in determining the performance of buffer iterations. Increasing the steepness of buffers and increasing the sediment-laden stormwater loading on vegetated buffers decreased the percentage of sediment introduced that was captured within buffers. The considerable variation of performance between buffers indicates that a “one-size fits all” approach to vegetated buffers in sediment control is likely not the most effective or feasible approach to regulations and guidelines; regulations that take into account buffer conditions, such as local soil types, slopes, and vegetation can lead to more cost-effective buffers in conditions where protection could be possible with less space and increased

protection for buffer conditions where 50 ft (15 m) may not be enough room to effectively remove sediment from flow, such as cases where the buffers are composed of row crops.

Despite a large number of buffers being modeled, this modeling effort has limitations. The review of past research found that one of the most important factors in the repeated performance of vegetated buffers is maintenance; poorly maintained buffers, such as those that become disturbed due to equipment or lose vegetation density due to poor irrigation, will perform poorly in sediment capture. In this analysis, sediment capture was investigated as a percentage, which can lead to misleading results. For example, buffers adjacent to sites with less erosion risk might have lower capture percentages while also having far lower amounts of sediment passing through the buffer.

The modeling process outlined in this chapter can be repeatable for other areas of the country by using conditions local to that area, many of which are in RUSLE2 or are importable to the software, to determine vegetated buffer performance. Additionally, the modeling results show the required performance of sediment barriers employed as alternatives to the 50 ft (15 m) undisturbed vegetated buffer requirements outlined in the CGP.

## **Chapter 3: Large-Scale Performance Evaluation of Sediment Barriers**

### **3.1 Introduction**

Sediment barriers are typically designed and installed under rules of thumb and have little to no scientific testing to provide implementation guidance. The little testing that has occurred has outlined severe deficiencies in the ability of sediment barriers to protect downstream areas from sediment-laden stormwater runoff (Kaufman 2000; Liu et al. 2021). Additionally, the considerable variation of site conditions across the United States that sediment barriers experience leads to large variations in designs being required to have installations that are both effective and feasible. The testing that has been conducted has also been primarily testing conditions and standards local to the Southeastern United States; there is little testing on barriers and conditions to the Midwestern United States. This chapter aims to provide background on the purpose and types of sediment barriers, outline past sediment barrier testing efforts, develop a testing methodology for large-scale performance testing of Nebraska DOT sediment barriers, and give results of testing.

### **3.2 Sediment Barrier Literature Review**

Sediment barrier testing typically can be divided into three categories: small-scale testing, field monitoring, and large-scale laboratory testing. All three aim to determine the efficiency of sediment barrier installations in different manners, with small-scale typically determining the effectiveness of geotextile material or other components individually and field and large-scale testing determining the effectiveness of the installation as a whole. Numerous types of sediment barrier installations have been evaluated through the three types of testing including silt fence, wattles, sandbags, hay bales, and others.

### **3.2.1 Common Installed Sediment Barrier Practices**

Sediment barriers are commonly used to aid or replace the sediment capture capabilities of vegetated buffers. However, the conditions a sediment barrier can experience on-site vary widely based on the location and hydrological conditions experienced (Perez et al. 2016). Due to these variations, there are numerous available sediment barrier options and variations of installations. Typically, state DOTs offer guidance in ESC or stormwater management manuals on requirements, installation details, and recommendations for sediment barrier installations. To summarize the different sediment barrier practices used across the United States, a review was conducted by Troxel in 2013 of 49 Department of Transportation (DOT) manuals. Each of the manuals outlined silt fence as an acceptable sediment barrier practice. Other sediment barrier installations, such as hay or straw bales, berms of various materials, diversion ditches, sediment traps, wattles, sandbags, and silt dikes, were also outlined as acceptable practices for numerous other states (Burns and Troxel 2015).

### **3.2.2 Silt Fence**

Silt fences are composed of a geotextile fabric attached to posts; geotextile fabric, means of attachment, and post material can vary. The purpose of silt fence installations is to intercept sediment-laden stormwater runoff and form impoundment to facilitate sedimentation to keep eroded soil on site and prevent pollution of natural water bodies and municipal stormwater systems. Silt fence is typically installed at the toes of slopes and on the perimeter of sites; long runs of fence often include j-hooks to allow for more storage area of impoundment and sediment. Installation is completed by trenching the fabric in manually or using a slicing machine to insert the fabric into the ground (USEPA 2021a). Figure 3.1 shows a silt fence installation on a Nebraska DOT highway project.

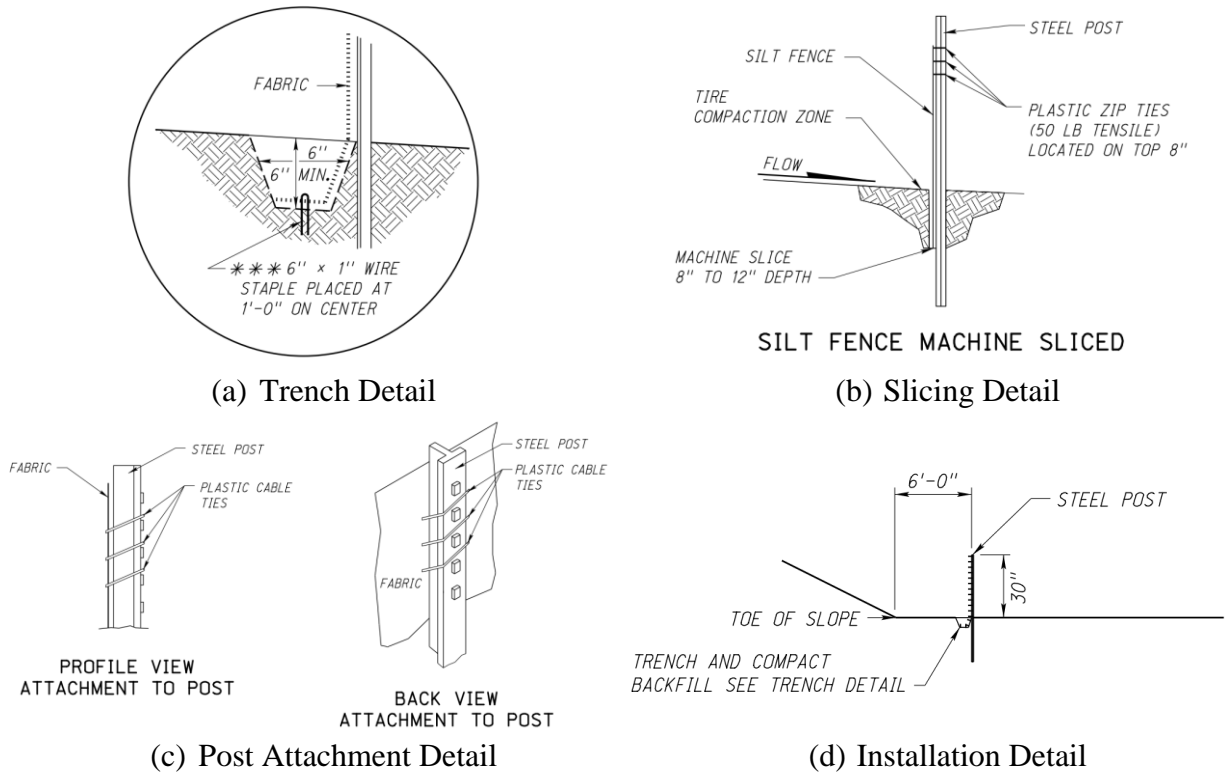


**Figure 3.1 Nebraska DOT Silt Fence Installation**

The conditions that silt fence installations are required to withstand can vary widely in different regions of the country; due to this, different jurisdictions have different standards. However, standards, especially for drainage areas for sections of silt fence, are often based on rules-of-thumb instead of site-specific conditions (Liu et al. 2021). Most drainage area guidance follows a maximum of a quarter acre for every 100 ft (a tenth hectare for every 30.5 m) of silt fence, with allowable drainage areas being larger for silt fences with reinforcement (Bugg et al. 2017a, Bugg et al. 2017b). Other guidance for silt fence design includes limiting the length and steepness of uninterrupted sloped upstream of silt fences, ensuring the installation can handle certain rainfall events (i.e., 10-yr, 2-yr, 24hr, etc.), and sheet flow volume (Bugg et al. 2017a).

The current Nebraska Department of Transportation standard silt fence installation is composed of a woven geotextile fabric attached to studded metal T-posts using three zip-ties at the top of the fabric. Fabric is trenched into a 6 in. (15.2 cm) deep by 6 in. (15.2 cm) wide trench and attached to the ground using staples before backfilling the trench to secure the fabric. Metal

t-posts must be at least 1.25 lb/ft (1.86 kg/m) and spaced at most 6 ft (1.82 m) apart (Nebraska Department of Transportation 2017). Figure 3.2 shows installation diagrams for the Nebraska DOT standard silt fence installation (Nebraska Department of Transportation 2021a).



**Figure 3.2 Nebraska DOT Silt Fence Installation Details**

### 3.2.3 Wattles

Wattles, fiber logs, or other tubular sediment barriers are often used for velocity reduction on slopes and in channels but can also be used as perimeter control. The installation is composed of a netting material and a fill material; however, both the netting and the fill material can vary, leading to varying hydraulic performance based on the fill and netting material (Whitman et al. 2021b). Figure 3.3 shows two applications of tubular sediment barriers on a highway construction project as ditch checks and slope protection.





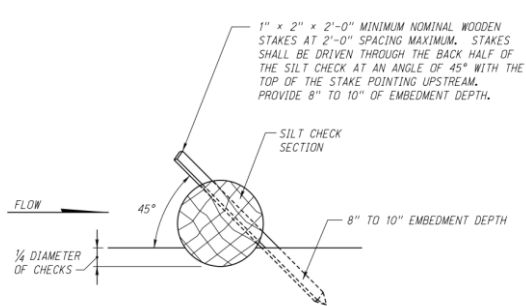
(a) wattle as slope protection



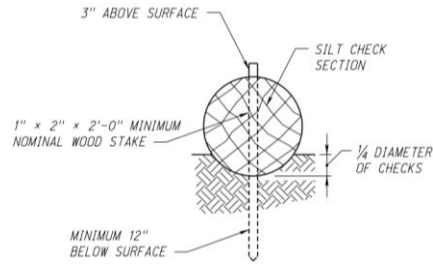
(b) wattles as ditch checks

**Figure 3.3 Wattle Installations on Nebraska Highway Construction Project**

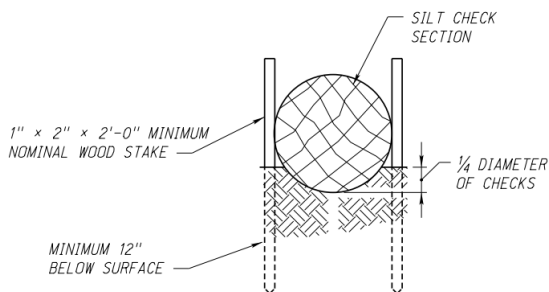
Installation techniques can vary widely, typically consisting of wooden stakes that run through the wattle or tented over it and sod staples to facilitate attachment to the ground surface. The current Nebraska Department of Transportation standard for installing wattles has four options, three of which require a trench of a quarter of the wattle's diameter. Three options also require a stake through the wattle, with the fourth having a stake on either side to hold the installation in place. Wattles are required to overlap with staggered joints. No stapling is required (Nebraska Department of Transportation 2021b). However, the installations shown in Figure 3.3 use stapling only to facilitate ground attachment. The fill material depends on the use; straw and excelsior fibers are the most common, with other natural and artificial materials also used (Nebraska Department of Transportation 2022). Figure 3.4 shows the standard details for tubular sediment barrier installations for the Nebraska DOT (Nebraska Department of Transportation 2021b).



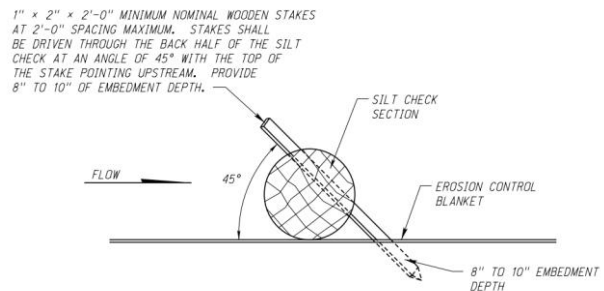
(a) option A for installation



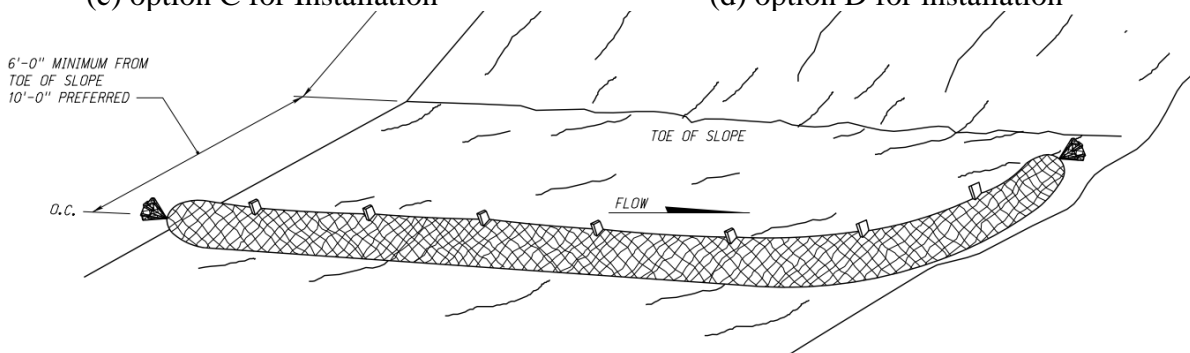
(b) option B for installation



(c) option C for installation



(d) option D for installation



(e) installation detail at toe of slope

**Figure 3.4 Nebraska DOT Tubular Sediment Barrier Installation Details**

### 3.2.4 Slash Mulch Berms

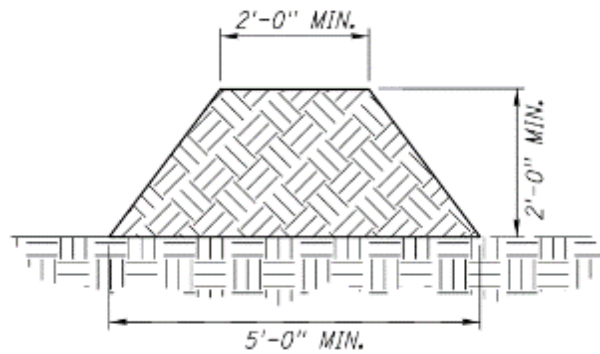
Slash mulch is a byproduct of land clearing, especially in areas where burning tree cover is not permitted, and is composed of shredded and chipped wood material. The material can be formed into triangular or trapezoidal berms that can be used as sediment barriers on the perimeter of sites. Some jurisdictions allow for the use of slash mulch berms as an alternative to silt fence sediment barriers (Nebraska Department of Transportation 2017). Figure 3.5 shows a

slash mulch berm installation on a construction project in Alabama and the sediment deposited upstream of the barrier.



**Figure 3.5 Slash Mulch Berm Installation** (photo courtesy of Cliff Young 2021)

The Nebraska Department of Transportation outlines slash mulch as an acceptable perimeter control on construction projects. A maximum height for berms is indicated as 36 in. (91 cm); berms must be at least 24 in. (61 cm) tall and 60 in. (152 cm) in width (Nebraska Department of Transportation 2021b). There are specifications for mulch material, with individual pieces not exceeding 20 in. (51 cm) in length or 2 in. (5.1 cm) in width after a visual inspection. After the project is completed, removing the slash mulch berms is not required like other installed sediment barriers; material can be either left in place or spread around the area (Nebraska Department of Transportation 2017). Figure 3.6 shows the standard cross-section drawing for Nebraska DOT slash mulch berms (Nebraska Department of Transportation 2021b).



**Figure 3.6 Nebraska DOT Slash Mulch Berm Standard Cross-Section**

### 3.2.5 Hay Bales

Hay and straw bales are another byproduct material created through various agricultural processes. These can be put together tightly as a sediment barrier for perimeter control by burying, staking in, and overlaying bales. However, most jurisdictions do not recommend using hay bales as a sediment barrier due to their numerous major limitations, including the rapid degradation of material that requires more intensive maintenance than other sediment barriers, the high likelihood of end-running and undercutting, the higher costs compared to other sediment barriers, and ineffectiveness at sediment capture. Even minor storms can degrade straw or hay bales to the point of reaching the sediment capacity of the barrier; more substantial storms can cause complete failure of the installation, causing little to no protection from pollution of downstream areas (USEPA 2021b). The Nebraska DOT, likely due to frequent structural failures, intensive maintenance, and overall lack of protection, does not outline hay or straw bales as an acceptable measure for sediment barriers.

### 3.2.6 Other Sediment Barriers

Other sediment barriers used on construction projects include sandbags, sediment retention barriers, floating turbidity barriers, and topsoil barriers.

Sandbags are composed of plastic geotextile bags filled with sand. In sediment control, sandbags are most commonly used as inlet protection practices or check dams in channels but can be used as a sediment barrier by stacking bags on top of each other across an area. Sandbags are typically installed across an even contour and have the ability to impound water behind installations (Hui 2010).

Sediment Retention barriers are a type of sediment barrier and are typically used as a secondary treatment to remove additional turbidity using chemical additives such as flocculant. Installations are composed of double rows of netting with jute or other material secured to the ground between netting. Loose straw with flocculant powder is added between the netting. Flow discharged from upstream sediment control practices passes through the installation; flocculant works to allow for the deposition of smaller soil particles as an additional treatment practice (Alabama Soil and Water Conservation Committee 2018; Whitman et al. 2019a).

Floating turbidity barriers are installed in bodies of water to protect waterways from turbid stormwater runoff. These barriers are composed of a geotextile curtain with weights on the bottom and floats on top to form a barrier within the waterway from sediment-laden runoff (Alabama Soil and Water Conservation Committee 2018)

Sediment barriers, when designed and installed correctly, serve the purpose of facilitating the deposition of sediment runoff before sediment is able to reach and harm waterways. Effectiveness can vary through installations and site conditions, such as sediment characteristics, location, and drainage area. Typically, barriers are designed to be temporary and removed after construction is completed (Alabama Soil and Water Conservation Committee 2018).

### **3.2.7 Field Monitoring of Sediment Barrier Installations**

Field monitoring of sediment barrier installations can provide insight into installation methods and the full-scale performance of sediment barrier methods. A review of silt fences on a roadway improvement project in Austin, Texas, was conducted by Barrett et al. to determine total suspended solids and turbidity treatment. During ten moderate to heavy stormwater runoff events, water samples were taken upstream and downstream of the silt fences to determine treatment and removal efficiency. Data was unable to be taken of storm events properties or in areas where structural deficiencies occurred, such as undermining, overtopping, or tearing. The median removal efficiency through the fence was 0%, ranging from -61% to 54%, with turbidity having a similar pattern. The lack of treatment was determined to be due to the large amount of smaller soil particles in the on-site soil being able to pass through the fabric. During the approximately five months of field monitoring, major installation and maintenance issues were apparent. Silt fence installations were damaged due to excessive impoundment and were not adequately repaired, leading to overtopping and flow bypassing the sediment barriers (Barrett et al. 1998).

Silt fence installations in the field often experience excessive sediment deposition and impoundment that exceeds capacity or is improperly installed on contours, leading to installation failures or flow bypassing installations altogether. To prevent excessive impoundment, long runs of silt fence and other sediment barriers can have tiebacks or J-hooks to increase storage volume and ensure that the installation can handle the runoff produced by a larger watershed. Zech et al. monitored two 300 ft (91 m) runs of silt fence, one having tiebacks and the other being a linear installation, over four naturally occurring storm events for sediment deposition and structural failures. The tieback system prevented erosion along the toe of the fence as flow moved down

the installation compared to the linear silt fence system. The additional detention areas also allowed additional sediment retention, even if a failure occurred. The occurrence of failure was reduced on the tieback installation compared to the linear silt fence system. Despite the improvements, the field monitoring indicated a need for maintenance to remove excess sediment and repair any deficiencies after storm events of sediment barrier installations with and without tiebacks to allow the installations to work as designed (Zech et al. 2009).

An Iowa Department of Transportation sponsored study monitored the ESC practices on a highway construction project in Tama County, Iowa, in July 2019. Runs of seven different types of silt fence installations were installed side-by-side to evaluate differences in performance between modified installations when exposed to similar stormwater runoff events. Structural performance, sedimentation, and the formation of impoundment were analyzed for all silt fence installations. Excessive post deflection leading to overtopping was found on numerous installations; modifications with reduced post spacing or added wire reinforcement did not have excessive post deflection. Figure 3.7 shows excessive sedimentation leading to excessive post deflection in the Iowa standard silt fence and not leading to excessive deflection in the modified installation with additional wire reinforcement. The authors of this study recommended either reducing post spacing or adding wire reinforcement to reduce the chance of structural failure from the standard Iowa DOT installation and adding a 6 in. (15.2 cm) offset trench to prevent undermining. However, the post spacing and wire reinforcement modifications did increase the cost of material and installation. Additionally, future research that tests modifications in a controlled environment to subject modifications and standards to identical conditions was suggested to work against the inconsistencies that are a limitation of field monitoring studies,



such as storm events and runoff differences for different installations of sediment barriers (Schussler et al. 2020).



(a) Iowa standard silt fence installation experiencing excessive post deflection



(b) Reinforcement preventing post deflection

**Figure 3.7 Iowa Sediment Barrier Field Monitoring** (Schussler et al. 2020)

Field monitoring allows for identifying structural deficiencies under real-world conditions and making conclusions about performance. Evaluations and monitoring discovered four common failure modes of silt fence installations: overtopping, undercutting, flow bypass, and excessive accumulation of material (Zech et al. 2009). A key takeaway of field monitoring is the identification of maintenance as a critical factor in the performance of a sediment barrier. Lack of consistent maintenance has been identified as a limitation of field monitoring, along with constantly shifting field conditions on sites and inconsistent stormwater runoff events (Barrett et al. 1998).

### **3.2.8 Small-Scale Sediment Barrier Testing**

Small-scale sediment barrier testing typically consists of material installed in a flume, either a geotextile fabric or other installable sediment barriers, such as wattles. Sediment-laden or clean water is passed through the material to determine performance qualities. Other material testing, such as post strength to determine spacing, can also be completed on a small-scale. However, small-scale testing can only determine the effectiveness of one aspect of sediment barrier installation, such as media or posts.

Wyant conducted some of the first sediment barrier testing and aimed to determine the filtration efficiency of 15 different silt fence fabrics by introducing the three dominant soil types of Virginia into an 8% slope flume with fabric at the end. The primary finding of this research was that an impoundment was created in the flume by the fabric, causing sediment to be able to settle out of suspension, especially when compared to the common sediment barrier practice of the time of straw bales. The dam-like effect of the fabric led to a sediment removal efficiency of 92% for silty soil and 97% for sandy soil (Wyant 1980). Flume testing led to the development of

the ASTM D5141 Standard Method for Determining Filtering Efficiency and Flow Rate of the Filtration Component of a Sediment Retention Device.

The ASTM D5141 Standard Method for Determining Filtering Efficiency and Flow Rate of the Filtration Component of a Sediment Retention Device was developed to allow for the standard testing of different geotextile silt fence fabrics through determining the flow rate through the fabric. Flow composed of 13.3 gal (50 L) of water mixed with 0.33 lb (0.15 kg) of soil is introduced into a flume with a 3.3 ft by 1 ft (1 m by 0.3 m) sample of geotextile. The amount of water remaining behind the sample is recorded after 25 minutes to determine the flow rate through the fabric. Samples are taken downstream that are tested for suspended solids to determine the filtering efficiency of the fabric (ASTM 2018a).

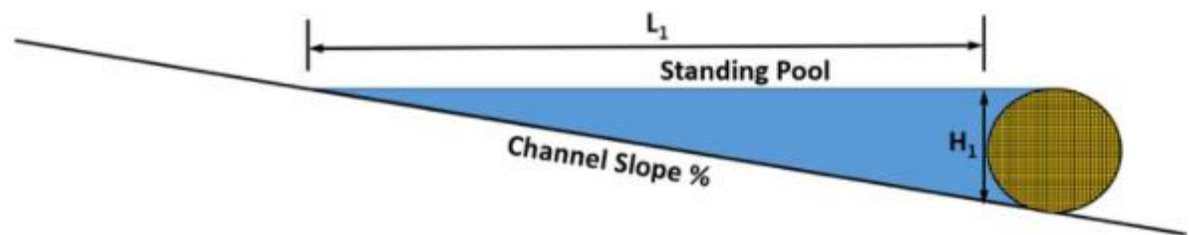
Another set of testing of sediment-laden stormwater treatment occurring through geotextile fabric aimed to determine the method of treatment by the geotextile fabric by evaluating detention time, permittivity, and flow on total suspended solids (TSS) reduction. A major finding of this testing was a direct correlation between the sediment removal efficiency of fabrics tested and water detention time behind the fabric. The relationship between sediment removal efficiency and permittivity was not strong. The fabric with the highest reported permittivity produced the highest sediment removal and the longest detention time due to having the smallest apparent opening size, which was then clogged with sediment. The strength of the relationship between detention time and sediment removal and the lack of the relationship between permittivity suggests that the sediment removal was due to sedimentation within the impoundment formed. Woven and non-woven geotextile fabrics were tested with both fabrics trapping sediment, causing openings to clog; however, the non-woven fabric retained more sediment, and sediment was less easily removed from the fabric (Barrett et al. 1998). Another set

of flume testing on geotextiles found that the flow through the fabric decreased through the duration of the test as openings became clogged with sediment. Smaller particles were not able to be removed through the process of sedimentation. The primary finding of the second part of this testing was that maintenance was required for a silt fence to work appropriately. Sediment should never reach more than half of the height of the fence, and fabric would need to be treated to remove sediment buildup on it prevent flow through (Henry and Hunnewell 1995).

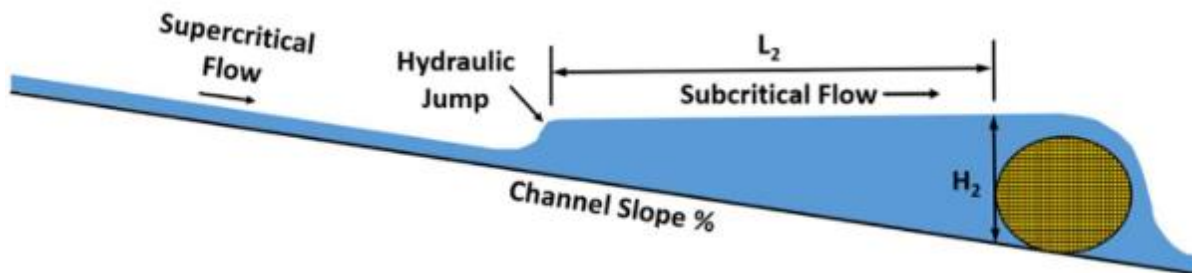
Testing conducted at the AU-SRF aimed to improve the standards of small-scale testing. Instead of flow being introduced into a flume of a constant slope, the flow of sediment-laden stormwater runoff equivalent to the peak 30 minutes of the 2-yr, 24-hr storm local to Alabama was introduced into a flume that mimicked more realistic runoff conditions. The flume had a 33% slope that leads into a relatively flat area with 1% slope before sheet flow runs into the installed geotextile fabric. Data collected during testing included water quality samples, water depths, and sediment retained. Water samples were taken upstream of the fabric at the top and bottom of the impoundment and at the discharge point to determine treatment efficiency. Water depths were used to determine the facilitation of impoundment and flow-through-rates. Data was collected during a 30-min introduction period and a 90-min dewatering period. Non-woven and woven geotextiles were tested, with non-woven having higher sediment retention rates on average (97% and 98%) than the woven geotextiles (94%, 93%, and 87%). Water quality data was used to determine the filtration efficiency, which was found to be less of a factor than the sedimentation efficiency, especially during the test period, where the filtration efficiency showed an increase in total suspended solids (Whitman et al. 2019b). The same testing apparatus and a similar methodology were used to evaluate double-rowed sediment barriers; through testing an identical upstream practice of a geotextile and various downstream barrier installations, such as

different nettings and fills of wattles. Turbidity reduction was the key factor analyzed, and water quality samples were taken upstream of the primary barrier, the bottom of the impoundment behind the primary barrier, between the two barriers, and downstream of the secondary barrier to determine treatment through both barriers and the entire system. All the tested tubular secondary sediment barrier systems showed improvement over the base condition of two geotextile installations. However, this testing also showed that much of the cross-sections of the tubular secondary sediment barrier controls were unused during testing, showing potential for improvement in the design of secondary tubular sediment barriers (Whitman 2022).

Other sediment barriers, especially wattles, have been evaluated through small-scale flume testing. A flume at Iowa State University was used to test wattles of various containment mesh (e.g., Natural Netting, Polyester Socks, HDPE netting, and HDPE socks) and fill media (e.g., excelsior fibers, wheat straw, standard and premium coconut coir, wood chips, synthetic fiber, and miscanthus fiber) on the impoundment length and depth formed behind the practice under clean-water conditions. Shown in Figure 3.8, a hypothetical impoundment depth and length of the height of the wattle and a flat standing pool were compared to the actual results for each practice to allow for the adjustments of installations to better fit actual conditions, such as variations in slope. Excelsior wattle materials were found to be less effective in creating impoundment and facilitating subcritical flows; wattles composed of wheat straw were slightly more effective. The most effective wattles tested were miscanthus filled, facilitating an actual impoundment length and depth of only around 10% less than the theoretical conditions. This testing showed a wide range in performance through different wattle materials (Whitman et al. 2021b).



(a) Theoretical impoundment depth and length



(b) Measured impoundment depth and length

**Figure 3.8 Theoretical and Measured Impoundment formed by tested wattles** (Whitman et al. 2021b)

Another set of wattle testing aimed to analyze the effect of encasement materials on hydraulic conditions. Twenty different encasement materials with different apparent opening sizes were tested under identical flow conditions in a flume to determine the impoundment depth and length created solely by the encasement material. Testing found that, on average, decreasing the percent open area led to an increased impoundment depth and length. Encasement materials composed of cotton fabrics performed better than polyester and polyester-polypropylene fabrics despite the latter having smaller opening sizes. However, lowering flow conditions caused differing results, and only clean water flow was introduced; different results could occur with the sediment-laden flow installations will experience when installed on construction projects (Clampitt et al. 2023).

The structural load capabilities of silt fence posts can be evaluated and used to determine optimal post spacing under fully loaded conditions. Whitman et al. determined the maximum

moment post specimens can experience before failure under three-point loading. This maximum moment can be used to determine the hydrostatic loading an installation's posts can withstand before failure. A recommended post spacing was calculated from the maximum hydrostatic loading over the tributary area; this spacing ensures structural stability under excessive impoundment events. Metal T-posts were found to have varying recommended post spacing for each size, while hardwood posts had a consistent recommended spacing. Metal posts of 0.95, 1.25, and 1.33 lb/ft (1.4, 1.9, and 2.0 kg/m) had recommended spacing of 3.94, 5.91, and 7.87 ft (1.2, 1.8, and 2.4 m), respectively. Hardwood posts had a recommended spacing of 4.92 ft (1.5 m) (Whitman et al. 2021a).

Small-scale sediment barrier testing provides insight into the sediment trapping and performance of sediment barriers, such as determining that the formation of impoundment and the facilitation of sediment falling out of suspension is more pertinent to sediment-laden stormwater treatment than filtration through geotextile fabrics. However, flume testing fails to examine the performance of the installation, such as ground contact, structural performance, and maintenance. Testing on posts helps shed light on the structural performance of silt fence sediment barriers; however, it also fails to consider maintenance and the complete characteristics of sediment barrier installations.

### **3.2.9 Large-Scale Sediment Barrier Testing**

Large-scale sediment barrier testing attempts to improve upon the limitations of both small-scale and field testing by testing entire sediment barrier installations in a completely controlled environment. Pertinent factors, such as impoundment formed, structural performance, and sediment retention, can be tested for the entire installation and not solely certain aspects.

One large-scale sediment barrier testing method employs a lifted test bed subjected to rainfall simulation to subject the sediment barrier to sediment-laden stormwater runoff conditions. Gogo-Abite and Chopra used this method on bare sandy soil slopes of 10%, 25%, and 33% under three simulated rainfall intensities of 1, 3, and 5 in./hr (25.4, 76.44, and 127 mm/hr) to test a woven and a non-woven silt fence installation. Water quality samples were taken at regular intervals upstream and downstream of the installations to determine sediment removal efficiency. Structural performance, such as the ability of the installation to resist overtopping, tearing, and other failures that could cause uncontrolled sediment-laden discharge, was also investigated. The woven and non-woven silt fence installations were compared, with the non-woven fabric being more efficient at reducing turbidity at 52% reduction compared to the 18% reduction of the woven fabric; the conclusion was made that the increased performance of the non-woven fabric was due to the smaller average opening size than the woven fabric. Neither fabric was able to reach reduction standards in turbidity or sediment concentration. The testing found that when the test bed had a steeper slope, more structural performance issues, such as overtopping, occurred due to the additional sediment load experienced by the installation (Gogo-Abite and Chopra 2013). Testing of sediment barriers using sediment-laden flow produced by rainfall simulation often does not facilitate field conditions, as the contributing areas for silt fences under most standards are far larger than the slopes used in testing.

Another method of testing large-scale installations of sediment barriers under controlled settings, outlined by Kincl et al., uses a calibrated overflow flume to send flow through an earthen area into an installed sediment barrier. This testing used two different flow rates, 0.18 and 0.35 ft<sup>3</sup>/s (5 and 10 L/s), for 25 minutes across a 20 ft (6 m) area of soil into three different sediment barriers: silt fences, straw bales, and a soil bund with vegetation. Sediment capture was

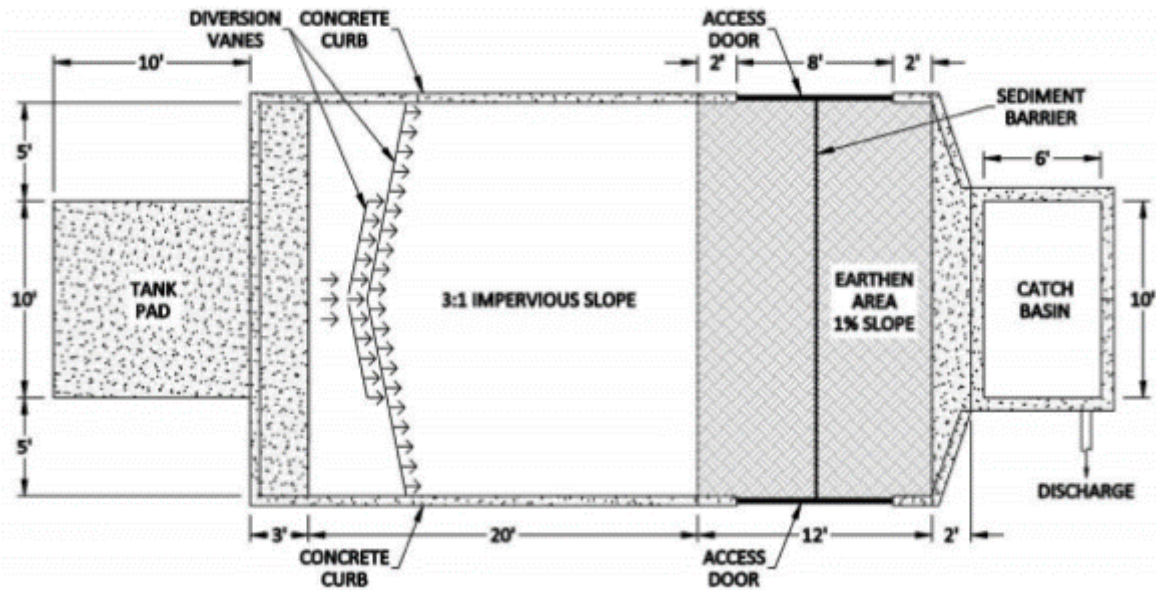


the key data collected during this testing and was measured using 3D laser scanning of the surface before and after flow introduction. Testing found a similar average of capture, at about 90% of sediment, across the three barriers. There was a degradation of performance during the testing of the straw bales, showing a need for increased maintenance of these barriers. Due to flow bypassing barriers after large amounts of sediment deposition at the barrier, this testing concluded that maintenance is a key performance indicator and needs to be considered in the overall efficiency of a sediment barrier (Kincl et al. 2022).

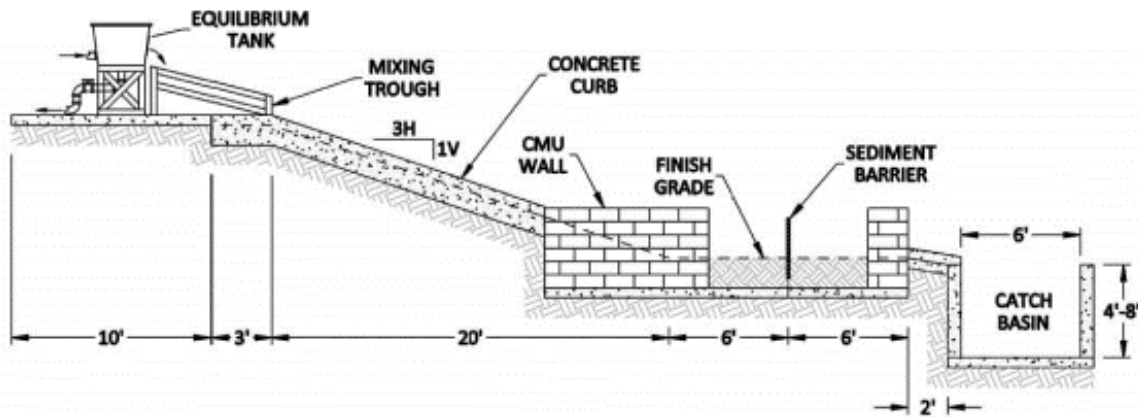
Another commonly used large-scale sediment barrier testing method is the ASTM 7351M-21 Standard Test Method for Determination of Sediment Retention Device Effectiveness in Sheet Flow Applications. ASTM 7351M-21 outlines a method that tests sediment barrier installations by introducing sediment-laden sheet flow down a 3:1 (H:V) slope running into an earthen installation area that is approximately 20 ft (6 m) by 6.6 ft (2 m) with a sediment barrier installed. Sediment load and flow are constant across testing using this method with a total of 4,700 lb (2,140 kg) of water mixed with 300 lb (140 kg) of dry soil over the test period. However, there is an option within this standard of calculating flow rates based on conditions local to different regions using the Modified Universal Soil Loss Equation (MUSLE). Flow rates are calculated from the peak 30 minutes of a 10-yr, 6-hr storm and a contributing slope of 100 ft (30 m) by 20 ft (6 m). Data collected in testing under this standard include grab samples of water taken at 5-minute intervals from the mixing tank and downstream of the barrier to be tested for turbidity and total suspended solids concentration and sediment passing through the barrier (ASTM 2021).

To improve upon the existing ASTM standards for sediment barrier testing, Bugg et al. created a large-scale sediment barrier testing apparatus at the AU-SRF that can simulate a worst-

case stormwater runoff event. A calibrated flow of water and sediment is introduced at the top of a 3:1 (H:V) impervious slope that spreads flow using diversion lanes into sheet flow. Flow runs into a 20 ft (6.1 m) wide earthen area with a sediment barrier installed. Figure 3.9 shows a schematic of the testing apparatus. Flow and sediment introduction is able to be calibrated based on the runoff produced by the peak 30 minutes of a local 2-yr, 24-hr storm for a representative drainage area, which is based on standards in place for tested barriers. Each tested installation was subjected to three back-to-back simulated runoff events to show longevity effects (Bugg et al. 2017a). The Alabama Department of Transportation (ALDOT) non-woven silt fence standard installation was tested using this apparatus. Water quality, sediment retention, and structural performance were analyzed and used to propose modifications that were then evaluated using the same method. Modifications tested included increased T-post weight, decreased spacing, decreased fence height, and an offset trench. All modifications aimed to decrease the possibility of structural failures such as overtopping, undermining, and excessive post deflection. Modifications were shown through a multiple linear regression model to show improvement in post deflection. Installations with structural failure showed considerable variation in performance. Installations that did not overtop retained 95% of sediment upstream, while installations that overtopped retained 83% (Whitman et al. 2019a).



(a) plan view



(b) profile view

**Figure 3.9 Schematic of Testing apparatus used by Bugg et al. and Whitman et al. (Whitman et al. 2018b)**

Manufactured sediment barrier products (i.e., straw wattles, compost logs, and excelsior blocks) were tested with the same method and were found to have less average impoundment than silt fence sediment barriers, leading to less sediment capture. Tubular products, such as trenched straw wattles and compost logs, were subjected to undermining, which led to decreased performance. Impoundment greater than 1 ft (0.3 m) facilitated sediment capture of over 90%; sediment capture does not improve with increased impoundment over 1.5 ft (0.46 m) in depth.

Testing found that barriers, such as innovative and manufactured products, that cannot impound substantial runoff will have less sedimentation in the impoundment formed. A modified sediment retention barrier (SRB) that consists of flocculant-laden wheat straw installed on top of jute and held in place by reinforcing wire and posts was tested using this method. The SRB was tested with and without flocculant, with the flocculant-laden installation capturing 83% of sediment compared to the 63% of the non-flocculant laden installation while also having a lower flow-through-rate (Whitman et al. 2019a).

Large-scale testing at the AU-SRF indicated that excessive impoundment due to the clogging of geotextile pores not allowing for effective dewatering could cause structural performance issues and potentially lead to the failure of the installation. A dewatering board with a V-notch overflow weir and four holes located every 3 in. (7.6 cm) was designed to allow for the slow dewatering of the installation after a storm event. An overflow weir was placed at 18 in. (45.7 cm) to serve as an emergency spillway during major storm events to protect the installation of uncontrolled overtopping. The 18 in. (45.7 cm) height of impoundment was found during past testing to be the point at which little additional benefit in sediment removal occurred. An energy dissipating device, consisting of riprap over a geotextile, was installed directly downstream of the dewatering board to protect from scour due to flow coming through the weir and dewatering holes. A control installation of a wire-backed trenched non-woven silt fence installation that was found to be the most feasible and effective installation during past testing was compared to an identical installation with the dewatering board installed under repeated 2-yr, 24-hr storm runoff conditions and analyzed for sediment retention, water quality, and effluent flow rates. The installations with the dewatering board dewatered fully in 4 hours with little disturbance of downstream areas due to the energy dissipation device; the control installation took over 24

hours to dewater fully. There was no loss in sediment retention performance experienced due to the installation of the dewatering board; installations retained an average of 96% of introduced sediment during the three back-to-back stormwater runoff events. Similar downstream turbidity results were shown in the installations with the dewatering board and the control installations, as well as matching the results of past testing using the same methodology. The results of this testing indicate that installing a dewatering board in an area that will experience high levels of impoundment during storm events can be effective in protecting silt fence installations from the structural deficiencies associated with large amounts of impoundment over time and downstream areas from uncontrolled discharge due to failure or overtopping (Whitman et al. 2021a).

### **3.3 Sediment Barrier Testing Methodology**

Sediment barriers, including silt fences, slash mulch berms, and wattles, were evaluated using the testing apparatus and method outlined in Bugg et al. (Bugg et al. 2017a). For tests conducted on Nebraska DOT standard sediment barriers, the testing methodology was adjusted to simulate conditions local to Nebraska highway construction projects. Development of the testing methodology took place in four stages: (1) determining flow and sediment introduction conditions using statewide average hydrological and soil loss conditions, (2) selecting water quality grab sample locations, (3) adjusting the sediment retention calculation method, and (4) choosing installations and materials to test, which was an ongoing process as testing occurred, observations were made, and modifications to improve structural performance were found.

#### **3.3.1 Runoff Analysis for Nebraska Testing**

To determine flow and sediment introduction rates used in testing, a representative area was developed based on the drainage area guidance of 0.5 ac (0.2 ha) per 100 ft (30.5 m) of sediment barrier, a design criterion used for silt fence in some jurisdictions and used to test

sediment barriers in the same testing apparatus (Bugg et al. 2017b). The AU-SRF sediment barrier testing apparatus has a 20 ft (6.1 m) wide test bed, resulting in a representative drainage area of 0.1 ac (0.04 ha) for all testing that occurred.

### 3.3.1.1 Flow Rate Determination

Conditions used in testing are those produced by the peak 30-min of the local 2-yr, 24-hr storm event, the often-used design storm for developing sediment barrier standards. To determine the amount of runoff produced by the design storm, the TR-55 Urban Hydrology for Small Watershed design approach was used. The combination of two equations (eq. 2-3 and eq 2-4 in the TR-55 Manual) resulted in Eq. 3.1, which can be used to calculate the runoff depth for an area.

$$Q = \frac{\left(P - \frac{200}{CN} + 2\right)^2}{P + \frac{800}{CN} - 8} \quad \text{Eq. (3.1)}$$

where,

$Q$  = runoff depth (in.)

$P$  = rainfall depth (in.)

$CN$  = curve number

The runoff depth represents the average amount of runoff produced by the analyzed design storm. Rainfall depth is the amount of rainfall produced by the design storm. Using GIS data from the National Oceanic and Atmospheric Administration Atlas 14 data, the average rainfall depth across Nebraska for the 2-yr, 24-hr storm was determined. Figure 3.10a shows the average rainfall depth contours across the state of Nebraska. The Curve Number (CN) represents the infiltration characteristics of an area and is a function of the amount of impervious area and the

soil classification; average CN was calculated by determining the amount of soil an area has in each of the four hydrological groups (A, B, C, D) by using Eq. 3.2. A map of the weighted average CN across the state of Nebraska is shown in Figure 3.10b.

$$CN = a * 77 + b * 86 + c * 91 + d * 94 \tag{Eq. (3.2)}$$

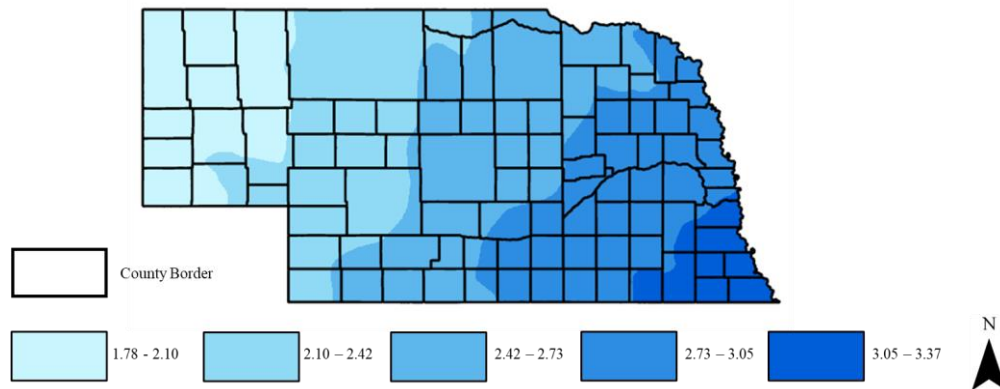
where,

$a$  = percentage of group A soil

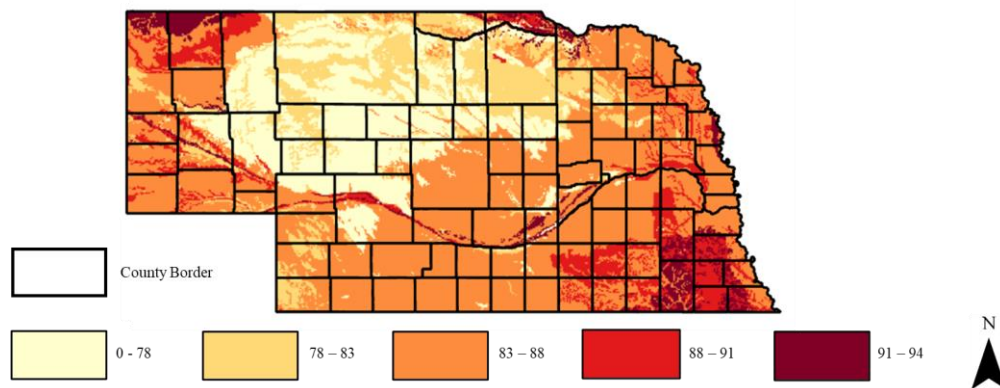
$b$  = percentage of group B soil

$c$  = percentage of group C soil

$d$  = percentage of group D soil



(a) rainfall depth (in.) across Nebraska



(b) weighted average curve number raster across Nebraska

**Figure 3.10 Hydrological Conditions of Nebraska**

From the hydrological analysis of the state of Nebraska, the values were obtained for CN, 83.76, and rainfall depth, 2.34 in. (5.94 cm), which resulted in a runoff depth of 0.977 in. (2.48 cm) from Eq. 3.2. Runoff values, area, and flow length and slope for the representative drainage area were entered into AutoCAD Civil3D to create a hydrograph for the design storm across the drainage area. Values for the time of concentration, average flow, and peak flow for the design storm were found using the hydrograph. The average flow for the peak 30-min of the 2-yr, 24-hr storm was 0.086 ft<sup>3</sup>/s (0.0024 m<sup>3</sup>/s) and was the flow rate used across Nebraska DOT testing. A peak flow of 0.183 ft<sup>3</sup>/s (0.0051 m<sup>3</sup>/s) was used in soil loss analysis.

### 3.3.1.2 Sediment Introduction Rate Determination

To determine the sediment runoff caused by the flow from the 2-yr, 24-hr storm, the Modified Universal Soil Loss Equation (MUSLE) was used, which uses numerous site-specific conditions to calculate the estimated soil loss from the rainfall and runoff energy from a storm, shown in Eq. 3.3.

$$S = 95(QP_p)^{0.56}KLSCP \quad \text{Eq. (3.3)}$$

where,

$S$  = sediment yield (tons)

$Q$  = runoff volume (acre-ft)

$P_p$  = event peak discharge (ft<sup>3</sup>/s)

$K$  = soil erodibility factor

$LS$  = slope-length and steepness factor

$C$  = cover factor

$P$  = practice factor



The runoff volume and peak discharge were found using the hydrograph created for determining testing flow rates. The soil erodibility factor was determined using GIS analysis of the state of Nebraska that created a soil erodibility raster and then averaged the soil erodibility across the state, which was 0.25. The slope-length and steepness factor was determined by taking a weighted average slope-length factor across the representative drainage area and the test apparatus; a flow length of 218.9 ft (66.7 m) with a slope-length and steepness factor of 1.04 was used for soil loss analysis. Cover and practice factors of 1.0 were used, representing that the representative slope did not have any erosion or sediment control practices installed to prevent erosion or sediment-laden runoff. The runoff volume, peak discharge, and all other factors were inputted into the MUSLE, which resulted in a total soil loss of 0.399 tons (0.363 metric tonnes) or 797.9 lbs (361.2 kg) across the peak 30-min of the average Nebraska 2-yr, 24-hr storm across the representative drainage area. To determine the sediment introduction rate, the total soil loss was divided by the 30-min test period and resulted in 26.6 lb/min (12.1 kg/min).

### **3.3.2 Experimental Design**

The following section outlines the testing methodology, including the testing apparatus, plot preparation, data collection methods, and the testing regime to determine the most feasible and effective sediment barrier installations. Primarily, the testing methodology outlined by Bugg et al. was used; however, adjustments were made, including lining the test bed with plastic sheeting and installing slash mulch berm and wattle installations at the downstream end of the apparatus to allow for collection of deposited upstream sediment and sediment in the catch basin at the downstream end of the testing apparatus (Bugg et al. 2017a). Additionally, the water level in the catch basin was monitored to determine the flow-through rates of each sediment barrier.

### 3.3.2.1 Testing Apparatus

The testing apparatus, shown in Figure 3.9 used across all testing is the same developed by Bugg et al. and used in numerous research efforts on sediment barriers (Bugg et al. 2017a, Bugg et al. 2017b, Whitman et al. 2018, 2019, 2021). Water was pumped from a nearby supply pond to a 300 gal (1,135 L) tank with a calibrated weir, a water pressure tube, and a system of outflow valves that allow for the calibration and monitoring of flow rates. Flow then passes through the calibrated weir into a mixing trough that induces turbulent flow to mix with introduced soil. Before testing, native soil from an on-site stockpile at the AU-SRF was run through a mechanical shaker to remove debris and measured into 60 buckets with 13.3 lb (6.0 kg) of soil in each; buckets were dumped into the mixing trough to introduce to flow at a rate of 30 seconds per bucket. The now sediment-laden flow runs out of the mixing trough and down a 3H:1V impervious metal slope with diversion lanes that induce sheet flow.

Flow passes down the slope into a 12 ft (3.7 m) long by 20 ft (6.1 m) wide test bed composed of native soil. The test bed was prepared between tested installations by removing approximately the top 2 ft (0.61 m) of wet soil and replacing the area with two lifts of dry soil. Each lift was leveled and compacted using an upright jumping-jack compactor to compact each to 95% of the maximum dry density. After preparation, the test bed was leveled perpendicular to flow and graded at 1% slope in the direction of flow to ensure flow travels from the slope, across the test bed, and through the barrier. Barriers were installed in the test bed at different locations depending on the barrier; silt fences were installed in the center of the test bed, slash mulch berms were installed with the back toe of the berm at the end of the test bed, and wattles were installed 10 ft (3.0 m) from the toe of the slope as shown in the Nebraska DOT standards (Nebraska Department of Transportation 2021b). The test bed up until the front face of the

sediment barriers was lined with plastic sheeting to allow for the removal and measurement of deposited soil upstream; for slash mulch berm installations, the entire test bed was lined with plastic sheeting.

After flow passed across the test bed and through the sediment barrier, it entered a collection catch basin. Water depth in the catch basin during testing was monitored using a Solinst Leveloger that took water pressure measurements at 15-second intervals to calculate water depth within the catch basin; flow-through-rates of sediment barriers were calculated using the difference in water level in the catch basin between 15-second intervals. For sediment barriers that were not linear, such as wattles or slash mulch berms, the sediment-laden water that was collected in the catch basin was dosed with flocculant that had been previously matched with the native AU-SRF soil to allow for the sediment that had passed through the barriers to more quickly settle out of suspension within the catch basin. Water was then pumped out of the basin with samples taken of the discarded water to determine the amount of sediment still suspended, and the sediment remaining in the catch basin was removed and measured to determine the amount of introduced sediment that could pass through the barriers. For all silt fence installations, the water level in the catch basin was still monitored to determine flow-through rates but was discharged between tests.

### **3.3.2.2 Sampling and Measurements**

During testing, water quality grab samples were taken at 5-min intervals through the 30-min sediment-laden flow introduction period (timestamp of 5, 10, 15, 20, 25, and 30 min) and at 5-, 10-, 15-, 30, 60-, and 90-min (timestamp of 35, 40, 45, 60, 90, and 120 min) after the stoppage of flow to continuously monitor water quality throughout the testing and dewatering periods. Samples were taken in 8 oz (250 mL) sample bottles; samples were tested for turbidity

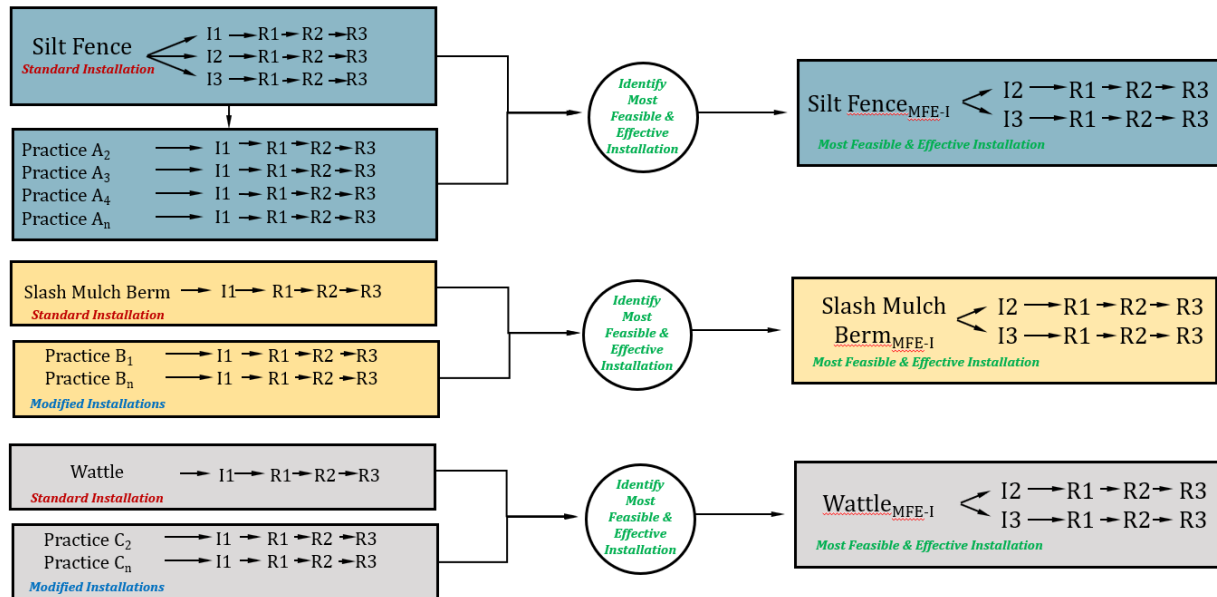
using a Hach TL2300 turbidity meter and for TSS according to ASTM standards (ASTM 2018b; c).

The depth and length of the impoundment formed behind each sediment barrier were measured at the same intervals as the water quality samples. Impoundment length was measured using a tape measure installed on the edge of the test bed, with the start of the measure being at the front face of the barrier. Impoundment depth was measured using a ruler at the front face of each sediment barrier practice.

### **3.3.2.3 Testing Regime**

To meet the research objectives of determining the effectiveness of standard Nebraska DOT sediment barriers and recommending the most feasible and effective installations (MFE-I), a testing regime of standard and modified sediment barrier installations was developed, shown in Figure 3.11. Standard installations (three for silt fence and one each for slash mulch berms and wattles) were tested under three back-to-back simulated stormwater runoff events. Additionally, for each new installation, an excessive impoundment condition was run after deposited sediment was removed, representing an extreme-case stormwater runoff event to determine performance under excessive impoundment conditions. For the extreme-case stormwater runoff event, the maximum flow rate of clean water the apparatus was able to supply was run, approximately 0.20 ft<sup>3</sup>/s (0.006 m<sup>3</sup>/s); flow was run until either a failure occurred, such as overtopping or complete failure, or the installation reached a steady-state condition where impoundment no longer was rising. Results from the testing of standard installations were used to develop modified installations that aimed to improve upon structural inefficiencies shown while also aiming to improve sediment retention and water quality improvements. After testing of modifications, the

MFE-I was selected that considers performance, installation difficulty and cost; testing of the MFE-I was triplicated to generate more data for recommendations.



**Figure 3.11 Sediment Barrier Testing Regime**

### 3.3.3 Materials for Testing

Allocated testing materials were chosen from the Nebraska DOT approved products list, standard plans and standard specifications. Materials for silt fence testing were according to the Nebraska DOT standard plans, standard specifications, and approved products lists (Nebraska Department of Transportation 2017, 2021a, 2022). Materials used for testing of standard Nebraska DOT silt fences and certain modifications include a 36-in. roll of polypropylene filament woven silt fence fabric, 6 ft (1.8 m) 1.25 lb/ft (1.86 kg/m) studded T-posts, 50-lb (22 kg) tensile strength black UV-stabilized zip-ties, and 6 in. (15.2 cm) sod staples. Other silt fence fabrics were also tested, including a Georgia DOT Type C woven fabric with polypropylene backing and a high porosity silt fence fabric. The same t-posts, zip-ties, and sod staples were used throughout all silt fence modifications tested.

Straw and excelsior wattles from the Nebraska DOT approved products list were allocated for testing. Wattles on the approved products list are classified as silt checks; 12 in. (30.5 cm) straw wattles are listed under Type 1-high, while 12 in. (30.5 cm) excelsior wattles are listed under Type 2-high, which includes all wood-based wattles. Staples for securing wattles are the same 6 in. (15.2 cm) sod staples used in silt fence testing. In accordance with the Nebraska DOT special plans, 1 in. (2.5 cm) by 2 in. (5.0 cm) by 2 ft (0.61 m) nominal stakes were used to install wattles.

Slash mulch was sourced locally from construction projects with land-clearing activities in central Alabama. Material was visually investigated to ensure it met the Nebraska DOT material standards of a maximum length of 20 in. (51 cm) and a maximum width of 2 in. (5.1 cm).

### **3.4 Sediment Barrier Testing Results**

The results of sediment barrier testing are divided into three main performance categories: structural performance, water quality, and sediment retention. Each of the three types of sediment barrier installations (e.g., silt fence, slash mulch berms, and wattles) varied widely across performance indicators of all three performance categories.

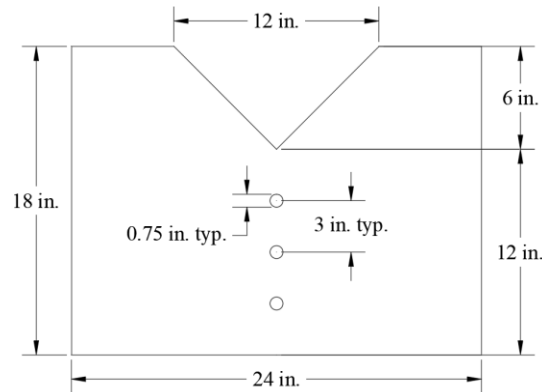
#### **3.4.1 Silt Fence Results**

Three installations of the Nebraska DOT standard silt fence, five modified installations, and a high porosity silt fence were tested. Each modification aimed to improve on structural performance inefficiencies experienced by either the standard installations or previous modifications. Tested installations are described below:

- Standard Nebraska DOT Installation (STD): standard used on Nebraska highway construction projects, with woven fabric, 6 ft (1.8 m) 1.25 lb/ft (1.86 kg/m) studded steel T-posts spaced 6 ft (1.8 m) apart, fabric entrenched 6 in. by 6 in. (15.2 cm by 15.2 cm) at

the base of the posts and attached to the posts with three 50 lb (22 kg) tensile strength black, UV stabilized zip-ties at the top of the fabric.

- Modification 1 (M1): identical to the standard installation with T-posts offset 6 in. (15.2 cm) downstream of the trench.
- Modification 2 (M2): identical to Modification 1, with steel T-posts replaced with 2 in. by 2 in. (5.1 cm by 5.1 cm) wooden posts attached to the fabric using staples along the height of the post.
- Modification 3 (M3): identical to Modification 1, with the woven silt fence fabric replaced with a woven fabric with a built-in polypropylene mesh backing. The fabric fits the Georgia DOT Type C Alternative silt fence fabric standard.
- Modification 4 (M4): identical to Modification 1, with a plywood dewatering board with an overflow weir installed at the center of the installation and a scour-preventing splash pad of an excelsior wattle and blanket installed directly behind the dewatering board. The dewatering board was constructed of a 0.75 in. (1.91 cm) thick, 18 in. (45.7 cm), and 24 in. (61 cm) sheet of plywood. A 6 in. (15.2 cm) deep V-notched overflow weir was cut at a 90-degree angle at 12 in. (30.5 cm) above grade; three 0.75 in. (1.91 cm) diameter dewatering orifices were spaced at 3 in. (7.6 cm) apart beneath the overflow weir. The dewatering board is attached to two posts directly on each side with the same zip-ties used across installations. Figure 3.12 shows a diagram of the dewatering board.



**Figure 3.12 Dewatering Board with Overflow Weir**

*Note: 1 in. = 2.54 cm*

- Modification 5 (M5): identical to Modification 4, with post spacing adjusted from 6 ft (1.8 m) to 4 ft (1.2 m).
- High Porosity Silt Fence (HP): identical to the Nebraska DOT standard, with the woven fabric replaced with a high porosity silt fence fabric.

### 3.4.1.1 Structural Performance of Silt Fence

The standard Nebraska DOT silt fence installation experienced multiple structural inefficiencies after being subjected to three installations of three back-to-back simulated stormwater runoff events. Undercutting and a complete trench failure were experienced, as shown in Figure 3.13. Excessive impoundment conditions leading to complete failure and overtopping were unable to be experienced under the 2-yr, 24-hr storm conditions used in the three back-to-back simulated stormwater runoff events; however, under excessive impoundment conditions, once impoundment behind the installation reached approximately 20 in. (51 cm), due to excessive sagging, the zip-ties tore through the fabric leading to fabric separating from the posts and the installation completely failing. Figure 3.13 shows the structural performance issues shown through testing the Nebraska DOT standard installations.

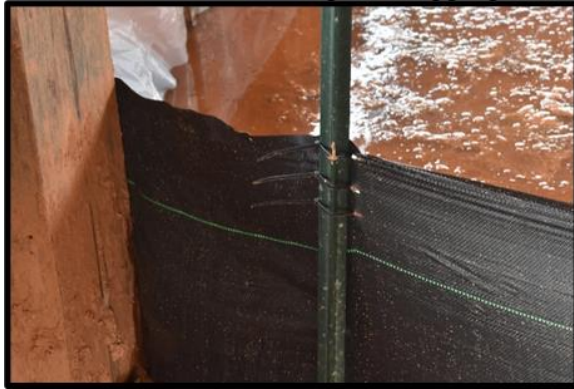




(a) undermining and sagging



(b) trench failure



(c) stretching of fabric around zip-ties



(d) complete installation failure due to excessive impoundment conditions

**Figure 3.13 Structural Performance Inefficiencies Experienced by Nebraska DOT Standard Silt Fence Installations**

To improve upon the structural inefficiencies experienced by the standard installation, M1 was developed with a 6 in. (15.2 cm) offset trench included, with the T-posts moved downstream from the trench. The offset trench had the goal of more consistent and reliable compaction of the trench, shown in prior testing on Alabama DOT silt fence installations, which prevents undermining and complete failure of the trench. The same results were shown through testing under Nebraska conditions: undermining or complete trench failure was not indicated, and there was less observed flow passing underneath the installation. An additional benefit of the offset trench was reducing the height of the installation from 24 in. (61 cm) to 18 in. (46 cm) to prevent catastrophic installation failure at excessive impoundment conditions; impoundment under standard conditions never exceeded 13 in. (33 cm) in depth. Under extreme-case testing

with excessive impoundment, the installation did not undergo catastrophic failure and overtopped. Due to the structural performance improvements shown without adding additional installation efforts or cost, the 6 in. (15.2 cm) offset trench was adopted for testing of all other modifications.

Despite the reduced height of installation, the silt fence fabric still experienced excessive sagging, leading to the effective height of the installation being reduced as much as nearly 6 in. (15.2 cm) from the height at the posts and zip-ties partially tearing through the fabric at the attachment points to the posts at the top of the fabric. The hydraulic pressure of the impoundment on the fabric led to it being pushed downstream, leading to the effective height reduction of the installation. M2, using 2 in. by 2 in. (5.1 cm by 5.1 cm) wooden posts instead of studded steel T-posts, was developed due to wooden posts allowing for the attachment of fabric to posts using staples along the entire height of the post without causing holes in the fabric instead of solely at the top of the fabric where zip-ties must be attached. Under testing of Nebraska standard conditions and the extreme-case storm event, sagging was visibly reduced compared to M1 but still occurred. Figure 3.14 shows the reduced sagging experienced by M2.



**Figure 3.14 Reduced Sagging Experienced by M2**

To further reduce sagging, M3 was developed, which replaces the woven fabric used in the standard installation with a fabric with built-in polypropylene mesh backing. All other installation materials and methods were identical to M1. Testing to determine if the backing was effective in aiding structural performance was inconclusive; impoundment under testing of this fabric never exceeded 7.5 in. (19.1 cm) in depth, which was not enough for sagging or a lack of sagging to be evident. The lack of impoundment was due to the fabric having a larger apparent opening size at 0.023 in. (0.595 mm) than the other woven silt fence fabric tested, which had an apparent opening size of 0.0083 in. (0.21 mm). The larger opening size, combined with the lower flow rate experienced by the installation compared to past testing of the same fabric, led to pores in the fabric being unable to be clogged by sediment and to facilitate greater impoundment (Whitman et al. 2019b). Even under an extreme-case simulated stormwater runoff event, impoundment was unable to reach levels facilitated by the woven silt fence fabric.

Another common issue experienced by silt fences in prior field monitoring and testing and through Nebraska DOT testing that can cause installation failure is impoundment being allowed to pool behind the installation for excessive periods, caused by pores becoming clogged with sediment. Impoundment not being fully dewatered between storm events can lead to reduced storage area behind installations, potentially causing excessive impoundment, failure, or overtopping when subjected to future storm events (Whitman et al. 2021a). Under testing of the Nebraska DOT standard, M1, and M2, impoundment only decreased less than 3 in. (7.6 cm) during the 90-min observation dewatering period after the conclusion of flow introduction. Additionally, it took up to three days for the installation to fully dewater. To aid in the dewatering process, M4 was developed, which includes the dewatering board with overflow weir shown in Figure 3.12; a similar modification to the Alabama DOT standard silt fence was made by Whitman et al. (Whitman et al. 2021a). Included in the installation were three 0.75 in. (1.91 cm) diameter orifices and a V-notched weir at a height of 12 in. (30 cm). The height of 12 in. (30 cm) was used instead of the 18 in. (46 cm) used by Whitman et al. due to Nebraska conditions rarely reaching 12 in. (30 cm) of impoundment and never reaching 18 in. (46 cm) in depth. Additionally, the orifices were reduced from 1 in. (2.54 cm) in diameter to 0.75 in. (1.91 cm) due to the reduced impoundment and flow rate experienced. An energy-dissipating splash pad, consisting of an excelsior blanket and wattle, was installed directly downstream of the dewatering board to prevent downstream scour from flow passing through the dewatering orifices and overflow weir. Under 2-yr, 24-hr storm Nebraska conditions, impoundment behind M4 never reached the impoundment levels for flow to pass through the overflow weir. However, the installation experienced improved dewatering time, with dewatering completed in under 8 hours. Under an extreme-case simulated storm event, impoundment still failed to reach the

overflow weir due to sagging experienced by the silt fence fabric between posts, shown in Figure 3.15.



**Figure 3.15 Bypassing of Overflow Weir under Excessive Impoundment Conditions**

To prevent flow from bypassing the overflow weir and splash pad and causing scour downstream, the post spacing was adjusted from 6 ft (1.8 m) to 4 ft (1.2 m) to prevent excessive sagging from occurring and ensure flow overtopped the installation only at the dewatering board. Reducing the post spacing successfully reduced sagging and led to flow overtopping at the overflow weir under excessive impoundment and not in other locations along the installation, as shown in Figure 3.16.



**Figure 3.16 Overflow Weir Dewatering**

One installation of the silt fence MFE-I was run through the three back-to-back simulated storm events without an installed energy dissipation device to determine water quality through the dewatering board and the scour caused by flow passing through the board. Figure 3.17 shows that downstream erosion did occur, indicating a need for an energy dissipation device to prevent further erosion off-site.



**Figure 3.17 Scour Downstream of Dewatering Board Installation without Energy Dissipation Device**

Despite the addition of the dewatering board, the impoundment capabilities of the MFE-I were not greatly impacted. The maximum impoundment depth experienced by installations with the dewatering board installed was 11.875 in. (30.16 cm), only 0.875 in. (2.22 cm) less than the maximum impoundment of silt fence installations tested without the dewatering board installed.

The high porosity silt fence installation was not shown to form much impoundment, maxing out at 4.25 in (10.8 cm) in depth; any impoundment formed seemed to be due to the accumulation of material at the base of the installation. Figure 3.18 shows the lack of impoundment formed by high porosity silt fence installation during a simulated stormwater runoff event. The extreme-case simulated stormwater runoff did not facilitate any additional impoundment from testing of the standard conditions.



**Figure 3.18 Performance of High Porosity Silt Fence Installation**

Unlike prior testing on sediment barriers at AU-SRF, post deflection was not a major concern found through testing due to the lower flow rates experienced leading to less hydraulic force experienced by the silt fence posts. The maximum post deflection experienced by any of the three MFE-I installations tested was under 1 in. (2.54 cm).

#### **3.4.1.2 Water Quality Performance of Silt Fence**

To determine water quality improvement and means of improvement, the turbidity and TSS of water quality grab samples taken at the inflow, top and bottom of impoundment, and discharge were compared. The water quality of each fabric tested was evaluated separately due to considerable variation in impoundments created and flow-through rates facilitated. Table 3.1 summarizes silt fence turbidity and TSS data for the standard tests and modifications that used the same woven fabric as the standard. The turbidity and the TSS data demonstrated similar patterns, with the top of the impoundment having the lowest turbidity and TSS, the bottom of the impoundment having the highest, and the discharge falling between the two values. This data indicates that the water at the surface of the impoundment had the highest quality, with a degradation in water quality occurring deeper in the impoundment. The difference in water



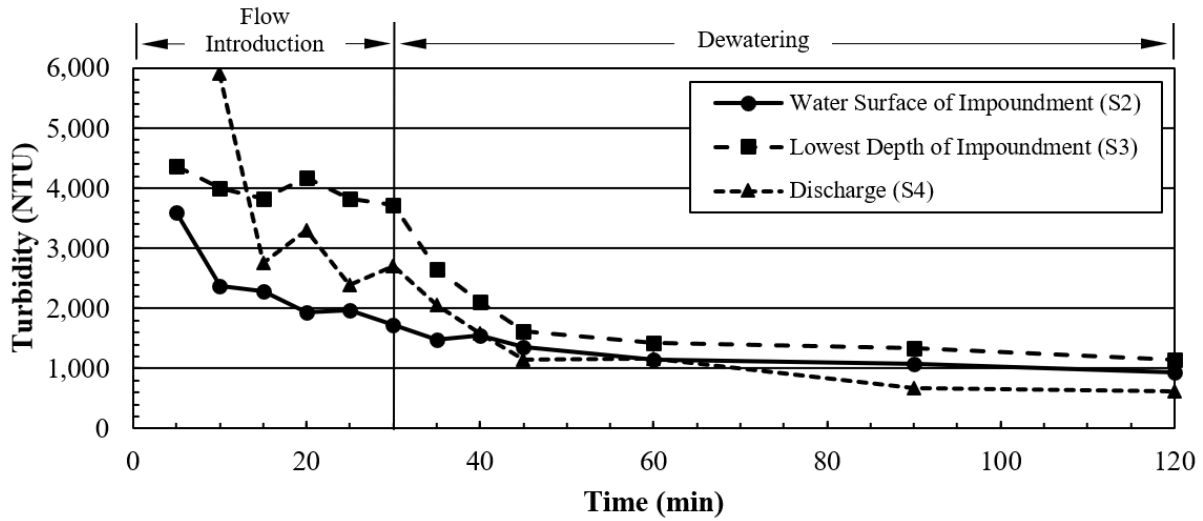
quality between the surface and lowest depth of the impoundment formed by the installation indicates water treatment through sedimentation within the impoundment.

**Table 3.1: Water Quality Data Across Woven Fabric Silt Fence Installations**

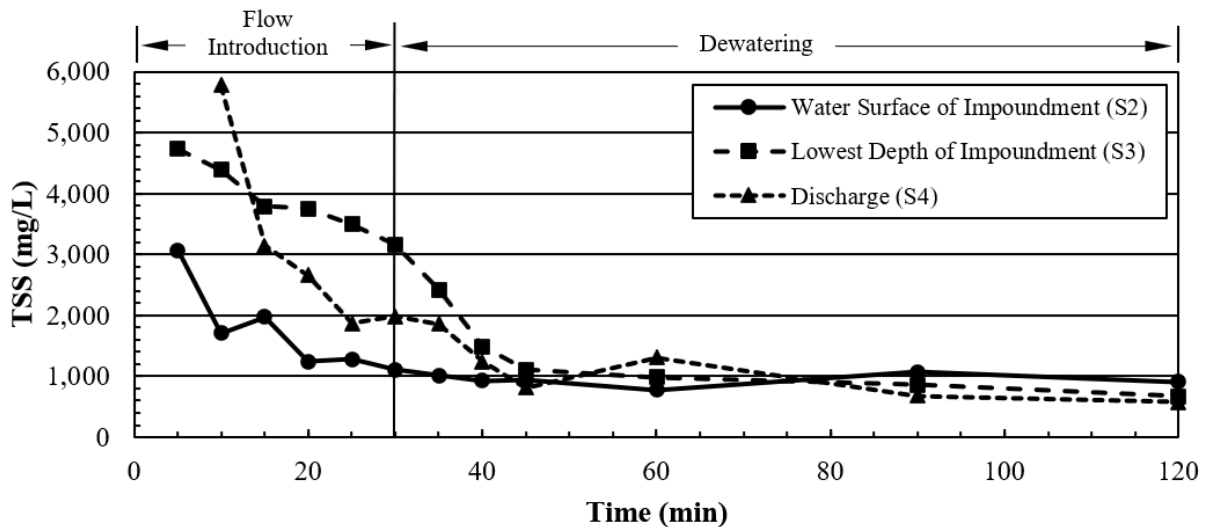
<b>Sample Location</b>	<b>Average Turbidity</b>	<b>Average TSS</b>
Water Surface of Impoundment (S2)	1,753 NTU	1,345 mg/L
Bottom of Impoundment (S3)	2,866 NTU	2,605 mg/L
Discharge (S4)	1,907 NTU	1,644 mg/L
Dewatering Board <sup>[a]</sup>	2,492 NTU	1,152 mg/L
Difference between S2 and S3	-38.8%	-48.4%
Difference between S2 and S4	-8.08%	-18.2%
Difference between S3 and S4	50.3%	58.5%

*[a] Only one installation had samples taken from the dewatering board*

Figure 3.19 displays the average turbidity and TSS through the test period and the 90-minute dewatering period. For much of the period of sediment-laden flow introduction, the lowest depth of the impoundment had the highest turbidity and TSS, while the water's surface had the lowest. After the flow introduction stops, the turbidity and TSS lowers across all sampling locations and steadily declines; discharge turbidity and TSS drops below 1,000 NTU and 1,000 mg/L of TSS.



(a) Average turbidity over time for woven silt fence installations



(b) Average TSS over time for woven silt fence installations

**Figure 3.19 Water Quality Over Time for Woven Silt Fence Installations**

To determine statistically the method of water quality treatment of turbidity (i.e., sedimentation within impoundment or filtration through the geotextile fabric), un-paired t-tests at a 95% confidence interval were used between samples taken at the water surface of impoundment and bottom of impoundment and the water surface of impoundment and discharge. The results of the analyses are shown in Table 3.2. Due to the P-value of the analysis of turbidity between the top and bottom of the impoundment formed behind the silt fence installations being

far under the 0.05 confidence level, the turbidity at the surface of the impoundment is statistically significantly less than the turbidity at the lowest depth of the impoundment. However, due to the P-value of the difference being above the 0.05 confidence level, there is no statistically significant difference between the turbidity of the water at the top of the impoundment and the discharge through the silt fence fabric. Analysis indicates that any treatment of sediment-laden stormwater in turbidity is due to sedimentation of sediment particles within the impoundment rather than filtration through the silt fence fabric.

**Table 3.2: Statistical Analysis of Impoundment and Discharge Turbidity**

	<b>Mean Diff. (NTU)</b>	<b>df</b>	<b>T-calc</b>	<b>P-value</b>
S2 – S3	-1,113	416	-7.179	<0.0001
S2 – S4	-154.1	237	-0.938	0.3492

Due to the polypropylene-backed fabric and the high porosity silt fence fabric facilitating less impoundment, water quality analysis was conducted separately. Table 3.3 shows the water quality results for the backed fabric. Despite the relatively low impoundment facilitated by Modification 3, water grab samples show a similar pattern to other silt fence testing, with turbidity and TSS being higher at the top of the impoundment than at the bottom. Both the turbidity and TSS of the discharge were higher than the discharge than that of the woven silt fence fabrics tested.

**Table 3.3: Water Quality Data Across Testing of Backed Silt Fence Fabric**

<b>Sample Location</b>	<b>Average Turbidity</b>	<b>Average TSS</b>
Water Surface of Impoundment (S2)	1,716 NTU	1,677 mg/L
Bottom of Impoundment (S3)	2,492 NTU	3,056 mg/L
Discharge (S4)	2,138 NTU	2,236 mg/L
Difference between S2 and S3	-31.2%	-45.1%
Difference between S2 and S4	-19.8%	-25.0%
Difference between S3 and S4	16.6%	36.7%

Due to the impoundment for the high porosity silt fence being lower than all other installations tested, a grab sample from the bottom of the impoundment could not be taken during any of the three simulated stormwater runoff events. Table 3.4 summarizes water quality of the high porosity silt fence installation. Of all silt fences tested, the high porosity installation had the highest discharge turbidity and TSS due to flow being able to easily pass through and the installation being wholly ineffective in capturing sediment and facilitating impoundment.

**Table 3.4: Water Quality Data Across Testing of High Porosity Silt Fence Installation**

<b>Sample Location</b>	<b>Average Turbidity</b>	<b>Average TSS</b>
Water Surface of Impoundment (S2)	4,459 NTU	16,437 mg/L
Discharge (S4)	3,691 NTU	5,831mg/L
Difference between S2 and S4	17.22%	64.53%

### 3.4.1.3 Sediment Retention Performance of Silt Fence

Silt fences tested under simulated storm events varied in sediment capture and were correlated with the fabric used. Woven silt fence fabric installations (i.e., STD, M1, M2, M4, M5) averaged 83% of introduced sediment captured. The introduction of the dewatering board

did not reduce the sediment capture capabilities of the silt fence installations; the four installations with the dewatering board averaged 86% sediment capture.

Modification 3 with the polypropylene-backed fabric and the High Porosity Silt Fence experienced less capture than all other silt fence installations with 67% and 70%, respectively. Much of this sediment capture for these installations can also be attributed to the reduction in flow velocity at the change in slope at the front of the test bed and along the test bed, as 66% of introduced sediment was captured through three simulated stormwater runoff events run with only a plastic lining in the test bed. The reduced sediment capture exhibited by these two installations is likely due to the lack of impoundment capabilities shown through testing.

### **3.4.2 Slash Mulch Berm Results**

One installation of the Nebraska DOT standard slash mulch berm installation was tested, along with two modified installations. Each of the two modified installations had the goal of facilitating greater impoundment and lowering the flow rates through the berm while using less material. The standard and modified installations are described below:

- Standard Nebraska DOT Installation (STD): standard used on Nebraska highway construction projects; trapezoidal berm 3 ft (0.91 m) in height and 6 ft (1.8 m) in width with a top width of 2 ft (0.61 m). The berm was not compacted.
- Modification 1 (M1): Berm with a height of 1.5 ft (0.46 m) and 3 ft (0.91 m) in width. Berm was compacted in three 6 in. (15.2 cm); each lift was compacted with a jumping-jack compactor.
- Modification 2 (M2): Berm with height of 1 ft (0.3 m) and 6 ft (1.8 m) in width; compacted in two 6 in. (15.2 cm lifts)

Figure 3.20 shows all three installations; specifications of all three are shown in Appendix C. The test bed for each installation was lined with plastic sheeting to facilitate the collection of deposited soil upstream and the analysis of sediment reaching the catch basin downstream of the test bed. Additionally, each berm was installed with the back face on the far downstream end of the test bed, to prevent additional deposition from occurring between the installation and the catch basin. This testing methodology adjustment for slash mulch berms was developed through testing of slash mulch berms under Alabama conditions for Alabama Power. Three installations of a trapezoidal slash mulch berm 3 ft (0.91 m) in height and 6 ft (1.8 m) in width with a 6 in. (15.2 cm) key in were tested under Alabama conditions. The results and methodology of this testing can be found in Appendix A; findings from testing were used to develop modifications to Nebraska DOT slash mulch berms.



(a) standard installation



(b) modification 1



(c) modification 2

**Figure 3.20 Slash Mulch Berm Installations**

### 3.4.2.1 Structural Performance of Slash Mulch Berm

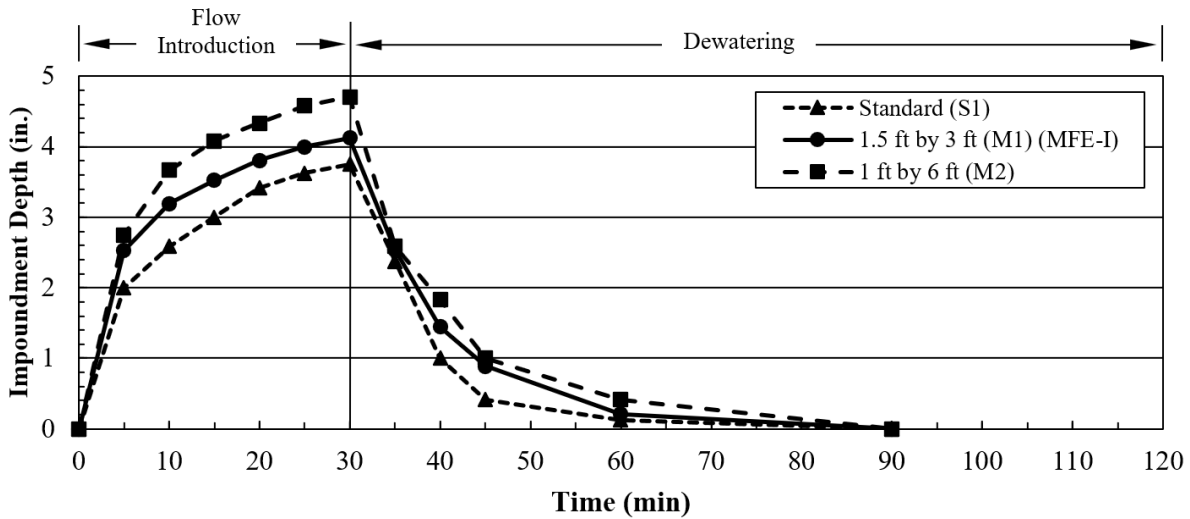
The standard Nebraska DOT slash mulch berm installation facilitated only a maximum impoundment depth of 4 in. (10.2 cm); the majority of material within the berm, approximately 2.7 ft (0.82 m) of the total height, does not have any flow pass through and only is serving to ensure the berm does not wash away as runoff passes through it. Figure 3.21 shows the impoundment formed by the installation; it does not reach far up the front face of the installation. The first discharge through the installation took just over 3 minutes after the beginning of flow introduction; each subsequent test required less time for flow to pass through the installation. The little impoundment formed behind the berm dewatered within 60-min of the conclusion of flow introduction. Under the extreme-case simulated stormwater runoff, minimal additional impoundment was achieved; however, the berm remained structurally sound and there was no substantial loss of material from the berm.



**Figure 3.21 Impoundment formed by Nebraska DOT Slash Mulch Berm Standard**

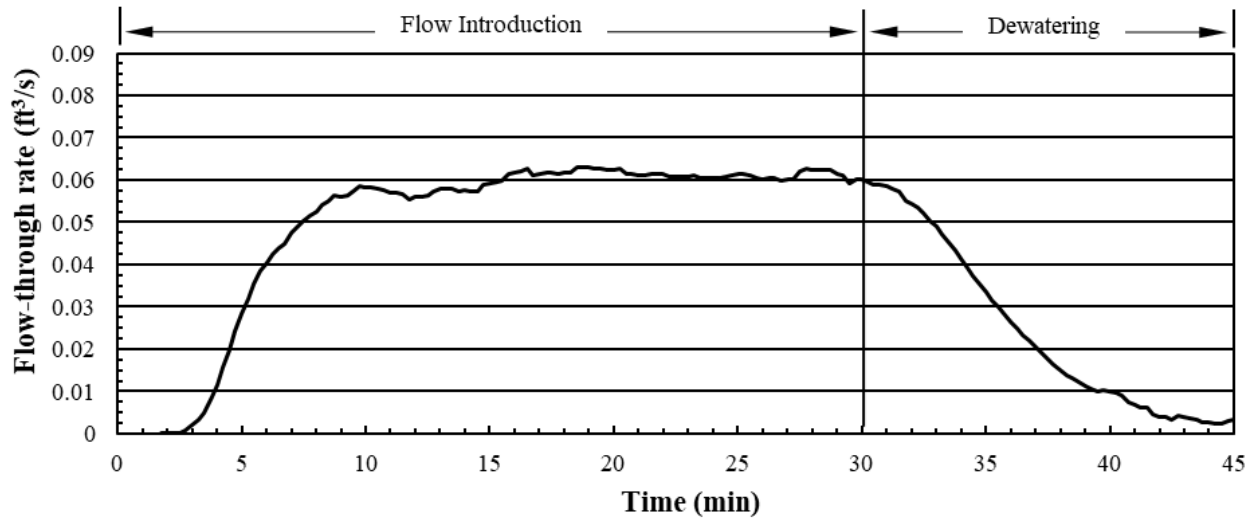


To facilitate greater impoundment and slowing of stormwater flow using less material, two modifications were developed that reduced the profile of the berm and used compaction to aid in impoundment capabilities. M1, with a height of 1.5 ft (0.46 m) and a width of 3 ft (0.91 m) constructed in three compacted lifts, had a maximum impoundment depth of 4.875 in. (12.38 cm). M2, which was developed to increase the length of the flow path through the berm and had a height of 1 ft (0.3 m) and a width of 6 ft (1.8 m), had a slightly deeper maximum impoundment at 5 in. (12.7 cm). However, this could be due to the decreased potential for impoundment length due to the berm taking up more of the test bed rather than the increased width of the installation. The impoundment length for M1 was able to be more than 100 in. (254 cm) during the first simulated storm event; the maximum impoundment length for M2 was only 87 in. (221 cm). Figure 3.22 shows the average impoundment depth for all three slash mulch berm installations. Both modifications did not experience overtopping or loss of material under extreme-case simulated stormwater runoff conditions; however, little additional impoundment was facilitated when compared to standard conditions. The same pattern of impoundment depth was shown during the test period of all three installations, with a rapid, immediate rise as flow starts and slowing as the maximum impoundment capability of each installation is reached. All three installations dewatered fairly quickly, with a slower dewatering of the two modifications than standard.



**Figure 3.22 Average Impoundment of Slash Mulch Berm Installations**

Due to M1 facilitating similar impoundment and flow rates to M2 while using less material, M1 was chosen as the MFE-I, and two additional installations of the same design were tested. Both modifications slowed flow through the installations. The average flow rate of the peak 30-min of flow through the berm, starting typically two and half minutes after flow introduction begins, during the test period were 0.056 and 0.061 ft<sup>3</sup>/s (0.0016 and 0.0017 m<sup>3</sup>/s), respectively. Figure 3.23 shows the average flow rate into the catch basin for the MFE-I slash mulch berm installation. Each test of the MFE-I took an average of over two and a half minutes for flow to first pass through the installation and into the catch basin. A filling period where the flow rate is lower, taking approximately five minutes after flow first passes through the berm, is indicated. Flow rate through the berm stays steady throughout the rest of the test period at approximately 0.06 ft<sup>3</sup>/s (0.0017 m<sup>3</sup>/s). At the conclusion of flow introduction, flow through the berm reduces steadily during the first ten minutes of the dewatering period until reaching close to zero approximately 15 minutes after flow introduction stops.



**Figure 3.23 Average Flow Rate through MFE-I Slash Mulch Berm Installations**

### 3.4.2.2 Water Quality Performance of Slash Mulch Berm

Both modifications performed similarly in water quality, as shown in Table 3. There was a considerable decrease in both turbidity and TSS through the installation, as shown by the comparison between the grab samples taken at the discharge and both the top and bottom of the impoundment. There was a reduction in both turbidity and TSS from the top to the bottom of the impoundment on average due to sedimentation within the impoundment; however, this reduction was less than other installations that were able to facilitate greater impoundment.

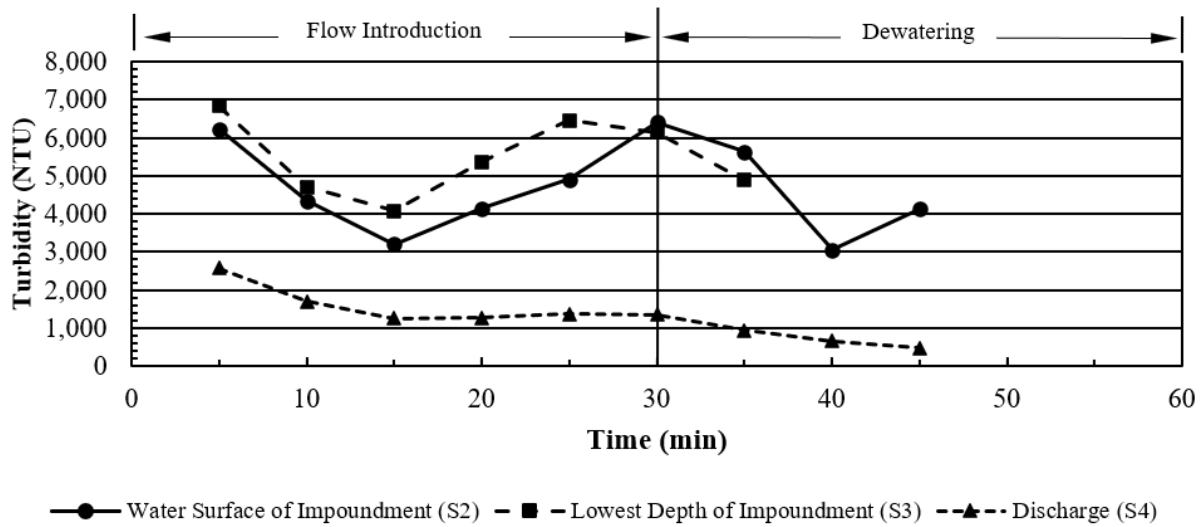
**Table 3.5: Water Quality Data for Slash Mulch Berms**

	M1 (MFE-I) <sup>[a]</sup>	M2 <sup>[b]</sup>
<b><u>Average Turbidity</u></b>		
<b>Water's Surface of Impoundment (S2) (NTU)</b>	4,666	4,845
<b>Bottom of Impoundment (S3) (NTU)</b>	5,495	5,066
<b>Discharge (S4) (NTU)</b>	1,181	1,603
<b>S2-S3 (%)</b>	-17.78	-4.56
<b>S2-S4 (%)</b>	74.69	66.91
<b>S3-S4 (%)</b>	78.51	68.35
<b><u>Average TSS</u></b>		
<b>Water's Surface of Impoundment (S2) (mg/L)</b>	5,175	4,642
<b>Bottom of Impoundment (S3) (mg/L)</b>	7,361	7,423
<b>Discharge (S4) (mg/L)</b>	782.4	1,090
<b>S2-S3 (%)</b>	-42.25	-59.91
<b>S2-S4 (%)</b>	84.88	76.53
<b>S3-S4 (%)</b>	89.37	85.32

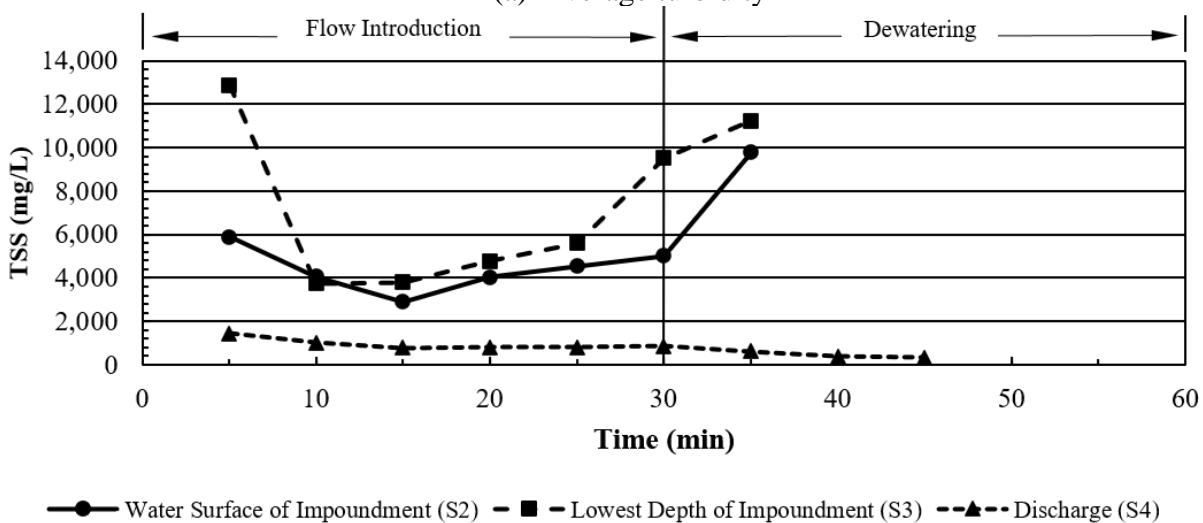
*[a] Three installations tested three times*

*[b] One installation tested three times*

Figure 3.24 shows the average water quality over time for the slash mulch berm MFE-I installations. On average, through both the testing period and the dewatering monitoring period, the turbidity and TSS of the discharge are lower than both the top and bottom of the impoundment, indicating treatment through the installation. Additionally, for much of the test period, the turbidity and TSS of the top of the impoundment are lower than the bottom; however, both increase through the test period on average. Water quality at the two sampling locations in the impoundment also becomes similar as the dewatering period leads to lower impoundment facilitated upstream of the practice, leading to samples being taken from similar locations within the impoundment.



(a) Average turbidity



(b) Average TSS

**Figure 3.24 Water Quality Performance of MFE-I Slash Mulch Berm Installations**

### 3.4.2.3 Sediment Retention Performance of Slash Mulch Berm

The Nebraska DOT standard slash mulch installation captured only 61% of introduced sediment upstream of the berm due to the low impoundment level facilitated by the installation; however, only 1.9% of the introduced sediment was recovered from the catch basin. The difference between the two values indicates that approximately 37.5% of the introduced sediment was captured within the berm itself. M1, primarily due to the greater impoundment

facilitated by the compacted material, captured an average of 73.5% of introduced sediment upstream of the barrier; approximately 1.1% of sediment on average was recovered from the catch basin, indicating that 25.4% of sediment was captured within the berm, even with its reduced profile compared to the standard installation. Modification 2, due to causing more impoundment than the standard and Modification 1, captured the most sediment upstream with 78.2%.

### **3.4.3 Straw Wattle Results**

One installation of the Nebraska DOT straw wattle installation was tested, along with two modified installations. Each of the two modified installations had the goal of facilitating greater impoundment behind the installation in both testing of standard conditions. The standard and modified installations are described below:

- Standard Nebraska DOT Installation (STD): standard used on Nebraska highway construction projects; 1 ft (0.31 m) straw wattles attached to the ground using 1 in. by 2 in. by 24 in (2.54 cm by 5.08 cm by 61 cm) nominal wooden stakes through the center of the wattle at least 3 in. (7.6 cm) above the surface of the wattle and 12 in. (30.5 cm) into the ground with a 3 in. (7.6 cm) deep trench. Joints overlap by 1 ft (0.31 m). Wattles are installed 10 ft (3.04 m) from the toe of the slope. Installation detail is shown in option B in Figure 3.4
- Modification 1 (M1): 1 ft (0.31 m) straw wattles attached to the ground using 6 in. (15.2 cm) sod staples every 1 ft (0.31) off center on either side of the wattle. No trench was used; joints and distance from the toe of the slope were kept identical to the standard installation.

- Modification 2 (M2): identical to M1, with the addition of 1 in. by 2 in. by 24 in (2.54 cm by 5.08 cm by 61 cm) nominal wooden stakes installed at the joints at 45-degree angle, nondestructively. Joint overlap was increased from 1 ft (0.31 m) to 2 ft (0.62 m).

Figure 3.25 shows all three types of installations. For each installation, three 10 ft (3.04 m) long wattles were used. Wattles at the end of each side were turned upstream and tucked against the side walls of the testing apparatus to ensure flow passes through the installation and prevent flow bypass. Additionally, a straw blanket was added in the test bed downstream of the wattle installation to prevent flow overtopping the wattle from causing additional erosion downstream of the installation and allowing for the analysis of sediment discharged into the catch basin downstream of the test bed.



(a) straw wattle standard installation



(b) modification 1



(c) modification 2

**Figure 3.25 Straw Wattle Installations**

### 3.4.3.1 Structural Performance of Straw Wattles

Immediately after the start of flow introduction into the standard straw wattle installation, stormwater could pass beneath the installation, as shown in Figure 3.26. The stakes that attached the wattles to the ground did not facilitate ground contact with the straw wattle. Minimal impoundment was facilitated; the maximum impoundment through testing was 1.5 in. (3.8 cm),



and a high flow-through rate was apparent. Due to the evident failure of the installation in facilitating any impoundment or treating stormwater, only one test of one installation was run. Additionally, no impoundment was facilitated under the higher flow rates during the extreme-case simulated stormwater runoff event.



(a) undermining



(b) high flow through-rate

**Figure 3.26 Straw Wattle Standard Installation Undermining**

To further facilitate ground attachment between the wattle and ground, M1 was developed, which adds sod staples spaced every 1 ft (0.3 m) on each side of the installation. Staples were added upstream and downstream and staggered to maximize contact between wattles and the ground. Adding staples facilitated more impoundment than the standard installation, with a maximum impoundment of 5.25 in. (13.3 cm), as shown in Figure 3.27a. The impoundment depth, however, did not reach the maximum height of the wattle; flow could overtop the installation at the joints between wattles, where the effective height of the installation was the lowest, shown in Figure 3.27b. The impoundment also was limited to the height of the joints between wattles under extreme-case simulated stormwater runoff conditions.



(a) impoundment facilitated



(b) overtopping of flow at junctions

**Figure 3.27 Performance of Straw Wattle Modification 1**

To prevent flow from overtopping at the joints and allowing impoundment to reach the entire height of the installation, M2 was developed that included wooden stakes were added at the joints between wattles at a 45-degree angle in an A-frame or teepee configuration that does not puncture the wattles in addition to increasing the overlap at the joints between the wattles. Sod stapling pattern was kept the same from M1. The goal of adding stakes at the joints is to facilitate contact between the wattles and preventing the area at the joints from having a lower effective height, therefore prevent flow bypass between the wattles. Under testing, an impoundment depth greater than M1 with only sod staples was facilitated, with a maximum depth of 6.825 in. (17.34 cm) facilitated, which was the height at which the installation overtopped as shown in Figure 3.28. Overtopping was also facilitated during the extreme-case simulated stormwater runoff event.



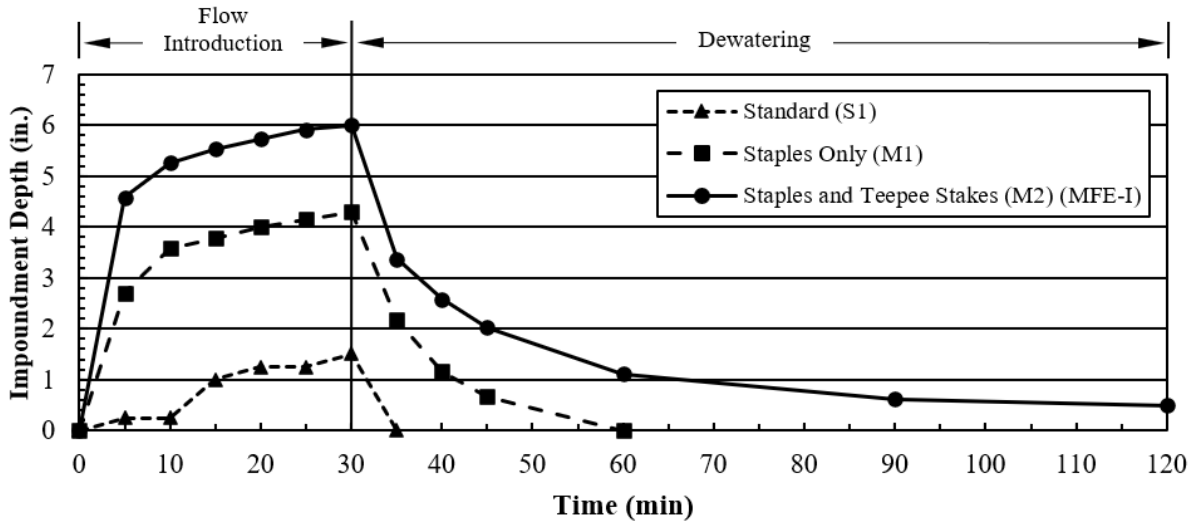
(a) impoundment facilitated



(b) overtopping of installation

**Figure 3.28: Performance of Straw Wattle Modification 2**

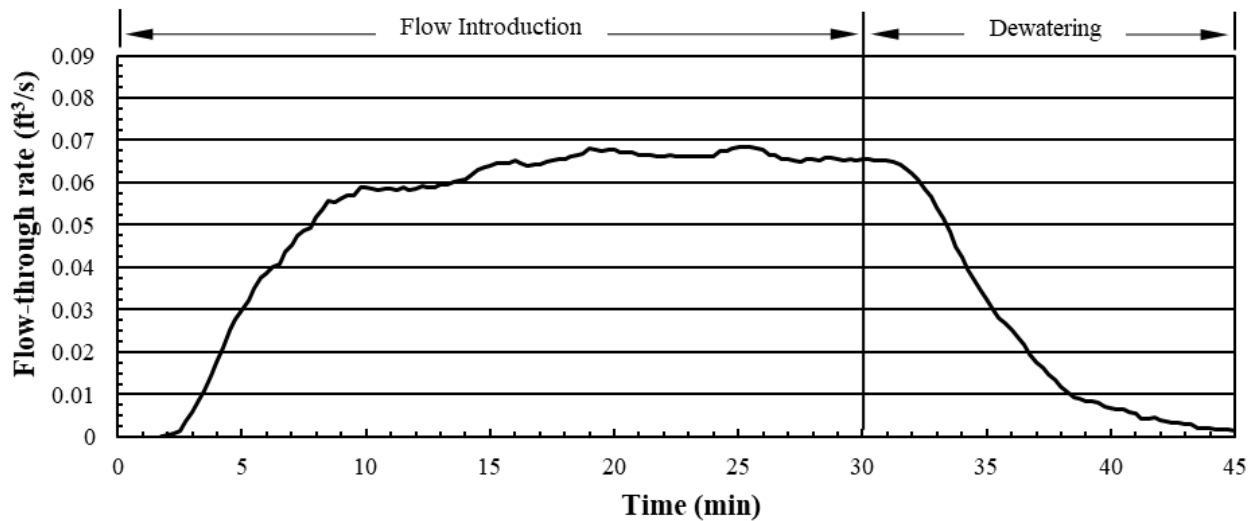
Due to M2 facilitating greater impoundment than both the standard installation and Modification 1, as well as not greatly increasing the cost of both labor and material, it was selected as the MFE-I for straw wattles. Figure 3.29 compares impoundment depth through the test period and the 90-minute monitored dewatering period. Only one test is represented for the standard installation; the depths for M1 and M2 were averages through the three and nine simulated stormwater events, respectively. M1 and M2 demonstrated approximately the same pattern, with impoundment quickly growing from the start to the time of the first measurement and then slowly growing before reaching a maximum point of either bypassing between joints or overtopping entirely. After flow introduction ceases, impoundment drops quickly and then slows before fully dewatering. All tests of M1 completely dewatered within 30 minutes after the stop of flow introduction. Two simulated stormwater runoff events on M2 had impoundment present at the end of the 90-minute dewatering monitoring period, each of which was the third and final runoff event for that installation.



**Figure 3.29: Average Impoundment Depth for Straw Wattle Installations**

As each installation was tested, impoundment depth grew compared to the previous test. For M2, impoundment at each point in the test period was 1.75 in. (4.45 cm) deeper on average during the third simulated stormwater runoff event compared to the first runoff event, with maximum depth increasing by 1.5 in. (3.81 cm). M1 demonstrated a similar pattern, with impoundment increasing by 2.375 in. (6.03 cm) on average. The increase in impoundment between tests is likely due to the clogging of the straw wattle with sediment during each subsequent simulated event, which would facilitate a lower flow-through rate through the installations.

Figure 3.30 shows the average flow-through rate for all nine simulated stormwater runoff events of M2, the MFE-I. The graph demonstrates that flow does not fully pass through the installation until over 2 minutes into the start of flow introduction, as well as a filling period of the area upstream of the straw wattle, with flow rates stabilizing at approximately 0.065 ft<sup>3</sup>/s (0.0018 m<sup>3</sup>/s) within 10 minutes of the start of the simulated runoff event. After flow ceases, the flow rate slows until reaching effectively zero about 10 minutes after flow introduction stops.



**Figure 3.30 Average flow rate through Straw Wattle MFE-I Installations**

### 3.4.3.2 Water Quality Performance of Straw Wattles

Across testing of straw wattles, water quality performance varied through installations. Table 3.6 shows water quality data across the three installation types of straw wattles. The standard installation could not be sampled at the bottom of the impoundment and at many sampling times at the top due to the lack of impoundment formed. Both modified installations showed a decrease in turbidity and total suspended solids through the installation due to the grab samples at the discharge having lower turbidity and TSS than the impoundment upstream of the practice. Modification 1 had higher turbidity and TSS at the top of the impoundment than at the bottom; this was likely due to the fairly low impoundment facilitated by the installation. Additionally, matter that had been present within the introduced sediment was observed to be floating on the top of the impoundment. Under the higher impoundment conditions facilitated by the MFE-I, the turbidity and TSS at the bottom of the impoundment were higher than the water's surface, indicating that sedimentation is occurring.

**Table 3.6: Water Quality Data for Straw Wattles**

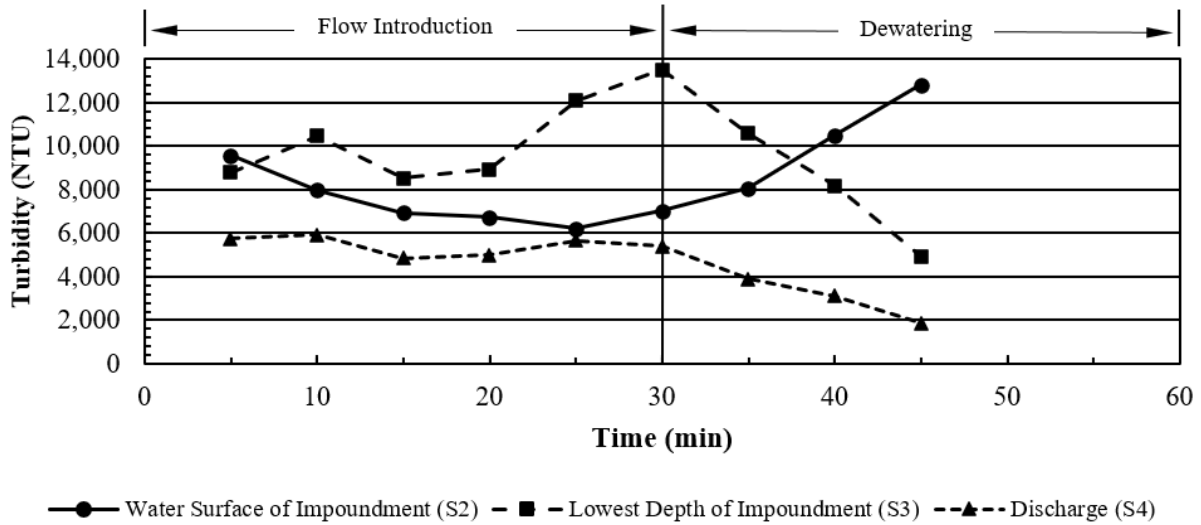
	STD <sup>[a]</sup>	M1 <sup>[b]</sup>	M2 (MFE-I) <sup>[c]</sup>
<b><u>Average Turbidity</u></b>			
<b>Water's Surface of Impoundment (S2) (NTU)</b>	13,235	5,314	8,418
<b>Bottom of Impoundment (S3) (NTU)</b>	N/A	3,684	9,550
<b>Discharge (S4) (NTU)</b>	9,673	1,959	4,606
<b>S2-S3 (%)</b>	N/A	30.68	-40.20
<b>S2-S4 (%)</b>	26.92	46.81	33.16
<b>S3-S4 (%)</b>	N/A	63.12	52.34
<b><u>Average TSS</u></b>			
<b>Water's Surface of Impoundment (S2) (mg/L)</b>	16,095	3,847	5,206
<b>Bottom of Impoundment (S3) (mg/L)</b>	N/A	3,335	7,186
<b>Discharge (S4) (mg/L)</b>	7,645	1,446	3,251
<b>S2-S3 (%)</b>	N/A	13.30	-38.05
<b>S2-S4 (%)</b>	52.50	62.41	54.76
<b>S3-S4 (%)</b>	N/A	56.65	37.55

*[a] One installation tested once*

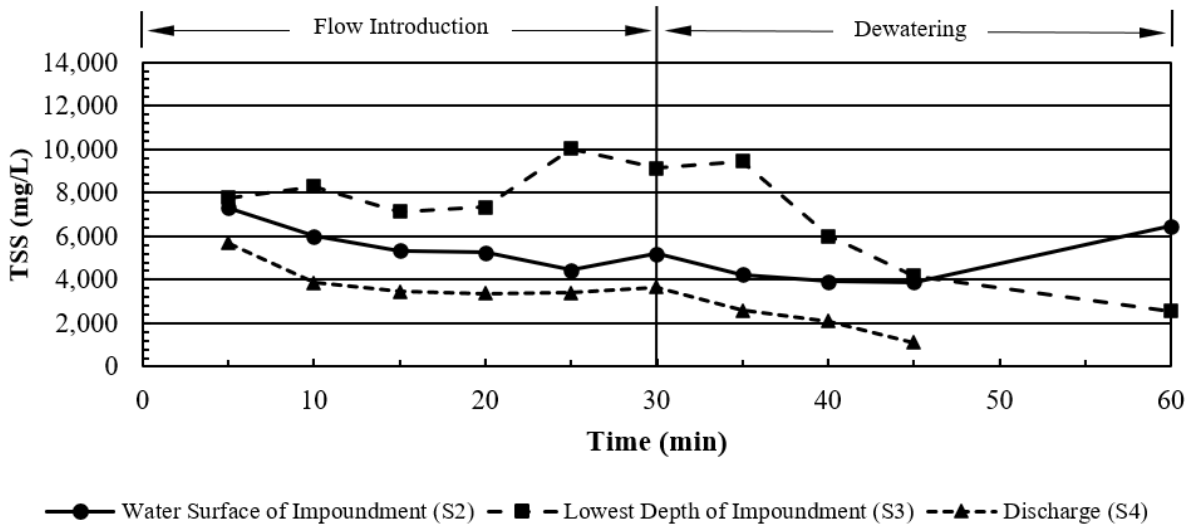
*[b] One installation tested three times*

*[c] Three installations tested three times each*

Figure 3.31 shows the average water quality over time for the MFE-I straw wattle installation. On average, through the testing period, the turbidity and TSS at the water's surface of the impoundment are lower than samples taken at the same time at the bottom of the impoundment. The difference in water quality within the impoundment demonstrates that there is water quality treatment occurring within the impoundment through the process of sedimentation. However, after the flow introduction stopped, the turbidity and total suspended solids at the top of the impoundment increased to reach and then exceed the bottom of the impoundment, likely due to the impoundment decreasing to the point where both samples are being taken from approximately the same area of impoundment.



(a) Average turbidity



(b) Average TSS

**Figure 3.31 Water Quality Data for Straw Wattle MFE-I**

### 3.4.3.3 Sediment Retention Performance of Straw Wattles

The Nebraska DOT standard straw wattle installation, due to the undermining that occurred immediately due to a lack of ground contact, did not facilitate considerable sediment capture upstream, with only 62.5% of introduced sediment being captured upstream. The addition of sod staples for Modification 1 allowed the formation of impoundment behind the practice and increased the sediment capture capabilities upstream of the installation, capturing

77.2% of introduced sediment. Adding teepee stakes at the joints to prevent flow bypass between wattles led to more impoundment facilitated, increasing the average sediment capture upstream to 80.8% of introduced sediment.

### **3.4.4 Excelsior Wattle Results**

Three installations of excelsior wattles were run using the MFE-I installation from straw wattles to allow for comparison of materials. Wattles were installed with sod staples every 1 ft (0.31 m) on either side; 1 in. by 2 in. by 24 in (2.54 cm by 5.08 cm by 61 cm) nominal wooden stakes were installed at 45-degree angles in an A-frame or teepee configuration.

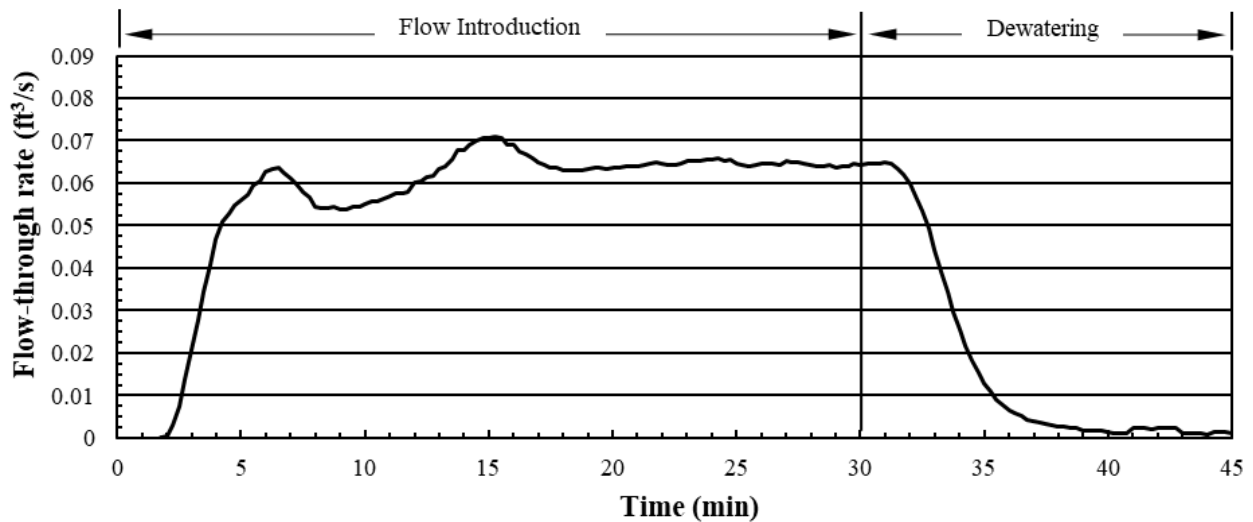
#### **3.4.4.1 Structural Performance of Excelsior Wattles**

Excelsior wattles impounded a maximum of 3.875 in. (9.843 cm) in depth. Impoundment increased during each subsequent storm event by an average of 0.90 in. (2.3 cm) during the test period from the first to the second simulated storm event and by an average of 0.65 in (1.65 cm) from the second simulated storm event to the third. Across all testing, all the impounded stormwater had been dewatered by the end of the 90-minute monitoring period after flow introduction. Despite the low impoundment facilitated by the installation, undermining was not indicated during testing due to impoundment growing during the duration of the test and in subsequent simulated storm events; impoundment growing in depth and length past approximately an inch and a half did not occur in wattle and other sediment barrier installations that were experiencing undermining or had ground contact inefficiencies.

Figure 3.32 shows the average flow rate through excelsior wattle installations. After flow first passed into the catch basin, which typically took an average of just under two minutes from the start of flow introduction, there was an immediate sharp rise in flow rate, followed by a slight reduction after the first flush. Flow then stabilizes at approximately 0.065 ft<sup>3</sup>/s (0.0018 m<sup>3</sup>/s) for



the rest of the test period. Shortly after the flow introduction concludes, the flow rate drops to effectively zero. Compared to the straw wattle installations, the flow rate rises faster at the start of each test period and falls faster after the conclusion of flow introduction; this, along with the lower impoundment and lack of overtopping, demonstrates that the excelsior wattle installations facilitated higher flow rates through the installations. The higher flow-through rate, as well as the lower impoundment facilitated by the excelsior wattles compared to the straw, is likely due to the wattles being less dense than the straw wattles. Straw wattles averaged a density of 4.58 lb/ft<sup>3</sup> (73.4 kg/m<sup>3</sup>); the excelsior wattles tested only averaged 3.95 lb/ft<sup>3</sup> (63.3 kg/m<sup>3</sup>).



**Figure 3.32 Flow through Excelsior Wattle Installations**

#### 3.4.4.2 Water Quality Performance of Excelsior Wattles

Table 3.7 shows the water quality performance of the three installations of excelsior wattles tested. The water grab samples taken from the top of the impoundment formed were higher in both turbidity and TSS than the bottom of the impoundment, likely due to the extremely low levels of impoundment that was facilitated by the excelsior wattle installations leading to little sedimentation being able to occur within the impoundment. There was a lowering of turbidity and TSS from the bottom of impoundment to the discharge of 37.9% and

36.9%, respectively; however, the average discharge turbidity and TSS were still 38.5% and 45.5% higher than the straw wattles tested using the same installation methods.

**Table 3.7: Water Quality Data for Excelsior Wattles**

<b>Sample Location</b>	<b>Average Turbidity</b>	<b>Average TSS</b>
Water Surface of Impoundment (S2)	21,938 NTU	18,475 mg/L
Bottom of Impoundment (S3)	12,062 NTU	9,466 mg/L
Discharge (S4)	7,490 NTU	5,970 mg/L
Difference between S2 and S3	45.0%	48.8%
Difference between S2 and S4	65.9%	67.7%
Difference between S3 and S4	37.9%	36.9%

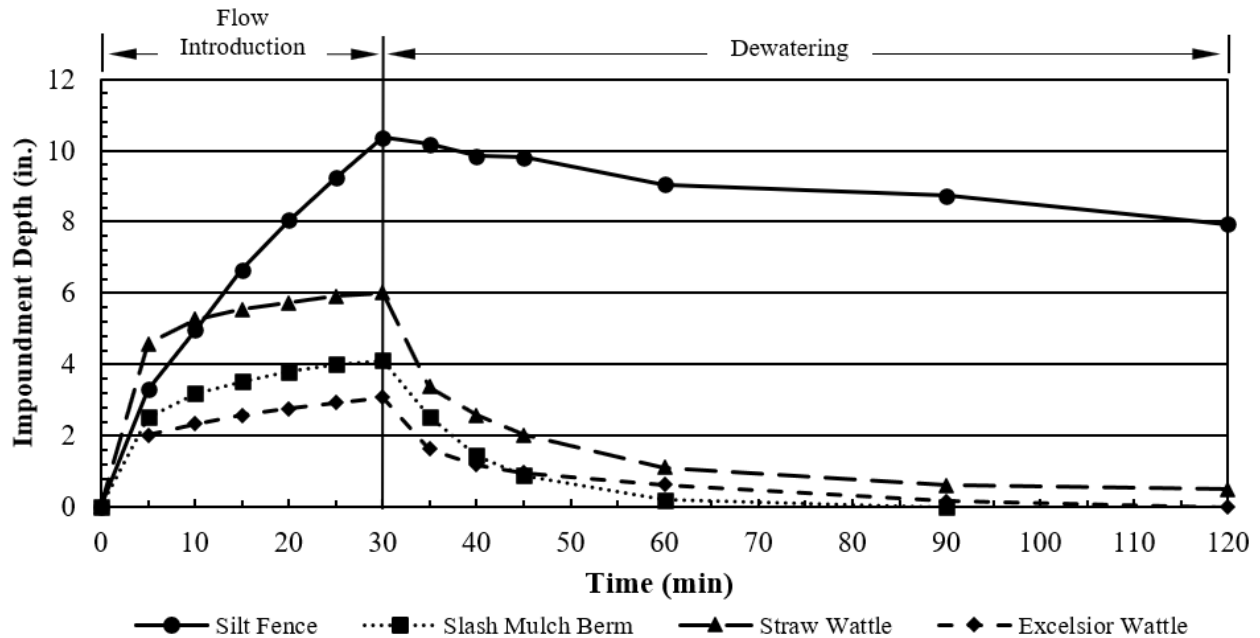
#### **3.4.4.3 Sediment Retention Performance of Excelsior Wattles**

The three excelsior wattle installations varied in sediment capture upstream, with an average of only 75.3% being deposited upstream of the barrier. This capture being lower than straw wattles installed using the same method is likely due to the lack of impoundment facilitated by the installation compared to the straw wattle installations.

### **3.5 Sediment Barrier Testing Comparison**

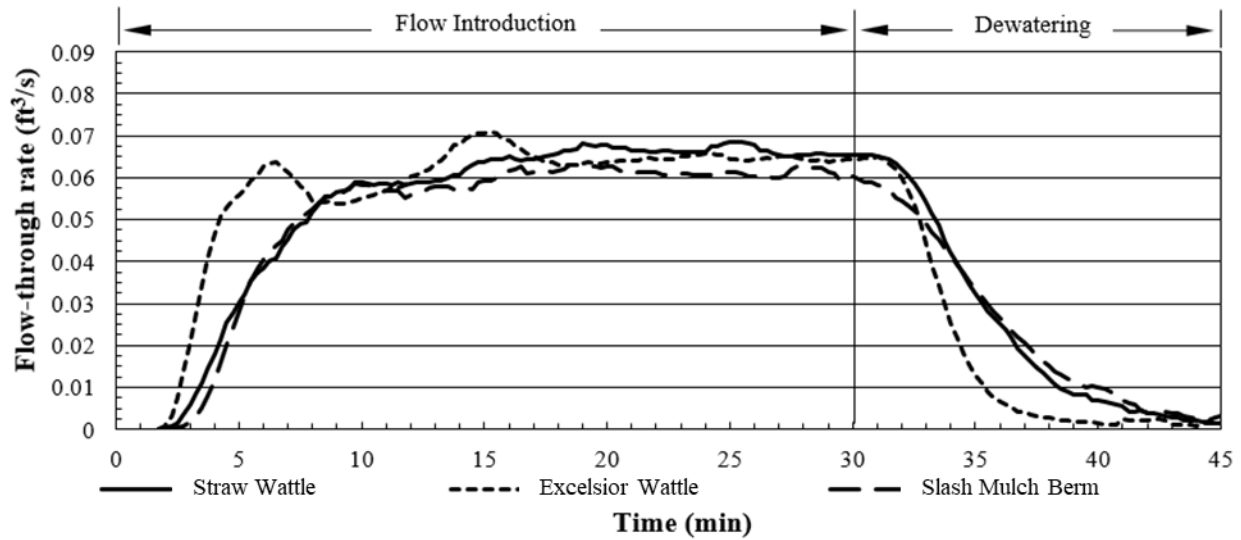
Each of the four MFE-I sediment barriers varied in all aspects of performance, including impoundment facilitated, flow-through rates, water quality treatment, and sediment capture. Figure 3.33 shows the average impoundment facilitated by each MFE-I sediment barrier. Silt fence had the highest impoundment during the flow introduction period and dewatering occurred at the slowest rate, even with the dewatering board. Slash mulch berms and wattles showed similar patterns at varying maximum impoundment levels, with an immediate filling period followed by a slower impoundment growth before dewatering quickly after flow introduction

stops. Excelsior wattles and slash mulch berms showed lower impoundment levels than straw wattles and were dewatered entirely within 90 minutes after flow introduction concluded in all tests.



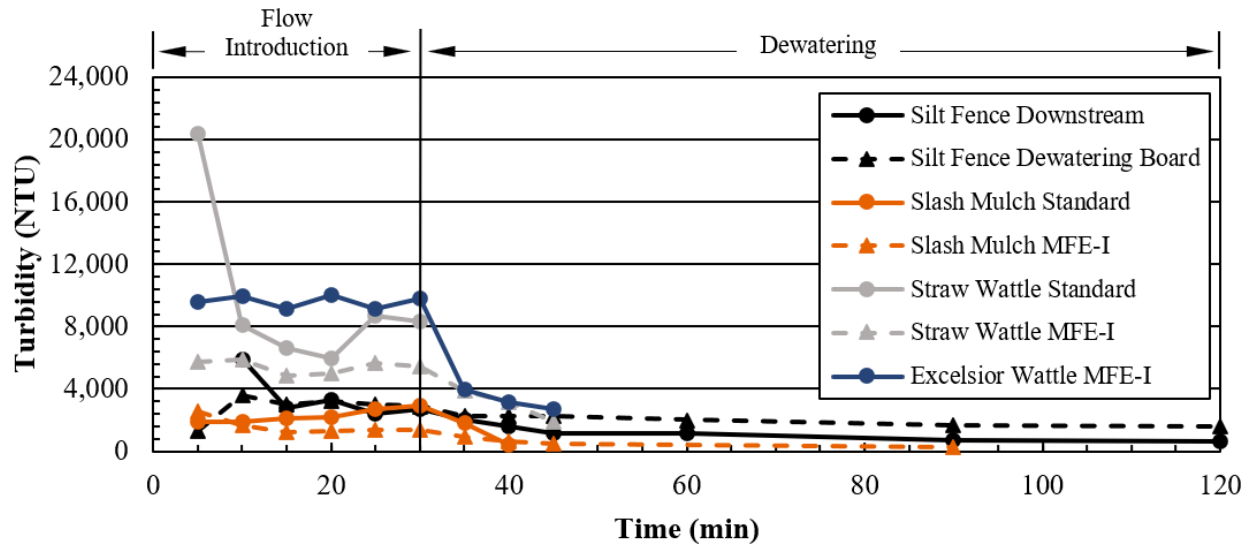
**Figure 3.33 Impoundment Facilitated by Sediment Barrier MFE-Is**

A similar pattern between MFE-I slash mulch berms and wattles is also shown in the moving average flow-through rate during testing, as shown in Figure 3.34. Straw wattles and slash mulch berms demonstrated nearly identical average flow-through rates, taking 2 minutes to run through the installation and into the catch basin. For MFE-I straw wattles and slash mulch berms, the flow-through rate then stabilized for the rest of the introduction period. Straw wattles had the highest flow-through rate at the end of the test period, likely due to tests where the installation overtopped. Excelsior wattles, on average, took less time for flow to pass through the installation into the catch basin and dewatered faster than slash mulch berm and straw wattle installations; additionally, flow started and stopped quickly without a clear filling period shown by slash mulch berms and straw wattles.

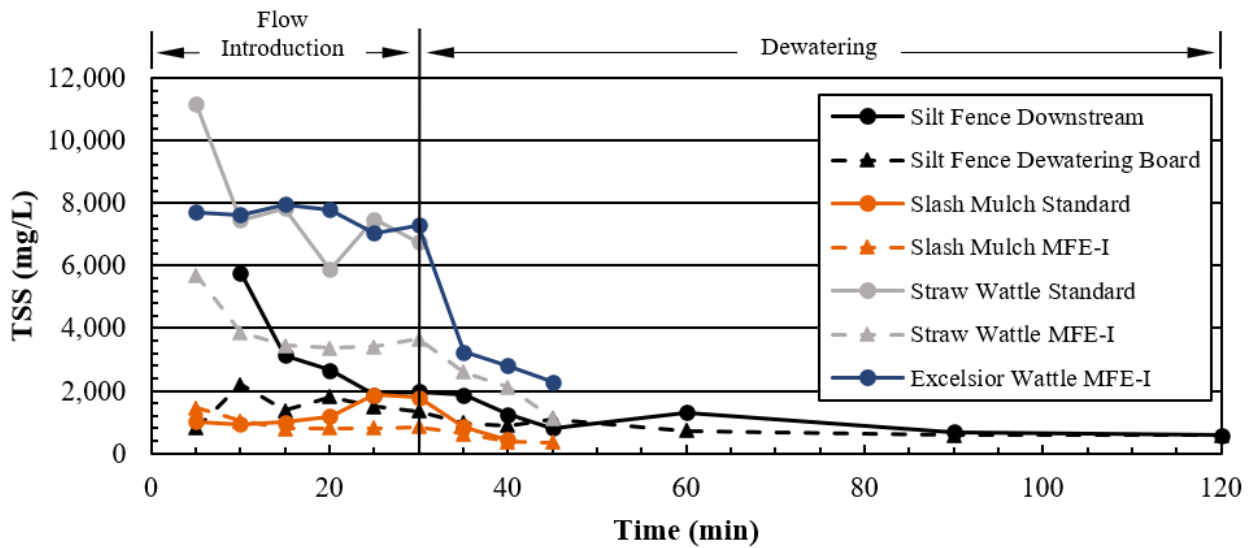


**Figure 3.34 Flow-through Rates of Sediment Barrier MFE-Is**

Water quality also varied widely between sediment barrier types and installations of the same type, as shown in Figure 3.35. Throughout silt fence testing, there was slight variation through testing of the same fabric; there was no apparent improvement in water quality between the standard installations that did not fail and the MFE-I installations. Samples taken from the dewatering board in the final MFE-I installation also did not show an evident variation in turbidity through the flow introduction period compared to through the silt fence fabric; TSS for samples taken from the dewatering board were lower on average than the TSS of discharge through the silt fence fabric.



(a) Average turbidity



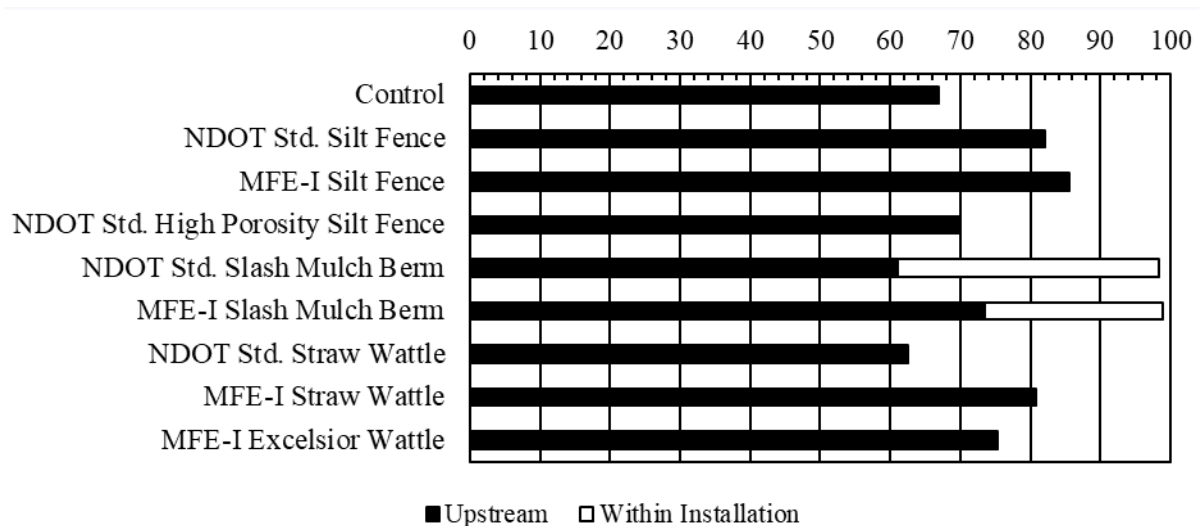
(b) Average TSS

**Figure 3.35 Discharge Water Quality of Tested Sediment Barriers**

For much of the sampling in the flow introduction and dewatering periods, the slash mulch berm MFE-I had lower discharge turbidity and TSS than the standard installation on average, indicating that the increased compaction, even with far less material, gave downstream water quality benefits. The straw wattle MFE-I, due to facilitating more impoundment than the standard, had lower discharge turbidity and TSS than the standard installation. Even with installation techniques that had increased the impoundment of straw wattles, the excelsior wattle

installations had similar or higher discharge turbidity and TSS as the straw wattle standard through the flow introduction period.

Each sediment barrier also varied in sediment capture, as shown in Figure 3.36. The control sediment capture for flow across the test bed without a sediment barrier installed was 67% and was due to velocity slowing as flow passed from the impervious slope and across the test bed. The four installations tested with the dewatering board with overflow weir and 6 in. (15.2 cm) offset trench (one with 6 ft (1.8 m) and three with 4 ft (1.2 m) post spacing) had an average of 85.5% sediment capture, an improvement from the standard. The high porosity silt fence installation captured only 70%, a 3% improvement over the baseline condition. The MFE-I silt fence installation captured only 70%, a 3% improvement over the baseline condition. The MFE-I slash mulch berm captured 12.5% more sediment upstream than the standard NDOT installation due to the increased compaction of the installation despite using less material. The MFE-I straw wattle captured 18.3% more of the introduced sediment than the NDOT standard due to the sod staples and staking increasing the impoundment potential of the installation. The straw wattle installations also captured 5.5% more of the introduced sediment on average than the excelsior wattle installations.



**Figure 3.36 Average Sediment Capture for Standard and Modified Sediment Barrier Installations**

### **3.6 Sediment Barrier Testing Summary**

Each of the four varieties of sediment barriers (i.e., silt fence, slash mulch berms, straw wattles, and excelsior wattles) tested through large-scale testing under simulated Nebraska highway construction conditions in the AU-SRF sediment barrier testing apparatus varied in performance. However, across all cases, the standard installations showed structural performance inefficiencies, such as silt fences being unable to be structurally sound under high impoundment conditions, slash mulch berms not facilitating impoundment with large amounts of material, and wattles undermining due to lack of ground contact, that could be improved upon with modifications. For each barrier, modifications were developed and tested under the same method to improve the structural performance of each, to ensure that they can perform adequately and without failure after experiencing numerous stormwater runoff events. From these modifications, the most feasible and effective installation was selected, and two more identical installations were tested.

Table 3.8 summarizes the MFE-I and its performance in sediment capture, impoundment, flow rate through the 30-min test period, and average water quality of the discharge for each of the four sediment barriers tested.

**Table 3.8: Sediment Barrier Testing Summary**

<b>Barrier</b>	<b>Modifications</b>	<b>Upstream Sediment Capture (%)</b>	<b>Max. Impoundment Depth (in. [cm])</b>	<b>Test Period Flow-through Rate (ft<sup>3</sup>/s [m<sup>3</sup>/s])</b>	<b>Average Discharge Turbidity (NTU)</b>	<b>Average Discharge TSS (mg/L)</b>
<b>Silt Fence</b>	Offset trench, dewatering board reduced post spacing	85.5	11.875 [30.16]	0.0034 [0.000096]	2,210	1,993
<b>Slash Mulch Berm</b>	Reduced profile, compacted in three lifts	73.5 (98.9 through entire installation)	4.875 [12.38]	0.0565 [0.0016]	1,181	782
<b>Straw Wattle</b>	Sod staples, increased joint overlap, non-destructive teepee staking at joints	80.8	7.0 [17.8]	0.063 [0.0018]	4,606	3,251
<b>Excelsior Wattle</b>	Same as Straw Wattle	75.3	4.0 [10.2]	0.062 [0.0018]	7,490	5,970

The silt fence installation facilitated the deepest impoundment of the barriers, as well as having the lowest average flow-through rate. Even with the dewatering board installed to allow impoundment to dewater, the clogging of the geotextile fabric led to impoundment being held behind the installation to fall out of suspension. Slash mulch berms facilitated less impoundment than both the silt fences and straw wattles; however, due to the three-dimensional nature and the increased length of the flow path of the installation, slash mulch berms were able to capture sediment within the installation, leading to it having the lowest discharge turbidity and TSS of all barriers, despite impounding less than the straw wattles and silt fence. The two varieties of wattles had the highest flow-through rate of all installations, with the excelsior wattle taking less time for the flow to pass through at the start of the simulated stormwater runoff event and dewatering faster than the straw wattle. Additionally, the excelsior wattle had the highest discharge turbidity and TSS of all sediment barrier MFE-I's.



## Chapter 4: Conclusions and Recommendations

### 4.1 Introduction

To protect water bodies and other natural areas from pollution due to sediment-laden runoff, the USEPA requires areas of earth-disturbing activity within 50 ft (15 m) of a water of the U.S. to either provide and maintain a 50 ft (15 m) natural, undisturbed vegetative buffer or provide sediment controls that provide equivalent or greater protection than a 50 ft (15 m) vegetated buffer (United States Environmental Protection Agency 2022). The research completed was divided into two research objectives associated with determining the sediment reduction capabilities of 50 ft (15 m) vegetated buffer and the performance of sediment barriers:

- (1) Develop a repeatable methodology to determine the sediment removal capabilities of various 50 ft (15 m) vegetated buffer configurations local to the state of Nebraska.
- (2) Evaluate standard and modified sediment barriers through large-scale laboratory testing under conditions commonly found on Nebraska DOT highway construction projects.

To reach these two research objectives, a research plan was completed that consisted of four tasks:

- (1) The completion of a literature review of past research on the sediment capture capabilities of vegetated buffers and performance testing of sediment barriers that were used to develop testing methodologies. The results of this literature review were used throughout the research project, including developing the vegetated buffer modeling methodology and determining potential sediment barrier modifications for large-scale performance evaluations.

- (2) Develop a repeatable methodology to evaluate the performance of a 50 ft (15 m) vegetated buffer; this modeling methodology used RUSLE2 and evaluated the sediment capture of over 11,000 buffer configurations.
- (3) Develop a large-scale testing methodology to evaluate sediment barrier performance based on simulated Nebraska highway conditions.
- (4) Using the large-scale sediment barrier performance evaluation methodology to assess the performance of standard silt fence, slash mulch berm, and wattle installations and develop and evaluate modifications that improve standard designs.

By reaching the research objectives through the accomplishment of the four tasks, this study provides valuable insight to the sediment removal capabilities of vegetated buffers and the performance of sediment barriers under simulated Nebraska highway construction conditions. These results also provide implementable guidance to the Nebraska DOT on improving the state of practice of sediment control, as well as generating repeatable methodologies for the performance evaluations of both vegetated buffer and sediment barriers.

#### **4.2 Sediment Removal Capabilities of Vegetated Buffers**

The first objective of this research was to develop a methodology that can determine the sediment removal capabilities of 50 ft (15 m) vegetated buffers. To complete this objective, a literature review was conducted on past testing and modeling of vegetated buffers and filter strips to determine pertinent factors in the performance of vegetated buffers in removing sediment from runoff that were to be used in developing a modeling methodology. Past testing indicated that factors relevant to sediment removal capabilities of vegetated buffers included the width of the buffer, the slope, the size distribution of both the soil in runoff and the soil the buffer is composed of, the vegetation type, and the amount of rainfall the area experienced. The

critical removal process found was sedimentation, or soil falling out of suspension. The slowing of flow aids sedimentation, so vegetated buffers that are more easily able to slow flow, such as ones with flatter slopes or denser vegetation, perform better in removing sediment from flow. Additionally, average soil particle size was found to be a pertinent factor in removal, with larger sediment able to be deposited easier within the vegetated buffers; smaller soil particles were only able to be removed from flow through infiltration.

Through a review of potential modeling equations and software, the U.S. Department of Agriculture's Revised Universal Soil Loss Equation<sup>2</sup> (RUSLE2) modeling software was chosen to evaluate the performance of vegetated buffers. RUSLE2 was chosen due to the extensive databases of soil types and vegetation present within the software, as well as its ability to calculate soil loss and sediment deposition rates across separate slopes (Foster et al. 2003). A profile of two slopes within RUSLE2, consisting of a 218 ft (66 m) upstream, bare construction site, and a 50 ft (15 m) vegetated buffer downstream, was generated that could be modified individually in slope, cover, location, and soil.

Factors common to Nebraska were chosen to analyze within RUSLE2, representative of all six of the landscape regions within the state that vary in climate, vegetation, soil type, and overall erosion risk. Nine of the most prevalent soil series, representative of 34.8% of the state, were used in the analysis. Three buffer slopes, four construction site slopes, six locations around the state for climate variation, and eighteen vegetation types consisting of six varieties of row crops and twelve types of grass or grass-like vegetation local to Nebraska were chosen to be used in modeling. Factors resulted in 11,664 unique vegetated buffer configurations evaluated through RUSLE2 for sediment capture capabilities.

Performance of vegetated buffers in removing suspended sediment varied widely, from as low as 18.46% to 99.48%, with a mean capture of 92.62%. However, 86.2% of buffers captured at least 90% of the sediment introduced from the upstream construction site. Larger soils, especially sands, were captured at a higher rate than other soil types, such as Silty Clay Loams and Silt Loams. Buffers with steeper slopes were less effective at capturing sediment, especially with certain vegetation types, such as row crops or red clover. Most of the grasses and grass-like vegetation performed similarly; the row crops, on average, especially soybeans and corn, captured less sediment. Modeling results tended to follow the trends found in the literature review; the factors found to decrease performance through large-scale testing also decreased sediment capture capabilities of modeled vegetated buffers.

To assist designers, contractors, and regulators in determining the sediment removal capabilities of specific vegetated buffers, a usable Microsoft® Excel® tool was developed that delivers the user the sediment loading, yield, and removal of a buffer with given conditions used in modeling. This tool can be useful to determine what sediment removal standards alternative sediment control practices will be required to reach.

Additionally, the vegetated buffer modeling methodology outlined in Chapter 2 can be replicated for other regions of the U.S. to determine the performance of vegetated buffers elsewhere. This modeling methodology and results can also be used to modify current vegetated buffer standards from the current, common “one-size-fits-all” standard of 50 ft (15 m), such as reducing or increasing the required length of buffers based on site specific conditions that can drastically affect the sediment removal capabilities.

Despite over 11,000 buffer configurations being modeled in this research, limitations exist, such as not every site-specific condition local to Nebraska being modeled. Additionally,

RUSLE2 makes multiple assumptions such as consistent slopes, vegetation coverage, and maintenance that might not be accurate to every construction project with a vegetated buffer; field conditions that could greatly affect the performance of vegetative buffers that were not analyzed in this modeling effort include irregular slopes, maintenance concerns, inconsistent vegetation coverage, and the presence of concentrated flows that are difficult for vegetation to remove sediment from than the sheet flow assumed in RUSLE2.

### **4.3 Performance Evaluation of Sediment Barriers**

To complete the second objective of this research, to determine the performance of sediment barrier practice employed by the Nebraska DOT, a large-scale testing methodology was developed. A review of past sediment barrier testing and monitoring indicated that small-scale testing and field monitoring can be helpful in evaluating the performance of specific components of sediment barrier installations and on-site performance and maintenance requirements. However, small-scale testing and field monitoring have limitations, such as not evaluating an entire installation or not being subject to consistent or known conditions. To fully evaluate entire sediment barrier installations under known and controlled conditions, large-scale testing must be conducted. Past large-scale sediment barrier testing has indicated that structural performance and the ability to repeatedly impound stormwater runoff are the most pertinent factors in the performance of sediment barriers.

To evaluate Nebraska DOT standard sediment barriers, the sediment barrier testing apparatus and methodology outlined in Bugg et al. were used (Bugg et al. 2017a). A theoretical flow and soil analysis over a representative drainage area with conditions local to Nebraska highway construction projects was completed to ensure testing accurately simulated Nebraska conditions. The peak 30-min of the average Nebraska 2-yr, 24-hr storm was used as an

introductory flow rate; the soil loss from that storm was determined from average Nebraska conditions using the Modified Universal Soil Loss Equation.

Testing of Nebraska DOT standards for three types of sediment barriers (silt fence, slash mulch berms, and wattles) presented opportunities for improvements to standard installations to improve structural performance; modifications were developed to improve the standard installations, including the development of the most feasible and effective installations for each sediment barrier type to provide recommendations to the Nebraska DOT for updated standard installations. Testing led to the following recommended installations that reduced the risk of common structural failures occurring:

- A silt fence installation with a 6 in. (15.2 cm) offset trench, reduced post spacing around areas of increased impoundment, and a dewatering board with overflow weir was developed that improved upon the structural inefficiencies shown in the testing of the standard of undermining, sagging of fabric, and impoundment not being able to properly dewater.
- Slash mulch berm installation with height and width reduced to 1.5 ft (0.46 m) and 3 ft (0.91 m) and with additional compaction was developed that facilitates more impoundment while using less material than the Nebraska DOT standard.
- A modified wattle installation with sod staples and teepee staking to facilitate ground contact and increase sediment capture capabilities.

Across all silt fence standard and modified installations tested, water quality results were compared between sampling locations and indicated that any water quality treatment in turbidity occurred was through sedimentation within the impoundment formed behind the installation and not filtration through the fabric. However, slash mulch berm installations had the lowest

discharge turbidity and TSS, on average, of all barriers tested and were also able to capture up to 98.9% of introduced sediment, with approximately 25% of that capture occurring within the berm itself.

All modifications developed through this research aimed to improve the structural capabilities of Nebraska DOT sediment barriers; other modifications likely exist that can further increase the performance capabilities of these sediment barriers that were not evaluated in this research. An additional limitation is that there were uncontrollable variations in the materials testing, including tested wattles varying widely in length, circumference, and density, silt fence fabric having imperfections at certain locations in the same roll of material, and slash mulch material varying widely within even the same stockpile. These inconsistencies could have affected testing results and caused variations in impoundment depths and water quality treatment between otherwise identical installations. Testing also did not evaluate the long-term capabilities of these barriers, which could potentially affect future performance, especially of slash mulch berms and wattles composed primarily of biodegradable materials.

The same testing methodology and apparatus used in this research can be used to test the performance of other varieties of common sediment barrier practices that have not yet been evaluated. Additionally, the flow and sediment introduction rates can be easily modified to test sediment barriers in other regions that have not had their common sediment barriers tested to improve the base of knowledge on sediment barrier performance.

#### **4.4 Implementation and Expected Benefits**

Modeling of vegetated buffers and testing NDOT standard and modified sediment barriers provides usable and implementable guidance to the NDOT and other regulatory agencies. The development of a repeatable modeling methodology for sediment capture of vegetated buffers

allows for the analysis of not only 50 ft (15 m) vegetated buffers but also shorter buffers that can be supplemented by sediment barriers to reach regulatory requirements.

The results of sediment barrier testing found that the adoption of the recommended MFE-I sediment barriers for silt fences, slash mulch berms, and wattles would increase the sediment capture capabilities of NDOT sediment barrier installations, improve downstream water quality, and prevent common structural failures. Increasing the sediment capture capabilities and improving discharge water quality helps protect impaired waterways and other natural environments in Nebraska. Decreasing the risk of structural failure of sediment barriers not only protects natural areas and waterways from uncontrolled sediment discharge after a structural failure of a sediment barrier, such as silt fences or wattles undermining, complete failure of a silt fence due to excessive impoundment, or slash mulch berm washout due to a lack of compaction, but also saves taxpayer funds by preventing the repeated replacement of sediment barrier installations on Nebraska highway construction projects.

#### **4.5 Recommendations for Future Research**

Through modeling of vegetated buffers and large-scale performance testing of sediment barrier installations, two of the three regulatory requirements for protecting WOTUS within 50 ft (15.2 m) of construction projects were analyzed: (1) providing and maintaining a 50 ft (15.2 m) undisturbed vegetated buffer or (2) providing sediment barriers with equivalent sediment load reduction as a 50 ft (15.2 m) vegetated buffer. However, the third option, supplementing a shorter vegetated buffer with a sediment barrier that together reaches the equivalent sediment control of a 50 ft (15.2 m) vegetated buffer, was not evaluated during the completion of this research. The modeling methodology outlined in Chapter 2 can be used with shorter vegetated buffers to determine the sediment capture capabilities of vegetated buffers of buffers shorter than



50 ft (15.2 m) to not only determine how they can be supplemented by installed sediment barriers but also determine if vegetated buffer regulations can be altered to allow for shorter vegetated buffers if conditions are favorable for sediment capture, such as low slopes, easily capturable soil, and advantageous vegetation density and species. The vegetated buffer modeling methodology can also be replicated on conditions in other regions of the country to generate more guidance on vegetated buffer performance in sediment capture.

The large-scale testing methodology outlined in Chapter 3 can be repeated using the AU-SRF sediment barrier testing apparatus on conditions local to other regions of the country and on other sediment barriers. Future testing can be conducted by adjusting flow and sediment introduction rates to represent conditions local to other areas of the United States to evaluate sediment barrier standards and develop most feasible and effective sediment barrier installations for other specific areas. Additionally, more sediment barrier practices can be evaluated for performance under Nebraska conditions in addition to the three practices tested, such as more innovative practices like sediment retention barriers using flocculants. More testing can also be conducted on installations with a dewatering board to optimize the dewatering process, such as changing the height and angle of the overflow weir or adjusting the size, number or spacing, of dewatering holes.

#### **4.6 Conclusions**

This research aimed to contribute to the body of knowledge on the performance of vegetated buffers and sediment barriers in capturing sediment on highway construction projects. The modeling methodology outlined in Chapter 2 is repeatable for other jurisdictions or regulatory bodies that wish to provide guidance on the sediment removal capabilities of 50 ft (15 m) vegetated buffers. The modeling methodology can also be used to evaluate buffers under 50 ft

(15 m) to assess if undersized buffers can be used to provide acceptable sediment controls under favorable conditions, such as shallower slopes and favorable soils. Additionally, contractors and designers within Nebraska can use the dataset generated using this methodology of 11,664 vegetated buffer configurations to select equivalent sediment controls to a local 50 ft (15 m) vegetated buffer. The testing completed on sediment barriers under Nebraska conditions aimed to fill a research gap of performance evaluations on sediment barrier conditions in regions outside of the Southeastern U.S., such as the Midwestern U.S. Modifications developed through testing of Nebraska DOT standard sediment barriers can be used to improve the state of practice in erosion and sediment control on highway construction projects in Nebraska. In all, this research can be applied to improve the erosion and sediment control industry in Nebraska and elsewhere, especially in meeting the regulatory requirement of maintaining a 50 ft (15 m) vegetated buffer or equivalent sediment controls.

#### **4.7 Acknowledgements**

This research is based on a study sponsored by the Nebraska Department of Transportation. The author greatly acknowledges the financial support.

## References

- Alabama Department of Environmental Management. 2021. *National Pollutant Discharge Elimination System General Permit*. Montgomery, AL.
- Alabama Soil and Water Conservation Committee. 2018. *Alabama Handbook for Erosion Control, Sediment Control and Stormwater Management on Construction Sites and Urban Areas Volume 1 Developing Plans and Designing Best Management Practices*. Montgomery, AL.
- Arora, K., S. K. Mickelson, and J. L. Baker. 2003. *Effectiveness of Vegetated Buffer Strips in Reducing Pesticide Transport in Simulated Runoff*.
- ASTM. "Standard Test Method for Determining Filtering Efficiency and Flow Rate of the Filtration Component of a Sediment Retention Device 1." West Conshohocken, PA, 2018a, <https://doi.org/10.1520/D5141-11R18>.
- ASTM. "Standard Test Method for Determination of Turbidity Above 1 Turbidity Unit (TU) in Static Mode 1." West Conshohocken, PA, 2018b  
<https://doi.org/10.1520/D7315-17>.
- ASTM. "Designation: D5907 – 18 Standard Test Methods for Filterable Matter (Total Dissolved Solids) and Nonfilterable Matter (Total Suspended Solids) in Water 1." West Conshohocken, PA, 2018c. <https://doi.org/10.1520/D5907-18>.
- ASTM. "Standard Test Method for Determination of Sediment Retention Device (SRD) Effectiveness in Sheet Flow Applications." West Conshohocken, PA, 2021.
- Barrett, M. E., J. F. Malina, and R. J. Charbeneau. 1998. "An evaluation of geotextiles for temporary sediment control." *Water Environment Research*, 70 (3): 283–290. Wiley.  
<https://doi.org/10.2175/106143098x124902>.

- Bugg, R. A., W. N. Donald, W. C. Zech, and M. A. Perez. 2017a. "Improvements in Standardized Testing for Evaluating Sediment Barrier Performance: Design of a Full-Scale Testing Apparatus." *Journal of Irrigation and Drainage Engineering*, 143 (8): 04017029. American Society of Civil Engineers (ASCE).  
[https://doi.org/10.1061/\(asce\)ir.1943-4774.0001194](https://doi.org/10.1061/(asce)ir.1943-4774.0001194).
- Bugg, R. A., W. Donald, W. Zech, and M. Perez. 2017b. "Performance evaluations of three silt fence practices using a full-scale testing apparatus." *Water (Switzerland)*, 9 (7). MDPI AG. <https://doi.org/10.3390/w9070502>.
- Burns, S. E., and C. F. Troxel. 2015. *Life Cycle Cost Assessment and Performance Evaluation of Sediment Control Technologies*.
- Clampitt, J. E., M. A. Perez, J. Blake Whitman, W. N. Donald, J. J. LaMondia, and A. J. Craig. 2023. "Hydraulic Evaluation of Wattle Encasement Materials." *Transportation Research Record: Journal of the Transportation Research Board*, 036119812311522. SAGE Publications. <https://doi.org/10.1177/03611981231152255>.
- Dunn, C. D., M. B. Stephenson, and J. Stubbendieck. 2016. *Common Grasses of Nebraska Rangeland Prairie Pasture (Including Grass-Like Plants)*.
- Foster, G. R., T. E. Toy, and K. G. Renard. 2003. *Comparison of the USLE, RUSLE1.06c, and RUSLE2 for Application to Highly Disturbed Lands*.
- Gogo-Abite, I., and M. Chopra. 2013. "Performance evaluation of two silt fence geotextiles using a tilting test-bed with simulated rainfall." *Geotextiles and Geomembranes*, 39: 30–38. <https://doi.org/10.1016/j.geotexmem.2013.07.001>.
- Henry, K. S., and S. T. Hunnewell. 1995. *Silt Fence Testing for Eagle River Flats Dredging*.

- Hui, T. K. 2010. *Best Management Practices on Soil Erosion and Sediment Control in the Construction Industry*.
- Kaufman, M. M. 2000. "Erosion control at construction sites: The science-policy gap." *Environ Manage*, 26 (1): 89–97. Springer-Verlag New York.  
<https://doi.org/10.1007/s002670010073>.
- Kazaz, B., J. C. Schussler, L. C. Dickey, and M. A. Perez. 2022. "Soil Loss Risk Analysis for Construction Activities." *Transportation Research Record: Journal of the Transportation Research Board*, 036119812210750.  
<https://doi.org/10.1177/03611981221075027>.
- Kincl, D., D. Kabelka, D. Heřmanovská, J. Vopravil, R. Urban, and T. Křemen. 2022. "Evaluation of sediment barriers in relation to the trap of soil particles." *Soil and Water Research*, 17 (No. 4): 201–210. Czech Academy of Agricultural Sciences.  
<https://doi.org/10.17221/48/2022-swr>.
- Liu, L., M. A. Perez, J. B. Whitman, W. N. Donald, and W. C. Zech. 2021. "SILTspread: Performance-Based Approach for the Design and Installation of Silt Fence Sediment Barriers." *Journal of Irrigation and Drainage Engineering*, 147 (10). American Society of Civil Engineers (ASCE). [https://doi.org/10.1061/\(asce\)ir.1943-4774.0001608](https://doi.org/10.1061/(asce)ir.1943-4774.0001608).
- Liu, X., X. Zhang, and M. Zhang. 2008. "Major Factors Influencing the Efficacy of Vegetated Buffers on Sediment Trapping: A Review and Analysis." *J Environ Qual*, 37 (5): 1667–1674. Wiley. <https://doi.org/10.2134/jeq2007.0437>.
- Mahler, B. J. 2018. "Sediment-Associated Contaminants." *US Geological Survey: Water Resource Mission Area*.

- Nebraska Department of Transportation. *Standard Specifications for Highway Construction 2017 Edition*. Lincoln, NE, 2017.
- Nebraska Department of Transportation. *Standard Plans*. Lincoln, NE, 2021a.
- Nebraska Department of Transportation. *Special Plans*. Lincoln, NE, 2021b.
- Nebraska Department of Transportation. “Approved Products List.” Lincoln, NE, 2022.
- Nebraska Department of Transportation. *Construction Stormwater: Best Management Practices*. Lincoln, NE, 2021.
- Perez, M. A., W. C. Zech, W. N. Donald, and X. Fang. 2016. “Design Methodology for the Selection of Temporary Erosion and Sediment Control Practices Based on Regional Hydrological Conditions.” *J Hydrol Eng*, 21 (4). American Society of Civil Engineers (ASCE). [https://doi.org/10.1061/\(asce\)he.1943-5584.0001328](https://doi.org/10.1061/(asce)he.1943-5584.0001328).
- Ramesh, R., L. Kalin, M. Hantush, and A. Chaudhary. 2021. “A secondary assessment of sediment trapping effectiveness by vegetated buffers.” *Ecol Eng*, 159. Elsevier B.V. <https://doi.org/10.1016/j.ecoleng.2020.106094>.
- Renard, K. G., G. R. Foster, G. A. Weesies, D. K. McCool, and D. C. Yoder. 1997. “Predicting Soil Erosion by Water: A Guide to Conservation Planning with the Revised Universal Soil Loss Equation (RUSLE).” *Agricultural Handbook Number 703*.
- Schneider, S. 2021. *Authorization to Discharge Under the National Pollutant Discharge Elimination System (NPDES) General NPDES Permit Number NER210000 for Storm Water Discharges from Construction Sites to Waters of the State of Nebraska*. Lincoln, NE.

- Schussler, J., M. A. Perez, B. Cetin, and J. B. Whitman. 2020. *Field Monitoring of Erosion and Sediment Control Practices and Development of Additional Iowa DOT Design Manual Guidance Final Report Sponsored by Federal Highway Administration Iowa Department of Transportation (InTrans Project 18-654)*.
- State of North Carolina Department of Environmental Quality Division of Energy, M. and L. R. 2019. "General Permit To Discharge Stormwater Under the National Pollutant Discharge Elimination System for: Construction Activities that are also Subject to the North Carolina Sedimentation Pollution Control Act of 1973."
- Storey, B. J., M.-H. Li, J. A. Mcfalls, and Y.-J. Yi. 2009. *Stormwater Treatment with Vegetated Buffers*.
- Thompson, A., A. Krohn, R. Poe, C. Veys, and C. Wienhold. *Plan for the Roadside Environment*. Lincoln, NE, 2008.
- United States Department of Agriculture. 2022. "2021 State Agricultural Overview Nebraska."
- United States Environmental Protection Agency. 2022. *2022 Construction General Permit (CGP) (as modified) National Pollutant Discharge Elimination System General Permit for Discharges from Construction Activities (as modified)*. Washington, D.C.
- "USA Mean Rainfall." 2013.  
<https://www.arcgis.com/home/item.html?id=5fb02ca0d75843b083781beb8a05ca19>.
- USD. "Overview of RUSLE2." Oxford, MS. 2016.
- USDA. 2022. "Web Soil Survey." Accessed July 12, 2022.  
<https://websoilsurvey.sc.egov.usda.gov/App/HomePage.htm>.
- USEPA.. *Silt Fences*. Washington, D.C. 2021a.

- USEPA. *Stormwater Best Management Practice Straw or Hay Bales Minimum Measure: Construction Site Stormwater Runoff Control Subcategory: Sediment Control*. Washington, D.C., 2021b.
- Weiss, P. T., A. J. Erickson, J. S. Gulliver, and R. M. Hozalski. 2013. "Stormwater Treatment: Assessment and Maintenance." *St. Anthony Falls Laboratory*.
- Whitman, J. B. 2022. "Improving the Design and Performance of Double-Row Sediment Barriers Used During Highway Construction." *Transportation Research Record: Journal of the Transportation Research Board*, 036119812211418. SAGE Publications. <https://doi.org/10.1177/03611981221141899>.
- Whitman, J. B., M. A. Perez, W. C. Zech, and W. N. Donald. 2021a. "Practical Silt Fence Design Enhancements for Effective Dewatering and Stability." *Journal of Irrigation and Drainage Engineering*, 147 (1). American Society of Civil Engineers (ASCE). [https://doi.org/10.1061/\(asce\)ir.1943-4774.0001521](https://doi.org/10.1061/(asce)ir.1943-4774.0001521).
- Whitman, J. B., J. C. Schussler, M. A. Perez, and L. Liu. 2021b. "Hydraulic Performance Evaluation of Wattles Used for Erosion and Sediment Control." [https://doi.org/10.1061/\(ASCE\)IR.1943](https://doi.org/10.1061/(ASCE)IR.1943).
- Whitman, J. B., W. C. Zech, and W. N. Donald. 2019a. "Full-Scale Performance Evaluations of Innovative and Manufactured Sediment Barrier Practices." *Transp Res Rec*, 2673 (8): 284–297. SAGE Publications Ltd. <https://doi.org/10.1177/0361198119827905>.
- Whitman, J. B., W. C. Zech, and W. N. Donald. 2019b. "Improvements in small-scale standardized testing of geotextiles used in silt fence applications." *Geotextiles and*



- Geomembranes*, 47 (5): 598–609. Elsevier Ltd.  
<https://doi.org/10.1016/j.geotexmem.2019.04.002>.
- Whitman, J. B., W. C. Zech, W. N. Donald, and J. J. LaMondia. 2018a. “Full-Scale Performance Evaluations of Various Wire-Backed Nonwoven Silt Fence Installation Configurations.” *Transp Res Rec*, 2672 (39): 68–78. SAGE Publications Ltd.  
<https://doi.org/10.1177/0361198118758029>.
- Whitman, J. B., W. Zech, and W. Donald. 2018b. *FINAL COMPREHENSIVE REPORT Evaluation of Sediment Barrier Practices using Large-Scale Testing Techniques*.
- Wyant, D. C. 1980. *Evaluation of Filter Fabrics for use as Silt Fences*. Charlottesville, Virginia.
- Xiao, H., G. Liu, P. Liu, F. Zheng, J. Zhang, and F. Hu. 2017. “Sediment transport capacity of concentrated flows on steep loessial slope with erodible beds.” *Sci Rep*, 7 (1). Nature Publishing Group. <https://doi.org/10.1038/s41598-017-02565-8>.
- Yuan, Y., R. L. Bingner, and M. A. Locke. 2009. “A review of effectiveness of vegetative buffers on sediment trapping in agricultural areas.” *Ecohydrology*, 2 (3): 321–336.  
<https://doi.org/10.1002/eco.82>.
- Zech, W. C., J. S. McDonald, and T. P. Clement. 2009. “Field Evaluation of Silt Fence Tieback Systems at a Highway Construction Site.” <https://doi.org/10.1061/ASCE1084-0680200914:3105>.
- Zhang, X., X. Liu, M. Zhang, R. A. Dahlgren, and M. Eitzel. 2010. “A Review of Vegetated Buffers and a Meta-analysis of Their Mitigation Efficacy in Reducing Nonpoint Source Pollution.” *J Environ Qual*, 39 (1): 76–84. Wiley.  
<https://doi.org/10.2134/jeq2008.0496>.

## **Appendix A: Alabama Power Slash Mulch Berm Testing Final Report**

### **Overview**

Sediment barriers are practices commonly placed around the perimeter of active construction sites to prevent sediment-laden discharge from polluting nearby waters. Examples of common sediment barrier practices include: silt fences and wattles. Sediment capture through a sediment barrier is achieved primarily by impounding runoff and reducing flow velocity, which facilitates the gravitational settlement of suspended soil particles. Research has shown that only a small fraction of sediment is removed by filtration through the sediment barrier; much less than what is captured through sedimentation (Barrett et al. 1998). Under controlled testing, Alabama Department of Transportation (ALDOT) silt fence sediment barriers have been shown to capture an average of 93% of sediment introduced into the system (Whitman et al. 2018). Other sediment barriers such as straw wattles, compost logs, and excelsior blocks were able to capture over 80% of sediment introduced (Whitman et al. 2019).

One less common sediment barrier practice that is growing in use is a slash mulch berm. Slash mulch is a material by-product created by shredding and chipping timber that has been removed during land clearing. Slash mulch can be arranged into berms to serve as a natural biodegradable sediment barrier. Not only are slash mulch berms biodegradable, but they also have the advantage of utilizing materials that would otherwise be burned or hauled off site and landfilled. Additionally, as the slash mulch berm breaks down, carbon is sequestered in the soil on-site. Multiple regulatory bodies, including the Georgia Soil and Water Conservation Commission (GSWCC) and the Minnesota Department of Transportation (MnDOT), have approved slash mulch berms as a viable sediment barrier practice (GSWCC 2016, MnDOT 2020). Slash mulch berms are typically arranged in a trapezoid cross-section, ranging from 2 to 4 ft (0.61 to 1.22 m) high and from 5 to 8 ft (1.52 to 2.44 m) wide. (MnDOT 2020). Alabama Power has started using slash mulch berms on their construction sites in lieu of traditional sediment barriers (e.g., silt fences). The Alabama Power berms are constructed using bulldozers and can be as large as 4 ft by 8 ft (1.22 m by 2.44 m). Figure 1 shows field images of a slash mulch berm, taken on an Alabama Power construction project, installed to prevent sediment from passing beyond the practice and discharging offsite. Despite field observations indicating the possibility of a slash mulch berm serving as an effective sediment barrier practice, there has been little research on determining their effectiveness.

This report summarizes the findings from large-scale testing of slash mulch berms performed at the Auburn University- Stormwater Research Facility (AU-SRF). Three triplicate installations were tested, each with three back-to-back, identical simulated stormwater runoff events. All tested installations showed an improvement in water quality, with downstream turbidity and total suspended solids (TSS) on average decreasing by 78.5% and 83.9%, respectively, compared to upstream introduced water. Additionally, up to 88% of sediment was retained upstream of the barrier by weight. This report provides details and findings of performance testing.



(a) installed slash mulch berm



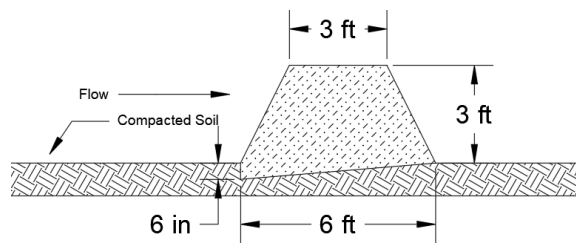
(b) sedimentation upstream of berm

**Figure 1: Field installation of slash mulch berm (photos courtesy of Cliff Young).**

## Methodology

To determine the effectiveness of a slash mulch berm as a sediment barrier practice using large-scale testing, a modified ASTM D7351 testing apparatus was employed (ASTM 2021). This sediment barrier testing apparatus contains a water and soil introduction area, a 3H:1V impervious slope to facilitate sheet-flow, a 12 ft (3.66 m) long by 20 ft (6.10 m) wide earthen area, and a downstream catch basin. The catch basin is 10 ft (3.05 m) wide, 6 ft (1.83 m) long, and 4.67 ft (1.42 m) deep, leading to a volume of 280 ft<sup>3</sup> (7.93 m<sup>3</sup>). The construction and specifications of the test apparatus are fully described in *Improvements in Standardized Testing for Evaluating Sediment Barrier Performance: Design of a Full-Scale Testing Apparatus* (Bugg et al. 2017).

Using this testing apparatus, 20 ft (6.10 m) long slash mulch berms were installed in a trapezoidal configuration measuring 3 ft (0.9 m) tall and 6 ft (1.8 m) wide along the base. The berms were configured to a 1:2 H:V side slope configuration, with a 3 ft (0.9 m) top width. The installation includes a 6 in. (0.15 m) deep triangular key along the front face of the berm. Figure 2(a) depicts a schematic of the installation. The berms were installed in three lifts, each approximately 1 ft (0.3 m) tall to allow compaction with the bucket of a Bobcat® E35 mini-excavator. Figure 2(b) shows the installed berm in the testing apparatus.



(a) installation schematic



(b) initial installation, pre-test photo

**Figure 2: Slash Mulch Berm Installation in AU-SRF Sediment Barrier Testing Apparatus.**

The first berm installed in the testing apparatus was situated along the midspan within the earthen section of the testing apparatus. Subsequent slash mulch berm installations were installed at the downstream end of the testing area, to better quantify the amount of sedimentation upstream.; however, after the first installation, the mulch berm was installed at the downstream end of the testing area. Additionally, a sheet of 3-mil polyethylene plastic sheeting was installed between the berm and the earthen test section, to allow for the deposited soil to be collected and weighed following experiments, as shown in Figure 3. Also, for the final installation, all run-off was captured in the collection basin and treated with flocculant that had previously been matched with the soil type, to allow for the suspended soil to rapidly settle out of suspension and then be removed and measured after testing (Kazaz et al. 2022). To estimate the amount of sediment that is able to pass through the barrier, the sediment that is in the bottom of the collection tank was collected, along with water samples of the discharge from the collection tank to quantify the sediment that was unable to fully fall out of suspension.



**Figure 3: Updated Slash Mulch Berm Installation, Offset from Toe of Slope**

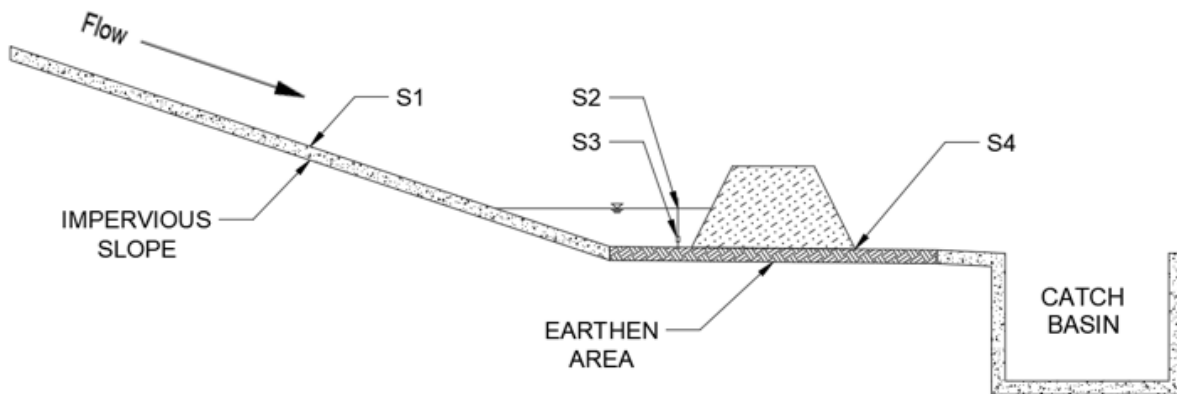
The installed slash mulch berms were evaluated using a flow rate of 0.2 ft<sup>3</sup>/s (0.0062 m<sup>3</sup>/s) and sediment introduction rate of 37.6 lb/min (17.6 kg/min) resulting in an influent concentration of 3.1 lb/ft<sup>3</sup> (50,000 mg/L). This loading is designed to mimic the peak 30-minutes of a 2-yr, 24-hr storm in Alabama and representative of expected sediment loading from a construction site. The sediment introduction rate and water flow rate for this simulated stormwater runoff event were calculated using conditions typical to the state of Alabama using the U.S. Dept. of Agriculture's Urban Hydrology for Small Watersheds (TR-55) and the Modified Universal Soil Loss Equation (MUSLE) (USDA 1986, Bugg et al. 2017).

Sediment-laden flow was introduced into the test apparatus at a consistent rate for a period of 30 minutes. After flow introduction was completed, pumps were shut off and the impoundment caused by the berm was allowed to dewater, revealing a pattern of deposited sediment. The impoundment caused by the berm can be seen in Figure 4(a). Sedimentation upstream of the berm can be seen in Figure 4(b). To test the longevity of the practices, the berm was subjected to three back-to-back cycles of sediment-laden flow introduction. This testing approach mimics multiple runoff events and can provide guidance on how the practice performs from a longevity standpoint.



**Figure 4: Slash Mulch Berm Testing.**

During each simulated runoff event, water samples were taken at the four locations shown in Figure 5: upstream of the berm on the impervious slope (S1), the top surface of the impoundment created by the berm (S2), the bottom of the impoundment using a submersible pump (S3), and directly downstream of the berm (S4). These grab samples were 8.0 oz. (240 mL) in volume and were taken at five-minute intervals during the test and for the first 15 minutes of the dewatering period, with the intervals increasing as the dewatering period continued beyond the 45-minute mark. These samples were analyzed in the AU-SRF water quality lab for turbidity (ASTM D7315) and total suspended solids (TSS) (ASTM D5907).



**Figure 5: Grab Sample Locations**

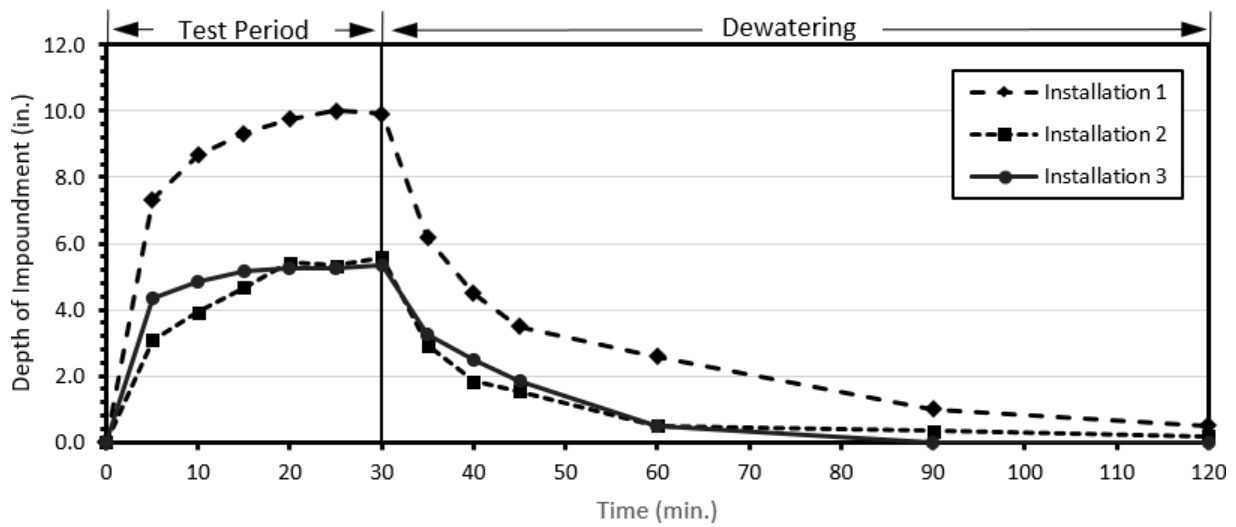
Impoundment depth and length were measured and recorded at the same grab sample intervals, to quantify the impoundment created by the berm. Additionally, to estimate the flow-rate through the berm and into the catch basin at the downstream end of the testing apparatus, a Solinst Levellogger was employed to record the depth of water in the catch basin at 15-second intervals. Using the difference in water height between each interval and the known dimensions of the rectangular catch basin, an approximate flow through rate was calculated. The time after the start of flow introduction that discharge passed through the practice and into the catch basin downstream of the testing area was also recorded. Additionally, the time when the catch basin overtopped was recorded.

## **Results**

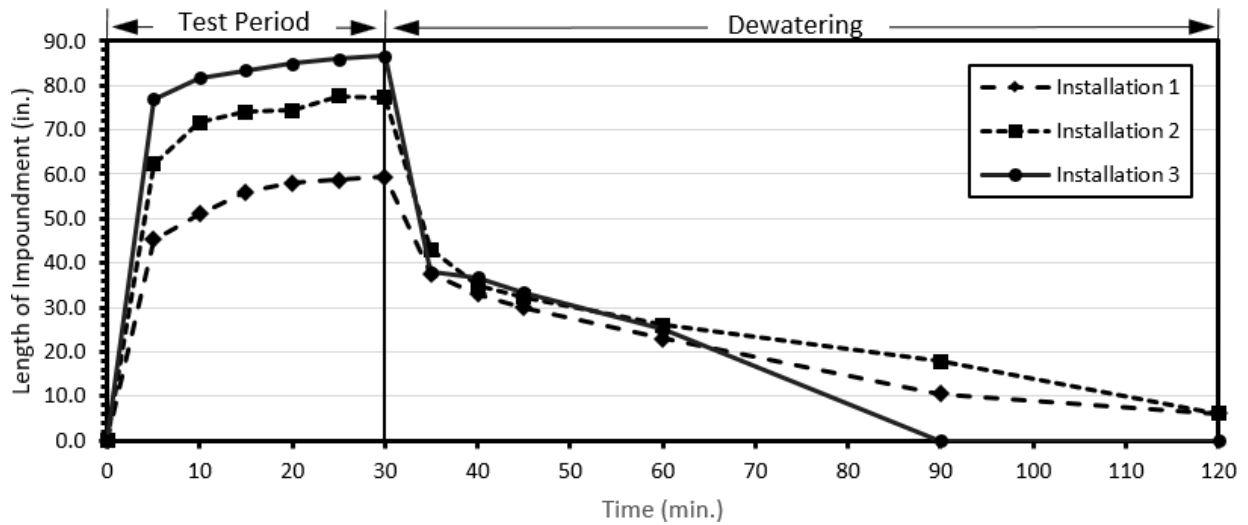
This section of the report highlights key findings during testing performed on installations of the slash mulch berm sediment barrier.

### ***Impoundment***

In Figure 6, the average depth and length of the pool of water created by the installed slash mulch berm is shown with respect to the time from the start of each test in the series. The data is different for the first installation due to the berm being moved to the downstream end of the test bed for all subsequent installations, allowing for a longer and shallower impoundment of approximately the same volume. The datasets followed the same pattern, with a sudden rise in impoundment volume at the start of flow introduction and reaching close to a steady-state maximum impoundment after approximately 20 minutes into the start of the test period. The dewatering process took a minimum of 60 minutes after the end of flow introduction. Maximum impoundment depth was approximately 10 in. (0.25 m) for the first installation and approximately 6 in. (0.15 m) for the second and final installations. Maximum impoundment length varied, due to different install locations in the earthen test bed, and had a maximum of just over 5.5 ft. (1.68 m) for the first installation and approximately 8.5 ft. (2.3 m) for the second and final installations.



(a) Depth of Impoundment



**Figure 6: Impoundment Depth and Length.**

Past performance testing on silt fences and other sediment barrier practices found that when a practice is able to create an upstream impoundment depth of at least 12 in. (0.30 m), sediment capture is consistently above 90% (Whitman et al. 2019). Once impoundment reaches a depth of 18 in. (0.46 m), any additional impoundment does not substantially improve sediment capture (Whitman et al. 2019). This data shows that the impoundment caused by a slash mulch berm does not reach the levels required to maximize capture through the process of sedimentation. Opportunities exist to optimize the installation of slash mulch berms to encourage further impoundment of runoff.

### ***Flow into Collection Tank***

Measured flow data across the three installations is shown in Table 1. Each subsequent simulated runoff event, on average, had a shorter time from the start of flow introduction to the first discharge into the collection tank downstream. Overtopping of the collection tank typically occurred either shortly after or just before the end of flow introduction. The flow-through-rate was calculated using Levellogger data and the dimensions of the catch basin. To compare to past testing, it is noted on a linear ft (m) basis. The slash mulch berm had an average flow-through rate of 0.008 ft<sup>3</sup>/s per ft (0.00074 m<sup>3</sup>/s per m). This flow rate is 20% less than the introduced flow-through rate into the testing apparatus of 0.010 ft<sup>3</sup>/s per ft (0.00093 m<sup>3</sup>/s per m), indicating that there was attenuation of flow caused by the slash mulch berm.

**Table 1: Flow Data by Runoff Event**

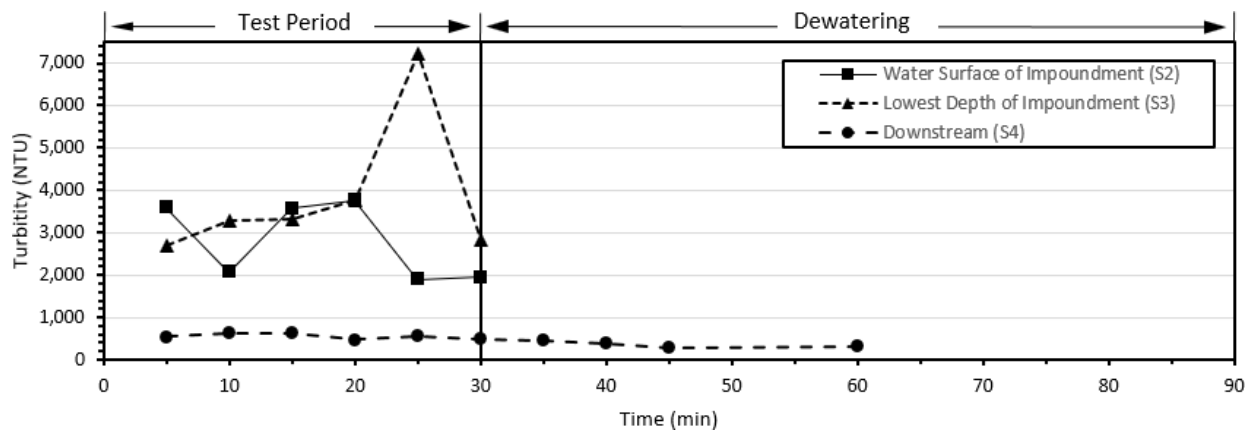
Runoff Event	Time of First Discharge into Catch Basin (mm:ss)	Flow-through Rate ft <sup>3</sup> /s per ft (m <sup>3</sup> /s per m)
Test 1	4:30	0.007 (0.00065)
Test 2	2:56	0.009 (0.00084)
Test 3	2:25	0.008 (0.00074)
Average	3:17	0.008 (0.00074)

Comparing to existing data sets, the flow-through-rate for the slash mulch berms is higher than manufactured silt fence systems which average 0.006 ft<sup>3</sup>/s per ft (0.00056 m<sup>3</sup>/s per m). The flow-through-rate of the slash mulch berm is similar to that of straw wattles, compost logs, and excelsior blocks, all of which average between 0.009 and 0.010 ft<sup>3</sup>/s per ft (0.00084 and 0.00093 m<sup>3</sup>/s per m) (Whitman et al. 2019).

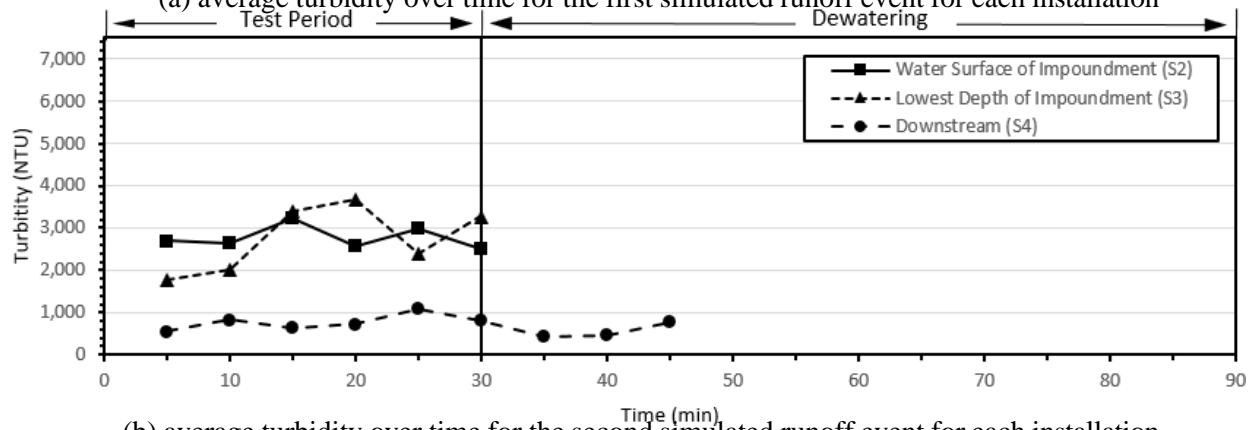
### ***Turbidity***

Turbidity data for each simulated stormwater runoff event in each series and the average of each are shown in Figure 7, Figure 8, and Table 2. Sampling on the impervious slope upstream of the installed practice indicated that the influent turbidity averaged about 15,000 NTU. The turbidity at the downstream of the barrier was typically less than the turbidity at any place in the impoundment created by the barrier, indicating that sediment capture also occurred as the sediment-laden stormwater passed through the barrier. Water quality data from samples collected at the impoundment and downstream showed improvement when compared to influent flow.

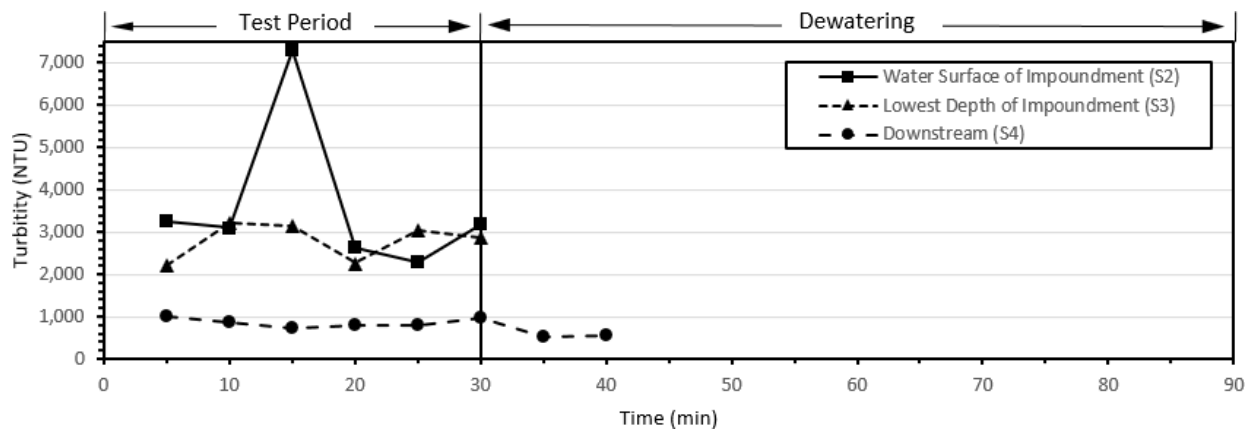




(a) average turbidity over time for the first simulated runoff event for each installation

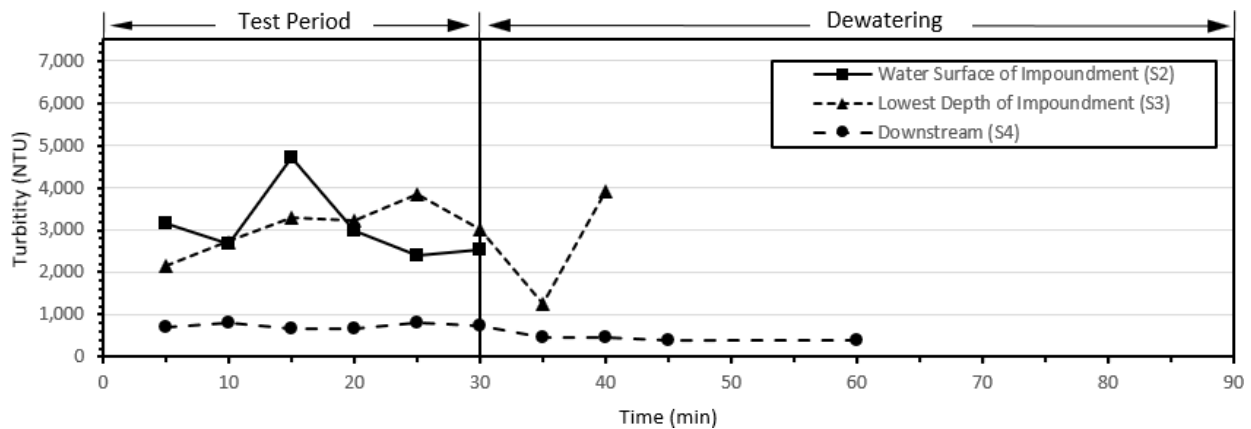


(b) average turbidity over time for the second simulated runoff event for each installation



(c) average turbidity over time for the third simulated runoff event for each installation

**Figure 7: Turbidity over Time by Runoff Event.**



Note: Averages were only calculated for sampling times with multiple water samples

**Figure 8: Average Turbidity across all Three Installations.**

Downstream sampling across all testing resulted in lower turbidity values. Sampling was not available at all sampling intervals due to lack of flow late in the dewatering process. Less samples were available later in the dewatering process for each subsequent simulated runoff event, due to lack of flow and impoundment.

**Table 2: Average Turbidity Data by Runoff Event**

Runoff Event	Turbidity at S2 (NTU)	Turbidity at S3 (mg/L)	Turbidity at S4 (mg/L)	$\Delta$ S2 vs. S3	$\Delta$ S3 vs. S4	Ratio, S2 vs. S4
Test 1	2,585	3,855	473	49.1%	87.7%	5.5
Test 2	2,821	2,759	695	-2.2%	74.8%	4.0
Test 3	2,916	2,792	780	-4.2%	72.0%	3.7
Average	2,887	2,929	631	1.5%	78.5%	4.6

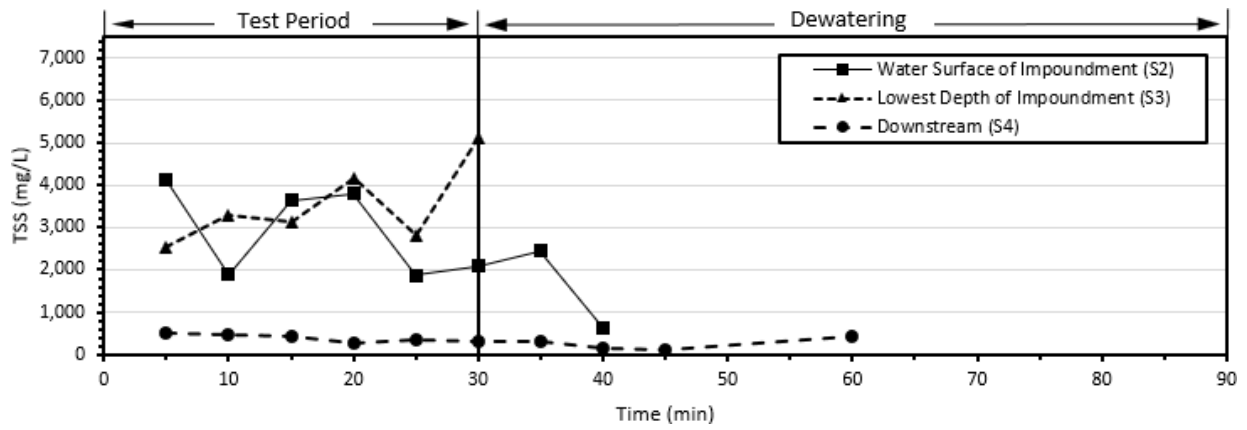
As presented in Table 2, on average, the turbidity downstream of the barrier increased with each subsequent simulated runoff event, with the percent difference of turbidity between the bottom of the impounded water and downstream discharge, as well as the ratio between the top of the impoundment and downstream discharge, dropping with each subsequent storm event on average over the three installations. Past sediment barrier testing has shown turbidity at the top of the impoundment is typically lower than the turbidity at the bottom of the impoundment; however, this did not seem to consistently occur in slash mulch berm testing. This is likely due to the insufficient impoundment depth created upstream of the installation when compared to other types of sediment barrier installations that have been previously tested.

Prior testing has shown that the turbidity downstream of a manufactured silt fence barrier was, on average, statistically insignificant or even higher than the turbidity at the top of the impoundment formed (Whitman et al. 2019). However, this was not the case in this testing, with the downstream samples (S4) having a turbidity 4.6 times lower on average than at the water surface upstream of the barrier (S2) on average. Additionally, a 78.5% reduction in turbidity was measured between the bottom of the impoundment (S3) and downstream of the slash mulch berm (S4). This

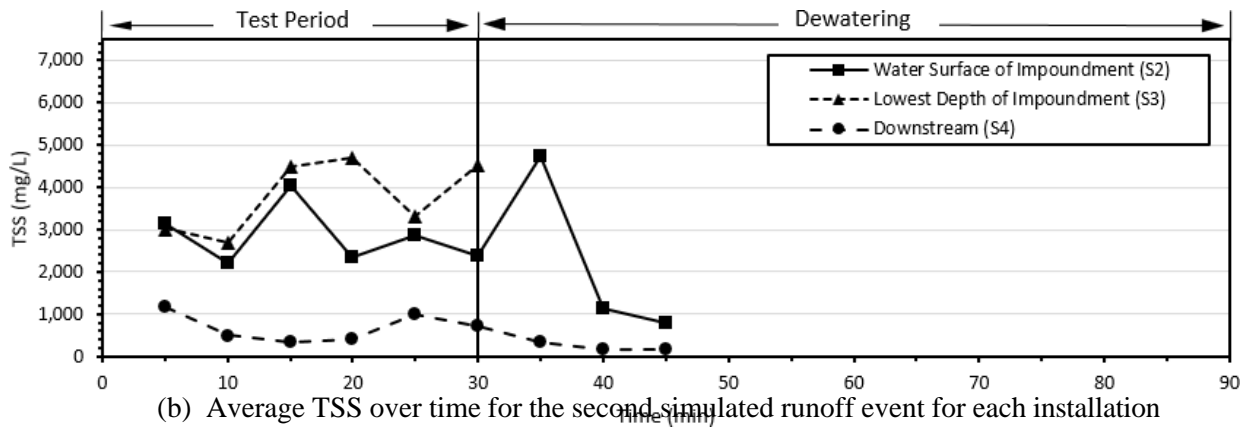
turbidity reduction was greater than the 56% reduction reported in silt fence testing (Whitman et al. 2018). The turbidity of the downstream flow that discharged through the slash mulch berm was comparable to other sediment barriers tested, including silt fences, with all being under 1,000 NTU on average; however, more flow, 33% more than the silt fence systems on average, was discharged through the installation (Whitman et al. 2018).

### ***Total Suspended Solids***

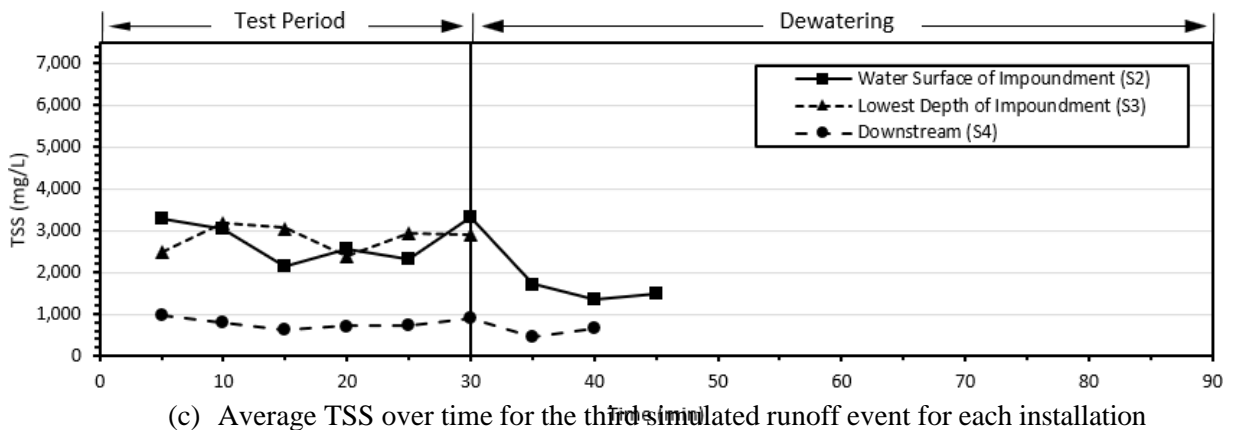
Total Suspended Solids (TSS) data is shown below in Figure 9, Figure 10, and Table 3. The water samples taken from the impervious slope, representing the influent water quality, ranged from 6,000 mg/L to as high as 97,000 mg/L. The data shown in the graphs follows a similar pattern as the turbidity data in collected water samples. The TSS in samples collected at the bottom of the impoundment (S3) were only 1.5% lower than samples collected at the top of the impoundment (S2). However, samples downstream (S4) of the slash mulch berm had less suspended solids than samples at the top or bottom of the impoundment upstream of the slash mulch berm, with an average reduction of 83.9% from the bottom of the impoundment to downstream of the slash mulch berm. This data suggests that sediment capture within the slash mulch berm (filtration) and sedimentation both have a role in the reduction of TSS caused by the slash mulch berm installation, due to downstream samples having a lower concentration than anywhere in the impoundment. It is important to note that with each subsequent simulated stormwater runoff event, higher TSS values were observed across all locations than in prior events.



(a) Average TSS over time for the first simulated runoff event for each installation

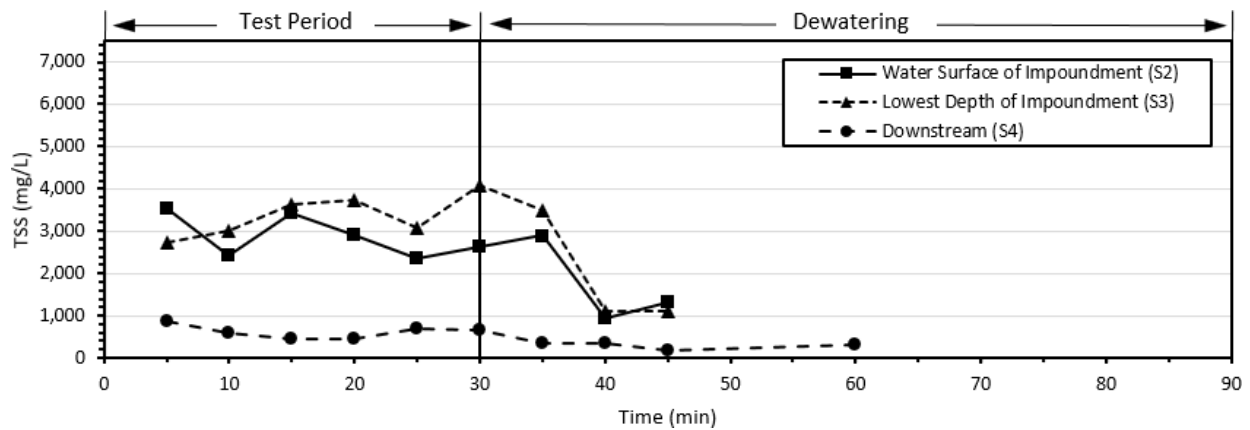


(b) Average TSS over time for the second simulated runoff event for each installation



(c) Average TSS over time for the third simulated runoff event for each installation

**Figure 9: TSS over Time.**



Note: Averages were only calculated for sampling times with multiple water samples

**Figure 10: Average TSS over Three Tests.**

**Table 3: Average TSS Data by Simulated Runoff Event**

Runoff Event	TSS at S2 (mg/L)	TSS at S3 (mg/L)	TSS at S4 (mg/L)	Δ S2 vs. S3	Δ S3 vs. S4
Test 1	1,646	2,458	598	49.3%	75.7%
Test 2	2,844	2,772	260	-2.5%	90.6%
Test 3	4,378	4,297	650	-1.9%	84.9%
Average	2,676	3,226	521	20.6%	83.9%

### Sediment Retention

For the final installation, sediment deposited on the upstream face of the installation was collected, dried, weighed, and compared to weight of introduced soil. The same was done for soil that was collected downstream of the slash mulch berm barrier within the catch basin. The data is shown in Table 4.

**Table 4: Captured Sediment Data for Final Installation**

Dry Weight of Soil Introduced lb (kg)	Dry Weight of Soil Retained Upstream lb (kg)	Percent Retained Upstream	Dry Weight of Soil Captured Downstream lb (kg)	Percent Captured Downstream
3,209 (1,456)	2,838 (1,287)	88.4%	57.5 (26.1)	1.8%

Based on the captured sediment data, slash mulch berms have a sediment retention of up to 98%, by weight with 88% of that capture occurring upstream of the barrier. The weight of the collected sediment downstream was added to the estimated soil still in suspension, which was found by calculating the Total Suspended Solids from water samples taken from the catch basin. Using the percent captured upstream and downstream, there is an estimated 9.8% of the introduced sediment that is captured within the berm.

The 98% sediment retention that was found by collecting the sediment upstream and downstream of the berm, was comparable to silt fences that had been previously tested. Non-woven silt fences that did not overtop, undermine, or have structural failures were found to retain on average 95% of sediment introduced (by volume), with most of this being retained upstream (Whitman et al. 2018). Straw wattles, compost logs, and excelsior blocks averaged 82%, 80%, and 84% sediment capture by volume, respectively (Whitman et al. 2019).

## **Conclusion**

This document summarizes findings from three slash mulch berm sediment barrier installations. Results from this testing indicated there was a water quality improvement in downstream samples compared to the influent flow. TSS from the impoundment compared to downstream samples had an average reduction of 83.9%. Turbidity was reduced by an average of 78.5% when comparing the impoundment water samples and the discharge samples. Data suggested that both sedimentation and filtration through the berm provided sediment capture. The installation had a maximum impoundment depth of approximately 10 in. (0.25 m), less than the 18 in. (0.46 m) required to maximize sedimentation effectiveness (Whitman et al. 2019). However, analysis of captured soil upstream and downstream of the barrier on the final installation indicated an overall sediment capture of 98%, with 88% of that capture being upstream of the barrier and about 10% of the capture occurring within the berm. Despite the slash mulch berm installation not achieving the full impoundment capabilities of previously tested non-woven silt fences, the effluent of downstream samples were found to be comparable to tested silt fences. Silt fences had an average discharge turbidity of approximately 1,000 NTU (Whitman et al. 2018), while the slash mulch berm resulted in an effluent turbidity of 631 NTU.

Measured TSS and turbidity values of water samples taken from the third simulated stormwater runoff event for each installation displayed poorer water quality than the first and second events. The turbidity on average for samples taken during the third event were 65% higher than those from the first event; the TSS on average was 120% higher for the third event. This indicates that regular maintenance and sediment removal is important to prevent resuspension of material previously captured upstream of the berm.

## References

- ASTM International. (2018). "Standard test method for determination of turbidity above 1 Turbidity Units (TU) in Static Mode" *ASTM D7315 - 17*, West Conshohocken, PA.
- ASTM International. (2021). "Standard test method for determination sediment retention device (SRD) effectiveness in sheet flow application" *ASTM D7315 - 17*, West Conshohocken, PA.
- ASTM International. (2018). "Standard test method for filterable matter (Total Dissolved Solids) and Nonfilterable Matter (Total Suspended Solids) in water." *ASTM D5907 - 18*, West Conshohocken, PA.
- Barrett, M. E., Malina, J. F., Jr., and Charbeneau, R. J. (1998). "An Evaluation of Geotextiles for Temporary Sediment Control." *Water Environment Research*, Vol. 70, No. 3, 283-290.
- Whitman, J. B., W. C. Zech, and W. N. Donald. (2018). "Final Comprehensive Report: Evaluation of Sediment Barrier Practices using Large-Scale Testing Techniques" *Highway Research Center*
- Bugg, R. A., W. N. Donald, W. C. Zech, and M. A. Perez. (2017). "Improvements in Standardized Testing for Evaluating Sediment Barrier Performance: Design of a Full- Scale Testing Apparatus." *J. Irrig. Drain Eng.*, Volume 143, No. 8.
- Georgia Soil and Water Conservation Commission (GSWCC). (2016). "Manual for Erosion and Sediment Control in Georgia." Athens, GA
- Kazaz, B., M. A. Perez, W. N. Donald, X. Fang, and J. N. Shaw. 2022. "Detection of Residual Flocculant Concentrations in Construction Stormwater Runoff." *Transportation Research Record: Journal of the Transportation Research Board*, 036119812210779. SAGE Publications. <https://doi.org/10.1177/03611981221077985>.
- Minnesota Pollution Control Agency (MPCA). (2020). "Minnesota Stormwater Manual."
- United States Department of Agriculture - Natural Resource Conservation. (1986). "Technical Release 55: Urban Hydrology for Small Watersheds." Washington, DC.
- Whitman, J. B., W. C. Zech, and W. N. Donald. (2019). "Full-Scale Performance Evaluations of Innovative and Manufactured Sediment Barrier Practices." *Transportation Research Record*, Vol. 2673 No. 8, 284–297.
- Whitman, J. B., W. C. Zech, W. N. Donald, and J. J. LaMondia. 2018. "Full-Scale Performance Evaluations of Various Wire-Backed Nonwoven Silt Fence Installation Configurations." *Transportation Research Record*, Vol. 2672 No. 39, 68–78.
- .

## **Appendix B: Sediment Barrier Testing Logs**



<b>Installation:</b>	I1-SF-STD
<b>Description:</b>	Silt Fence Standard
<b>Modification(s):</b>	N/A

<b>Impoundment Data</b>						
<b>Time</b>	<b>Test 1</b>		<b>Test 2</b>		<b>Test 3</b>	
<b>(min)</b>	<b>Depth (in)</b>	<b>Length (in)</b>	<b>Depth (in)</b>	<b>Length (in)</b>	<b>Depth (in)</b>	<b>Length (in)</b>
5				79	5	87
10	4.5	81	5.5	87	7.5	94
15	5.25	90	7	95	8.75	101
20	8.75	97	9	98	10	103
25	10	101	10.5	104	11.5	111
30	10.5	106	12	107	12.75	112
35	10	102	11.5	105	12.75	108
40	9.75	99	11.25	103	12.5	106
45	9.75	98	11	101	12.5	105
60	9.5	94	11	98	12	102
90	9.5	93	10	97	11.5	100
120	9	31	9.75	96	11.25	100

<b>Average Water Quality</b>								
<b>Time</b>	<b>Turbidity (NTU)</b>				<b>TSS (mg/L)</b>			
<b>(min)</b>	<b>Imp. Slope</b>	<b>U/S Top Water</b>	<b>U/S Bot. Water</b>	<b>Disc.</b>	<b>Imp. Slope</b>	<b>U/S Top Water</b>	<b>U/S Bot. Water</b>	<b>Disc.</b>
5	7,811	1,865	3,194		10,966	1,716	4,083	
10	10,011	1,892	3,040		17,077	1,940	3,319	
15	10,581	2,323	2,395		14,064	3,630	2,687	
20	11,084	1,701	2,067	2,097	14,397	1,384	2,278	1,310
25	4,456	1,763	2,178	1,941	6,331	2,604	1,560	1,293
30	14,188	1,273	2,275	1,972	16,372	1,118	1,753	1,387
35		1,395	1,354	1,411		2,593	926	922
40		1,393	1,202	1,247		1,913	796	800
45		1,094	914	1,165		2,343	696	729
60		1,061	980	990		1,576	624	589
90		939	837	935		4,000	467	558
120		1,009	753	835		3,627	453	490
<b>Average</b>	9,688	1,476	1,766	1,399	13,201	2,370	1,637	898

<b>Observations</b>
Sagging was apparent in installation. Fabric was tearing at zipties. Dewatered slowly. Water grab samples were unable to be taken early in most tests at the bottom of impoundment and discharge. Under excessive impoundment conditions (>20 in.) installation failed due to zipties tearing completely through fabric, led to immediate dewatering.

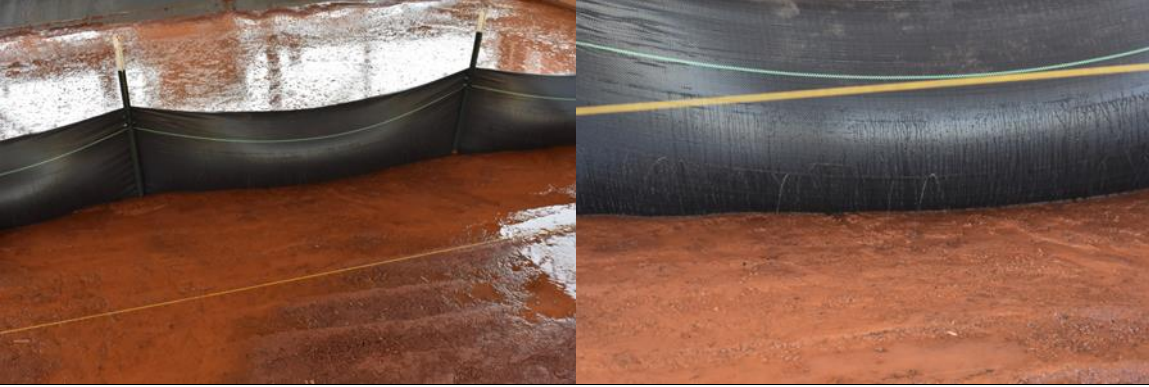
Water Quality: Test 1								
Time	Turbidity (NTU)				TSS (mg/L)			
(min)	Imp. Slope	U/S Top Water	U/S Bot. Water	Disc.	Imp. Slope	U/S Top Water	U/S Bot. Water	Disc.
5	2,628	1,892			13,007	1,343		
10	6,304	1,484	3,994		19,730	2,740	5,640	
15	8,224	1,566	2,094		11,033	2,823	4,157	
20	15,416	1,891	2,236	2,324	16,820	1,503	1,697	1,500
25	3,600	1,481	2,223	1,874	4,740	1,077	1,587	1,260
30	21,520	1,311	2,148	1,881	22,420	1,013	1,757	1,423
35		1,100	1,404	1,248		4,593	927	820
40		977	1,290	1,225		667	853	803
45		952	1,152	1,175		700	723	757
60		1,071	1,017	1,019		783	643	607
90		693		915		537		544
120		580				427		

Water Quality: Test 2								
Time	Turbidity (NTU)				TSS (mg/L)			
(min)	Imp. Slope	U/S Top	U/S Bot.	Disc.	Imp. Slope	U/S Top Water	U/S Bot. Water	Disc.
5	15,750	1,568			15,190	1,373		
10	17,772	1,804	2,442		21,637	1,383	2,140	
15	8,538	1,537	2,678		14,033	1,190	1,870	
20	6,864	1,462	1,451	2,364	12,273	1,077	1,347	1,310
25	4,536	1,384	2,022	2,272	6,660	1,220	1,343	1,477
30	4,076	1,183	2,106	2,201	6,790	790	1,497	1,430
35		1,274	1,418	1,376		907	963	810
40		1,472	1,248	1,341		1,720	837	827
45		1,270	1,122	1,211		1,667	740	740
60		1,243	1,060	1,094		2,293	647	633
90		1,161	917	1,038		2,100	480	643
120		1,093	827	935		2,130	490	513

Water Quality: Test 3								
Time	Turbidity (NTU)				TSS (mg/L)			
(min)	Imp. Slope	U/S Top Water	U/S Bot. Water	Disc.	Imp. Slope	U/S Top Water	U/S Bot. Water	Disc.
5	5,056	2,135	3,194		4,700	2,430	4,083	
10	5,956	2,388	2,684		9,863	1,697	2,177	
15	14,980	3,865	2,414		17,127	6,877	2,033	
20	10,972	1,751	2,514	1,602	14,097	1,573	3,790	1,120
25	5,232	2,424	2,288	1,677	7,593	5,517	1,750	1,143
30	16,968	1,325	2,572	1,835	19,907	1,550	2,007	1,307
35		1,811	1,241	1,610		2,280	887	1,137
40		1,730	1,068	1,176		3,353	697	770
45		1,059	467	1,109		4,663	623	690
60		868	862	856		1,650	583	527
90		964	757	852		9,363	453	487
120		1,355	678	735		8,323	417	467

<b><u>Pre-Test</u></b>	<b><u>During Test (Second)</u></b>	<b><u>Post-Test</u></b>
		
Location 1	Location 1	Location 1
		
Location 2	Location 2	Location 2
		
Location 3	Location 3	Location 3
		
Location 4	Location 4	Location 4
		
Location 5	Location 5	Location 5

Other Relevant Photos



Notes: Sagging and discharge through fabric

<b>Installation:</b>	I2-SM-STD
<b>Description:</b>	Slash Mulch Standard (3 by 6)
<b>Modification(s):</b>	N/A

<b>Impoundment Data</b>						
<b>Time</b>	<b>Test 1</b>		<b>Test 2</b>		<b>Test 3</b>	
<b>(min)</b>	<b>Depth (in)</b>	<b>Length (in)</b>	<b>Depth (in)</b>	<b>Length (in)</b>	<b>Depth (in)</b>	<b>Length (in)</b>
5	1.75	63	2.25	71	1.75	35
10	2	66	2.5	74	2	40
15	2.25	67	2.75	75	2.5	42
20	2.5	69	2.75	76	2.75	45
25	2.5	71	2.25	76	2.5	46
30	2.75	72	1.75	74	2.5	48
35	0.25	30	0.25	19	1	20
40	0.1	27	0	0	0.25	18
45	0	0			0.25	14
60					0	0
90						
120						

<b>Average Water Quality</b>								
<b>Time</b>	<b>Turbidity (NTU)</b>				<b>TSS (mg/L)</b>			
<b>(min)</b>	<b>Imp. Slope</b>	<b>U/S Top Water</b>	<b>U/S Bot. Water</b>	<b>Disc.</b>	<b>Imp. Slope</b>	<b>U/S Top Water</b>	<b>U/S Bot. Water</b>	<b>Disc.</b>
5	12,184	17,640		1,912	16,312	19,112		1,122
10	20,849	15,600		1,907	27,210	17,817		1,358
15	15,942	18,752		2,091	20,143	24,193		1,547
20	24,726	35,746		2,158	33,632	16,245		1,650
25	22,602	96,121		2,678	26,528	50,040		2,352
30	9,303	43,008		2,959	13,313	59,440		2,523
35				1,810				1,262
40				1,285				435
45								
60								
90								
120								
<b>Average</b>	17,601	37,811	-	2,100	22,856	31,141	-	1,531

<b>Observations</b>
High flow through rate. Low Impoundment facilitated. First discharge was at just over 3 minutes into test. due period for first test; time to first discharge decreased with each subsequent test. Due to low impoundment, grab samples were unable to be taken at the bottom of impoundment during testing. High upstream turbidity due to low

Water Quality: Test 1								
Time	Turbidity (NTU)				TSS (mg/L)			
(min)	Imp. Slope	U/S Top Water	U/S Bot. Water	Disc.	Imp. Slope	U/S Top Water	U/S Bot. Water	Disc.
5	14,647	36,314		1,455	14,875	37,820		720
10	26,460	9,440		1,445	35,430	9,845		860
15	33,715	5,163		1,355	38,685	4,875		595
20	22,722	5,872		1,375	30,925	7,060		665
25	31,487	63,549		1,685	36,765	77,965		770
30	7,101	174		1,765	10,495	28,625		960
35				1,375				565
40				1,285				435
45								
60								
90								
120								

Water Quality: Test 2								
Time	Turbidity (NTU)				TSS (mg/L)			
(min)	Imp. Slope	U/S Top	U/S Bot.	Disc.	Imp. Slope	U/S Top Water	U/S Bot. Water	Disc.
5	11,978	9,160		2,304	16,260	11,050		1,170
10	11,299	6,442		1,675	10,851	7,815		980
15	4,143	11,769		1,765	6,485	14,090		1,185
20	12,548	26,939		1,894	18,490	12,425		1,425
25	7,121	29,448		2,474	9,865	22,115		2,425
30	4,543	85,842		2,534	6,295	90,255		2,205
35				1,385				975
40								
45								
60								
90								
120								

Water Quality: Test 3								
Time	Turbidity (NTU)				TSS (mg/L)			
(min)	Imp. Slope	U/S Top Water	U/S Bot. Water	Disc.	Imp. Slope	U/S Top Water	U/S Bot. Water	Disc.
5	9,927	7,445		1,977	17,800	8,465		1,475
10	24,789	30,919		2,600	35,350	35,790		2,235
15	9,967	39,324		3,154	15,260	53,615		2,860
20	38,909	74,426		3,203	51,480	29,250		2,860
25	29,199	195,365		3,876	32,955			3,860
30	16,265			4,578	23,150			4,405
35				2,669				2,245
40								
45								
60								
90								
120								

<b>Pre-Test</b>	<b>During Test (Second)</b>	<b>Post-Test</b>
		
Location 1	Location 1	Location 1
		
Location 2	Location 2	Location 2
		
Location 3	Location 3	Location 3
		
Location 4	Location 4	Location 4
		
Location 5	Location 5	Location 5

Other Relevant Photos



Notes: Increased flow with each subsequent stormwater runoff event, flow coming through entire back edge



<b>Installation:</b>	I3-SF-STD-2
<b>Description:</b>	Silt Fence Std.
<b>Modification(s):</b>	N/A

<b>Impoundment Data</b>						
<b>Time</b>	<b>Test 1</b>		<b>Test 2</b>		<b>Test 3</b>	
<b>(min)</b>	<b>Depth (in)</b>	<b>Length (in)</b>	<b>Depth (in)</b>	<b>Length (in)</b>	<b>Depth (in)</b>	<b>Length (in)</b>
5						
10						
15						
20						
25						
30						
35						
40						
45						
60						
90						
120						

<b>Average Water Quality</b>								
<b>Time</b>	<b>Turbidity (NTU)</b>				<b>TSS (mg/L)</b>			
<b>(min)</b>	<b>Imp. Slope</b>	<b>U/S Top Water</b>	<b>U/S Bot. Water</b>	<b>Disc.</b>	<b>Imp. Slope</b>	<b>U/S Top Water</b>	<b>U/S Bot. Water</b>	<b>Disc.</b>
5								
10								
15								
20								
25								
30								
35								
40								
45								
60								
90								
120								
<b>Average</b>								

<b>Observations</b>
Installation failed due to undermining

Water Quality: Test 1								
Time	Turbidity (NTU)				TSS (mg/L)			
(min)	Imp. Slope	U/S Top Water	U/S Bot. Water	Disc.	Imp. Slope	U/S Top Water	U/S Bot. Water	Disc.
5								
10								
15								
20								
25								
30								
35								
40								
45								
60								
90								
120								

Water Quality: Test 2								
Time	Turbidity (NTU)				TSS (mg/L)			
(min)	Imp. Slope	U/S Top	U/S Bot.	Disc.	Imp. Slope	U/S Top Water	U/S Bot. Water	Disc.
5								
10								
15								
20								
25								
30								
35								
40								
45								
60								
90								
120								

Water Quality: Test 3								
Time	Turbidity (NTU)				TSS (mg/L)			
(min)	Imp. Slope	U/S Top Water	U/S Bot. Water	Disc.	Imp. Slope	U/S Top Water	U/S Bot. Water	Disc.
5								
10								
15								
20								
25								
30								
35								
40								
45								
60								
90								
120								

<b>Pre-Test</b>	<b>During Test (Second)</b>	<b>Post-Test</b>
		
Location 1	Location 1	Location 1
		
Location 2	Location 2	Location 2
		
Location 3	Location 3	Location 3
		
Location 4	Location 4	Location 4
		
Location 5	Location 5	Location 5

Other Relevant Photos



Notes: Undermining caused flow to dewater fully immediately, large hole created on both sides

<b>Installation:</b>	I4-SM-M1
<b>Description:</b>	1.5 ft by 3 ft Compacted in 3 lifts
<b>Modification(s):</b>	Reduced profile and compacted

<b>Impoundment Data</b>						
<b>Time</b>	<b>Test 1</b>		<b>Test 2</b>		<b>Test 3</b>	
<b>(min)</b>	<b>Depth (in)</b>	<b>Length (in)</b>	<b>Depth (in)</b>	<b>Length (in)</b>	<b>Depth (in)</b>	<b>Length (in)</b>
5	2	95	2	64	2	50
10	2.25	97	3.25	74	2.25	54
15	2.5	99	3.5	76	3	56
20	3	100	3.75	70	3.5	58
25	3.25	106	3.875	64	3.75	54
30	3.25	108	4	64	4	50
35	2.875	68	2.5	49	1.75	41
40	1	48	1	40	1	38
45	0.25	20	0.25	32	0.75	36
60	0	0	0.125	24	0.25	32
90			0	0	0	0
120						



<b>Average Water Quality</b>								
<b>Time</b>	<b>Turbidity (NTU)</b>				<b>TSS (mg/L)</b>			
<b>(min)</b>	<b>Imp. Slope</b>	<b>U/S Top Water</b>	<b>U/S Bot. Water</b>	<b>Disc.</b>	<b>Imp. Slope</b>	<b>U/S Top Water</b>	<b>U/S Bot. Water</b>	<b>Disc.</b>
5	9,339	6,463		483	14,906	9,853		897
10	21,410	5,850	3,016	574	36,384	13,551	2,236	479
15	16,530	3,456	4,103	497	14,357	11,132	5,596	256
20	17,859	1,869	7,010	526	27,897	5,305	8,142	252
25	8,309	3,786	2,984	540	14,194	11,881	2,646	509
30	16,429	3,855	2,879	556	21,312	6,067	943	201
35		2,721		528		2,200		200
40		3,044		388		3,564		169
45				323				171
60								
90				485				3,147
120								
<b>Average</b>	<b>14,979</b>	<b>3,880</b>	<b>3,998</b>	<b>490</b>	<b>21,508</b>	<b>7,944</b>	<b>3,913</b>	<b>628</b>

<b>Observations</b>
Facilitated more impoundment than standard berm. Visibly lower flow through rate than standard. First discharge at 3:13 in for first test, reduced time to discharge for each subsequent test.

Water Quality: Test 1								
Time	Turbidity (NTU)				TSS (mg/L)			
(min)	Imp. Slope	U/S Top Water	U/S Bot. Water	Disc.	Imp. Slope	U/S Top Water	U/S Bot. Water	Disc.
5	6,861	1,509		455	10,650	2,157		492
10	31,770	8,656		661	68,069	7,960		369
15	8,880			435	14,300	22,800		200
20	8,056	1,546		472	18,507	1,731		264
25	5,616		1,859	514	11,708	21,800	1,492	227
30	26,170	2,122	1,207	515	24,033	2,429	956	164
35		2,721		486		2,200		200
40		3,044		441		3,564		192
45				346				146
60								
90								
120								

Water Quality: Test 2								
Time	Turbidity (NTU)				TSS (mg/L)			
(min)	Imp. Slope	U/S Top	U/S Bot.	Disc.	Imp. Slope	U/S Top Water	U/S Bot. Water	Disc.
5	9,656	4,272		351	19,683	5,992		1,100
10	19,952	3,043	3,016	491	24,382	2,615	2,236	533
15	15,720	2,776	4,047	514	25,017	3,035	7,308	285
20	31,788	2,192	6,468	519	46,750	2,046	5,900	246
25	7,224	3,867		516	13,875	7,494		650
30	16,824	4,700		546	29,959	7,433		220
35								
40				395				158
45				280				184
60								
90				485				3,147
120								

Water Quality: Test 3								
Time	Turbidity (NTU)				TSS (mg/L)			
(min)	Imp. Slope	U/S Top Water	U/S Bot. Water	Disc.	Imp. Slope	U/S Top Water	U/S Bot. Water	Disc.
5	11,499	13,608		644	14,385	21,410		1,100
10	12,507			569	16,700	30,079		533
15	24,990	4,136	4,158	543	3,754	7,560	3,883	285
20	13,732		7,552	586	18,433	12,136	10,385	246
25	12,088	3,704	4,108	591	17,000	6,350	3,800	650
30	6,292	4,743	4,551	608	9,943	8,338	929	220
35				569				
40				328				158
45				342				184
60								
90								3,147
120								

Pre-Test	During Test (Second)	Post-Test
		
Location 1	Location 1	Location 1
		
Location 2	Location 2	Location 2
		
Location 3	Location 3	Location 3
		
Location 4	Location 4	Location 4
		
Location 5	Location 5	Location 5

Other Relevant Photos



Notes: Flow through berm, sediment deposition, and only bottom of berm having flow pass through



<b>Installation:</b>	I5-SF-STD
<b>Description:</b>	Silt Fence Std.
<b>Modification(s):</b>	N/A

<b>Impoundment Data</b>						
<b>Time</b>	<b>Test 1</b>		<b>Test 2</b>		<b>Test 3</b>	
<b>(min)</b>	<b>Depth (in)</b>	<b>Length (in)</b>	<b>Depth (in)</b>	<b>Length (in)</b>	<b>Depth (in)</b>	<b>Length (in)</b>
5	4.75	77	5	78	5.75	74
10	6.5	83	5.75	86	8.5	91
15	8	90	8.5	90	9.5	98
20	9.75	95	9.75	96	11	101
25	11.125	102	11.125	100	12.5	107
30	12.75	104	12	105	12.75	110
35	12.75	105	12	113	12.5	110
40	12.75	105	12	103	12.5	109
45	12.75	105	12	102	12.5	108
60	12.5	102	11.5	98	11.825	104
90	12	101			11.75	99
120	11.875	98	10.5	96	11	97








<b>Average Water Quality</b>								
<b>Time</b>	<b>Turbidity (NTU)</b>				<b>TSS (mg/L)</b>			
<b>(min)</b>	<b>Imp. Slope</b>	<b>U/S Top Water</b>	<b>U/S Bot. Water</b>	<b>Disc.</b>	<b>Imp. Slope</b>	<b>U/S Top Water</b>	<b>U/S Bot. Water</b>	<b>Disc.</b>
5	27,708	3,997	37,486		48,453	4,173	40,663	
10	39,632	1,467	4,887	3,232	60,627	1,540	5,343	3,060
15	26,961	1,008	3,274	1,910	45,605	1,097	3,080	2,240
20	21,909	1,223	3,463	1,564	42,004	1,453	3,253	1,325
25	13,079	1,228	2,645	1,630	30,115	1,080	2,363	1,527
30	54,747	1,111	2,642	1,637	70,820	1,273	2,120	1,927
35		1,260	905	936		1,227	770	690
40		1,768	896	609		1,007	680	640
45		1,045	702	749		930	523	690
60		1,044	583	620		1,260	1,147	527
90		1,102	497	697		1,450	980	547
120		647	444	474		523	337	313
<b>Average</b>	<b>30,673</b>	<b>1,408</b>	<b>4,869</b>	<b>1,278</b>	<b>49,604</b>	<b>1,418</b>	<b>5,105</b>	<b>1,226</b>

<b>Observations</b>
First two tests were similar to first silt fence installation. During test 3, some undermining became apparent. Zipties were tearing through fabric. Low post deflection.

Water Quality: Test 1								
Time	Turbidity (NTU)				TSS (mg/L)			
(min)	Imp. Slope	U/S Top Water	U/S Bot. Water	Disc.	Imp. Slope	U/S Top Water	U/S Bot. Water	Disc.
5	6,524	2,388	3,078		8,510	3,350	2,810	
10	18,136	1,373	2,131	3,232	27,560	1,900	1,940	3,060
15	8,344	974	2,394	1,910	13,625	1,040	2,300	2,240
20	15,408	1,109	2,454	1,652	28,992	1,470	2,530	1,690
25	8,496	793	2,075	1,730	14,206	570	2,060	1,760
30	30,990	1,051	1,877	1,586	89,780	790	1,490	1,550
35		767	897	1,107		1,090	980	930
40		613	897	731		670	640	640
45		640	631	891		570	570	650
60		1,527	578	455		2,220	570	400
90		1,333	478	568		2,530	420	550
120		475	438	433		370	130	300

Water Quality: Test 2								
Time	Turbidity (NTU)				TSS (mg/L)			
(min)	Imp. Slope	U/S Top	U/S Bot.	Disc.	Imp. Slope	U/S Top Water	U/S Bot. Water	Disc.
5	45,400	2,193	36,580		74,650	2,120	38,930	
10	63,080	1,411	4,150		103,190	960	5,890	
15	37,060	1,090	2,908		62,390	1,130	2,530	
20	31,220	1,407	3,916	1,476	61,360	1,850	4,010	960
25	11,880	1,180	2,890	1,563	21,440	1,100	2,670	1,240
30	40,360	935	2,860	1,556	72,250	950	2,460	1,480
35		1,177	958	736		920	760	520
40		860	1,008	-		550	860	470
45		829	695	675		870	500	1,020
60		927	541	596		970	840	420
90		695	474	572		620	330	470
120		949	417	451		840	200	390

Water Quality: Test 3								
Time	Turbidity (NTU)				TSS (mg/L)			
(min)	Imp. Slope	U/S Top Water	U/S Bot. Water	Disc.	Imp. Slope	U/S Top Water	U/S Bot. Water	Disc.
5	31,200	7,410	72,800		62,200	7,050	80,250	
10	37,680	1,618	8,380		51,130	1,760	8,200	
15	35,480	959	4,520		60,800	1,120	4,410	
20	19,100	1,152	4,020		35,660	1,040	3,220	
25	18,860	1,710	2,971	1,598	54,700	1,570	2,360	1,580
30	92,890	1,348	3,189	1,768	50,430	2,080	2,410	2,750
35		1,836	861	966		1,670	570	620
40		3,830	784	1,095		1,800	540	810
45		1,665	781	681		1,350	500	400
60		679	630	809		590	2,030	760
90		1,277	540	950		1,200	2,190	620
120		518	477	537		360	680	250

<b>Pre-Test</b>	<b>During Test (Second)</b>	<b>Post-Test</b>
		
Location 1	Location 1	Location 1
		
Location 2	Location 2	Location 2
		
Location 3	Location 3	Location 3
		
Location 4	Location 4	Location 4
		
Location 5	Location 5	Location 5

Other Relevant Photos



Notes: Flow under installation

<b>Installation:</b>	I6-SF-STD4
<b>Description:</b>	Silt Fence Standard
<b>Modification(s):</b>	N/A

<b>Impoundment Data</b>						
<b>Time</b>	<b>Test 1</b>		<b>Test 2</b>		<b>Test 3</b>	
<b>(min)</b>	<b>Depth (in)</b>	<b>Length (in)</b>	<b>Depth (in)</b>	<b>Length (in)</b>	<b>Depth (in)</b>	<b>Length (in)</b>
5	1.75	81	3.5	87	4.25	60
10	3.5	89	5.5	91	6.5	97
15	5	96	7.25	101	7.875	102
20	6	100	8.825	105	9	107
25	7.875	105	10	113	10.25	111
30	8.25	109	11.5	115	12	114
35	8.5	108	11.5	112	11.875	113.5
40	8.25	104	11.5	111	11.875	110
45	8	102	11.125	109	11.875	109
60	8	99	11	106	11.75	108
90	7.875	97	10.875	105	11.5	105
120	7.25	96	10.75	105	11.25	104

<b>Average Water Quality</b>								
<b>Time</b>	<b>Turbidity (NTU)</b>				<b>TSS (mg/L)</b>			
<b>(min)</b>	<b>Imp. Slope</b>	<b>U/S Top Water</b>	<b>U/S Bot. Water</b>	<b>Disc.</b>	<b>Imp. Slope</b>	<b>U/S Top Water</b>	<b>U/S Bot. Water</b>	<b>Disc.</b>
5	8,068	2,492			8,068	2,492		
10	13,719	1,862	3,039		13,719	1,862	3,039	
15	10,595	982	2,401	2,433	10,595	982	2,401	2,433
20	18,465	985	1,519	3,039	18,465	985	1,519	3,039
25	8,183	742	1,741	2,492	8,183	742	1,741	2,492
30	6,826	1,081	2,149	2,265	6,826	1,081	2,149	2,265
35		824	1,058	1,745		824	1,058	1,745
40		813	1,110	1,524		813	1,110	1,524
45		813	1,096	756		813	1,096	756
60		522	429	702		522	429	702
90		702	787	627		702	787	627
120		680	684	498		680	684	498
<b>Average</b>	<b>10,976</b>	<b>1,042</b>	<b>1,456</b>	<b>1,608</b>	<b>10,976</b>	<b>1,042</b>	<b>1,456</b>	<b>1,608</b>

<b>Observations</b>
Same as other Silt Fence Standard Installations. Slow Dewatering. Minimal Post Deflection. Equipment malfunction in Test 3 led to lack of bottom sampling. Not enough discharge through fabric during third test to sample. 76% sediment capture upstream.

Water Quality: Test 1								
Time	Turbidity (NTU)				TSS (mg/L)			
(min)	Imp. Slope	U/S Top Water	U/S Bot. Water	Disc.	Imp. Slope	U/S Top Water	U/S Bot. Water	Disc.
5	9,750	3,171			9,750	3,171		
10	26,890	2,499			26,890	2,499		
15	12,560	1,542	2,381	2,433	12,560	1,542	2,381	2,433
20	41,770	1,206	854	4,479	41,770	1,206	854	4,479
25	12,630	627	673	3,090	12,630	627	673	3,090
30	3,140	1,332	2,405	3,099	3,140	1,332	2,405	3,099
35		1,011	1,080	2,535		1,011	1,080	2,535
40		1,011	1,334	2,232		1,011	1,334	2,232
45		1,101	1,481			1,101	1,481	
60		239	158			239	158	
90		864	982			864	982	
120		774	855			774	855	

Water Quality: Test 2								
Time	Turbidity (NTU)				TSS (mg/L)			
(min)	Imp. Slope	U/S Top	U/S Bot.	Disc.	Imp. Slope	U/S Top Water	U/S Bot. Water	Disc.
5	1,365	1,755			1,365	1,755		
10	9,687	1,755	3,039		9,687	1,755	3,039	
15	10,995	424	2,421		10,995	424	2,421	
20	8,796	855	2,184	1,599	8,796	855	2,184	1,599
25	5,250	813	2,809	1,893	5,250	813	2,809	1,893
30	12,399	1,056	1,893	1,431	12,399	1,056	1,893	1,431
35		657	1,035	954		657	1,035	954
40		663	885	816		663	885	816
45		646	711	756		646	711	756
60		590	699	702		590	699	702
90		618	591	627		618	591	627
120		618	513	498		618	513	498

Water Quality: Test 3								
Time	Turbidity (NTU)				TSS (mg/L)			
(min)	Imp. Slope	U/S Top Water	U/S Bot. Water	Disc.	Imp. Slope	U/S Top Water	U/S Bot. Water	Disc.
5	13,090	2,550			13,090	2,550		
10	4,580	1,332			4,580	1,332		
15	8,230	981			8,230	981		
20	4,830	894			4,830	894		
25	6,670	786			6,670	786		
30	4,940	855			4,940	855		
35		804				804		
40		765				765		
45		693				693		
60		738				738		
90		624				624		
120		648				648		

Pre-Test	During Test (First)	Post-Test
		
Location 1	Location 1	Location 1
		
Location 2	Location 2	Location 2
		
Location 3	Location 3	Location 3
		
Location 4	Location 4	Location 4
		
Location 5	Location 5	Location 5

<b>Installation:</b>	I7-SF-M1
<b>Description:</b>	Offset trench, all else same as STD
<b>Modification(s):</b>	6" Offset Trench

<b>Impoundment Data</b>						
<b>Time</b>	<b>Test 1</b>		<b>Test 2</b>		<b>Test 3</b>	
<b>(min)</b>	<b>Depth (in)</b>	<b>Length (in)</b>	<b>Depth (in)</b>	<b>Length (in)</b>	<b>Depth (in)</b>	<b>Length (in)</b>
5	3.25	80	3.5	89	4	80
10	5	88	4.25	92	5.75	90
15	6.75	95	5.5	96	7	94
20	8.5	98	7.75	98	8.25	100
25	9.75	101	8.5	100	9.75	103
30	11	105	9.75	105	10.5	107
35	11	104	9.5	104	10.125	105
40	11	103	9.375	103	10	101
45	10.75	102	9.375	102	10	99
60	10.375	98	9	101	9.875	97
90	9.75	96	8.75	97	9.5	94
120	9.5	94	8	90	9	91

<b>Average Water Quality</b>								
<b>Time</b>	<b>Turbidity (NTU)</b>				<b>TSS (mg/L)</b>			
<b>(min)</b>	<b>Imp. Slope</b>	<b>U/S Top Water</b>	<b>U/S Bot. Water</b>	<b>Disc.</b>	<b>Imp. Slope</b>	<b>U/S Top Water</b>	<b>U/S Bot. Water</b>	<b>Disc.</b>
5	41,973	3,630			36,177	5,423	7,700	
10	24,727	4,327	5,115	3,460	40,530	6,427	5,275	3,520
15	11,977	4,301	4,323	3,400	13,780	5,017	7,187	2,870
20	23,843	3,331	4,569	2,985	43,410	4,387	4,790	2,225
25	17,970	3,268	4,413	2,922	27,943	3,557	4,327	2,990
30	19,450	4,269	2,955	2,825	29,570	6,007	2,660	2,280
35		1,406	2,168	1,808		783	1,475	1,305
40		1,300	1,754	1,789		473	1,103	1,090
45		1,334	1,496	1,662		850	840	1,740
60		1,135	1,404	2,399		740	767	2,020
90		954	1,301			1,373	760	
120		852	1,087			1,000	563	5,410
<b>Average</b>	23,323	2,509	2,780	2,583	31,902	3,003	3,121	2,545
















<b>Observations</b>
Less flow under fence was visible. Sagging and ziptie tearing through geotextile fabric still present. During extreme storm event testing, installation overtopped and did not otherwise fail.



Water Quality: Test 1								
Time	Turbidity (NTU)				TSS (mg/L)			
(min)	Imp. Slope	U/S Top Water	U/S Bot. Water	Disc.	Imp. Slope	U/S Top Water	U/S Bot. Water	Disc.
5	83,620	7,850			53,160	14,000		
10	36,100	9,850	3,669		70,640	17,610	3,690	
15	10,240	8,990	4,323		2,910	12,690	4,080	
20	45,960	6,000	5,256		88,720	10,970	4,670	
25	10,260	6,200	5,718		30,910	8,830	5,260	
30	8,780	9,230	2,715		24,610	16,090	2,430	
35		1,560	2,595	1,623		1,040	2,100	1,460
40		1,430	1,872			830	1,350	
45		1,490	1,434			1,310	1,080	
60		1,200	1,551			500	1,040	
90		1,010	1,275			870	850	
120		864	1,185			350	630	

Water Quality: Test 2								
Time	Turbidity (NTU)				TSS (mg/L)			
(min)	Imp. Slope	U/S Top	U/S Bot.	Disc.	Imp. Slope	U/S Top Water	U/S Bot. Water	Disc.
5	19,620	1,620			26,610	1,220	7,700	
10	11,600	1,420	6,560		21,700	790	6,860	
15	6,270	1,720		2,257	10,380	1,210	8,060	1,220
20	21,920	1,810	3,160	3,135	34,270	1,130	3,440	1,900
25	6,440	1,770	2,950		13,750	910	2,870	
30	23,210	1,780	2,800	3,184	25,510	1,090	2,770	2,110
35		1,370	1,740	1,992		790	850	1,150
40		1,230	1,530	1,789		200	720	1,090
45		1,360	1,400	1,763		770	520	2,330
60		1,060	1,260	2,399		1,250	700	2,020
90		916	1,070			2,860	550	
120		864	1,050			2,350	540	

Water Quality: Test 3								
Time	Turbidity (NTU)				TSS (mg/L)			
(min)	Imp. Slope	U/S Top Water	U/S Bot. Water	Disc.	Imp. Slope	U/S Top Water	U/S Bot. Water	Disc.
5	22,680	1,421			28,760	1,050		
10	26,480	1,710		3,460	29,250	880		3,520
15	19,420	2,193		4,542	28,050	1,150	9,420	4,520
20	3,650	2,182	5,290	2,835	7,240	1,060	6,260	2,550
25	37,210	1,835	4,570	2,922	39,170	930	4,850	2,990
30	26,360	1,797	3,350	2,466	38,590	840	2,780	2,450
35		1,289				520		
40		1,241	1,860			390	1,240	
45		1,153	1,655	1,560		470	920	1,150
60		1,146	1,400			470	560	
90		937	1,558			390	880	
120		829	1,027			300	520	5,410

<b><u>Pre-Test</u></b>	<b><u>During Test (Second)</u></b>	<b><u>Post-Test</u></b>
		
Location 1	Location 1	Location 1
		
Location 2	Location 2	Location 2
		
Location 3	Location 3	Location 3
		
Location 4	Location 4	Location 4
		
Location 5	Location 5	Location 5

Other Relevant Photos



Notes: No clear undermining, less tearing of zip ties through fabric, overtopping and post deflection under extreme-case simulated stormwater runoff event

<b>Installation:</b>	I8-SF-M2
<b>Description:</b>	Wooden Posts
<b>Modification(s):</b>	6" Offset Trench, Wooden Posts

<b>Impoundment Data</b>						
<b>Time</b>	<b>Test 1</b>		<b>Test 2</b>		<b>Test 3</b>	
<b>(min)</b>	<b>Depth (in)</b>	<b>Length (in)</b>	<b>Depth (in)</b>	<b>Length (in)</b>	<b>Depth (in)</b>	<b>Length (in)</b>
5	2.5	67	3.75	64	4.75	65
10	4.5	82	6	79	6.5	82
15	6	91	8.5	99	7.875	90
20	8.125	95	9.75	103	9	102
25	8.5	100	10.75	106	10.125	105
30	9	102	11.75	111	11	108
35	8.875	93	11.75	108	10.625	108
40	8.75	90	11.5	104	10.5	107
45	8.5	88	11.375	103	10.5	106
60	8	86	11	100	10.5	104
90	7	81	10.875	98	10	100
120	6.5	79	10	95	9.875	99












<b>Average Water Quality</b>								
<b>Time</b>	<b>Turbidity (NTU)</b>				<b>TSS (mg/L)</b>			
<b>(min)</b>	<b>Imp. Slope</b>	<b>U/S Top Water</b>	<b>U/S Bot. Water</b>	<b>Disc.</b>	<b>Imp. Slope</b>	<b>U/S Top Water</b>	<b>U/S Bot. Water</b>	<b>Disc.</b>
5	18,827	1,784	3,671		44,530	2,457	7,697	#DIV/0!
10	40,275	2,283	3,116	2,763	44,400	1,560	5,083	#DIV/0!
15	47,129	1,850	2,928	2,103	78,063	1,040	6,040	2,160
20	20,801	1,774	4,505	1,441	67,017	1,033	7,067	1,675
25	16,697	1,501	3,941	1,731	51,183	957	6,175	1,170
30	10,302	1,301	3,715	1,338	53,600	837	4,650	1,380
35		1,163	2,066	1,002		660	1,937	1,443
40		1,079	1,527	1,168		620	1,273	1,895
45		1,036	1,331	984		493	883	830
60		706	1,177	1,036		443	823	2,915
90		736	918	707		333	633	1,655
120		706	923			593	553	#DIV/0!
<b>Average</b>	25,672	1,326	2,485	1,427	56,466	919	3,568	#DIV/0!

<b>Observations</b>
Less sagging than I7 and other previous silt fence tests. Minimal post deflection. Extreme storm event test overtopped without failure.

Water Quality: Test 1								
Time	Turbidity (NTU)				TSS (mg/L)			
(min)	Imp. Slope	U/S Top Water	U/S Bot. Water	Disc.	Imp. Slope	U/S Top Water	U/S Bot. Water	Disc.
5	14,500	2,036	2,694		28,010	1,490	2,270	
10		2,785	2,519	2,763		1,680	1,680	
15	10,400	1,767	3,605	2,610	30,930	950	2,950	3,220
20	44,225	2,143	2,938	1,271	123,800	1,190	2,330	2,030
25	40,175	1,463	3,445	1,431	127,490	810	2,810	1,110
30	3,924	1,080	3,808	933	73,700	790	3,050	970
35		1,088	1,873			550	1,380	640
40		1,125	1,345			640	900	
45		1,072	1,290			410	730	
60		757	1,072			230	530	
90		638	927			210	440	
120		666	886			210	400	

Water Quality: Test 2								
Time	Turbidity (NTU)				TSS (mg/L)			
(min)	Imp. Slope	U/S Top	U/S Bot.	Disc.	Imp. Slope	U/S Top Water	U/S Bot. Water	Disc.
5	31,770	2,091	5,808		51,580	2,020	6,290	
10	68,820	1,491	4,023		27,460	1,220	4,110	
15	127,620		1,332	1,596	181,830		1,200	1,100
20	7,800	1,488		1,611	17,530	950	8,260	1,320
25	8,580	1,140		2,031	14,820	860	9,540	1,230
30	16,680	1,286	5,457	1,743	33,500	700	5,540	1,790
35		1,144	1,989	1,083		530	2,310	680
40		1,069	1,944	1,170		510	1,960	730
45		1,007	1,194	984		470	920	830
60		943	1,047	810		600	970	580
90		755	840	816		350	790	410
120		705	861			1,090	670	

Water Quality: Test 3								
Time	Turbidity (NTU)				TSS (mg/L)			
(min)	Imp. Slope	U/S Top Water	U/S Bot. Water	Disc.	Imp. Slope	U/S Top Water	U/S Bot. Water	Disc.
5	10,212	1,224	2,511		54,000	3,860	14,530	
10	11,730	2,573	2,805		61,340	1,780	9,460	
15	3,366	1,932	3,846		21,430	1,130	13,970	
20	10,377	1,691	6,072		59,720	960	10,610	
25	1,335	1,900	4,437		11,240	1,200		
30		1,536	1,881			1,020	5,360	
35		1,256	2,337	921		900	2,120	3,010
40		1,043	1,293	1,166		710	960	3,060
45		1,028	1,508			600	1,000	
60		418	1,413	1,261		500	970	5,250
90		816	988	597		440	670	2,900
120		748	1,022			480	590	

<b>Pre-Test (Second)</b>	<b>During Test (Second)</b>	<b>Post-Test</b>
		
Location 1	Location 1	Location 1
		
Location 2	Location 2	Location 2
		
Location 3	Location 3	Location 3
		
Location 4	Location 4	Location 4
		
Location 5	Location 5	Location 5

<b>Installation:</b>	I9-SF-M3
<b>Description:</b>	Backed Fabric
<b>Modification(s):</b>	Offset Trench, polypropylene backed fabric

<b>Impoundment Data</b>						
<b>Time</b>	<b>Test 1</b>		<b>Test 2</b>		<b>Test 3</b>	
<b>(min)</b>	<b>Depth (in)</b>	<b>Length (in)</b>	<b>Depth (in)</b>	<b>Length (in)</b>	<b>Depth (in)</b>	<b>Length (in)</b>
5	2.75	61	3.5	78	4.25	49
10	3	68	4.25	81	5.875	71
15	3.5	75	5	84	6	73
20	4	79	5.25	86	6.25	86
25	4.25	80	5.25	87	6.875	91
30	4.5	85	5.5	89	7.5	96
35	2.5	51	4.5	53	5.875	59
40	1.25	40	3.5	44	5	48
45	0	0	2.875	40	4	46
60			2.5	30	3.5	33
90			0	0	2.75	28
120					0	0

<b>Average Water Quality</b>								
<b>Time</b>	<b>Turbidity (NTU)</b>				<b>TSS (mg/L)</b>			
<b>(min)</b>	<b>Imp. Slope</b>	<b>U/S Top Water</b>	<b>U/S Bot. Water</b>	<b>Disc.</b>	<b>Imp. Slope</b>	<b>U/S Top Water</b>	<b>U/S Bot. Water</b>	<b>Disc.</b>
5	10,720	2,811	4,185	4,230	9,625	2,945	5,230	3,432
10	15,310	2,330	2,688	1,792	17,562	2,205	3,280	4,300
15	6,000	2,263	2,931	1,980	11,383	2,353	4,175	1,990
20	10,210	2,063	3,898	1,755	17,255	2,072	5,218	1,578
25	7,570	1,518	4,092	1,847	13,890	1,202	4,903	1,945
30	5,260	2,146	3,639	2,070	7,650	1,865	6,073	2,150
35		739	1,658	1,293		567	1,780	1,450
40		751	696			642	913	
45		783	586			662	560	
60		1,753	551			4,362	600	
90								
120								
<b>Average</b>	9,178	1,716	2,492	2,138	12,894	1,888	3,273	2,406

<b>Observations</b>
Fabric had less impoundment capabilities than installations previously tested with woven geotextile fabric. Unable to see if backing prevented sagging and provided structural support to installation. Notable increase increase in flow ratate when impoundment exceeded previous level. 67.8% sediment capture upstream.

Water Quality: Test 1								
Time	Turbidity (NTU)				TSS (mg/L)			
(min)	Imp. Slope	U/S Top Water	U/S Bot. Water	Disc.	Imp. Slope	U/S Top Water	U/S Bot. Water	Disc.
5	26,030	1,614		6,258	17,890	1,410		2,090
10	20,560	3,996		1,353	18,970	3,770		8,710
15	2,070	3,912		1,020	3,680	4,010		850
20	11,810	3,603	2,751	1,251	18,320	3,520	2,890	1,140
25	5,060	2,574	3,933	1,260	9,440	700	4,150	830
30	2,120	3,636		1,452	2,720	3,130		1,140
35								
40								
45								
60								
90								
120								

Water Quality: Test 2								
Time	Turbidity (NTU)				TSS (mg/L)			
(min)	Imp. Slope	U/S Top	U/S Bot.	Disc.	Imp. Slope	U/S Top Water	U/S Bot. Water	Disc.
5	4,180	3,210	5,292	3,180	7,280	3,400	6,090	5,560
10	8,720	1,521	1,899	1,380	7,590	1,590	2,290	1,830
15	7,350	1,419	2,673	2,985	11,510	1,790	3,340	3,350
20	6,860	1,350	1,755	1,932	12,770	1,670	2,570	1,690
25	7,200	1,146	1,980	2,634	10,970	1,020	2,280	3,600
30	8,400	1,404	2,169	3,753	12,580	1,210	2,790	4,440
35		849	1,101	1,293		620	1,200	1,450
40		1,020	711			710	580	
45		864	498			780	400	
60			642			6,970	740	
90								
120								

Water Quality: Test 3								
Time	Turbidity (NTU)				TSS (mg/L)			
(min)	Imp. Slope	U/S Top Water	U/S Bot. Water	Disc.	Imp. Slope	U/S Top Water	U/S Bot. Water	Disc.
5	1,949	3,609	3,078	3,253	3,705	4,025	4,370	2,645
10	16,650	1,473	3,477	2,642	26,125	1,255	4,270	2,360
15	8,580	1,457	3,189	1,935	18,960	1,260	5,010	1,770
20	11,960	1,237	7,188	2,081	20,675	1,025	10,195	1,905
25	10,450	833	6,363	1,646	21,260	1,885	8,280	1,405
30		1,398	5,109	1,005		1,255	9,355	870
35		628	2,215			515	2,360	
40		482	680			575	1,245	
45		701	674			545	720	
60		1,753	460			1,755	460	
90								
120								



Other Relevant Photos



Notes: Visibly higher flow through fabric than other woven fabric tested

<b>Installation:</b>	I10-SF-HP
<b>Description:</b>	High Porosity
<b>Modification(s):</b>	High Flow Fabric

<b>Impoundment Data</b>						
<b>Time</b>	<b>Test 1</b>		<b>Test 2</b>		<b>Test 3</b>	
<b>(min)</b>	<b>Depth (in)</b>	<b>Length (in)</b>	<b>Depth (in)</b>	<b>Length (in)</b>	<b>Depth (in)</b>	<b>Length (in)</b>
5	0	0	0.5	18	1	44
10	2	18	0.75	26	2	38
15	2.25	19	1	28	2.5	38
20	2.5	22	1.25	31	3.5	37
25	2.5	24	1.25	32	4	36
30	2.75	26	1.375	32	4.25	34
35	2	18	0.75	14	3	30
40	1.75	14	0	0	2.5	29
45	1.75	8			2.5	28
60	0	0			2.25	28
90					0	0
120						

<b>Average Water Quality</b>								
<b>Time</b>	<b>Turbidity (NTU)</b>				<b>TSS (mg/L)</b>			
	<b>Imp. Slope</b>	<b>U/S Top Water</b>	<b>U/S Bot. Water</b>	<b>Disc.</b>	<b>Imp. Slope</b>	<b>U/S Top Water</b>	<b>U/S Bot. Water</b>	<b>Disc.</b>
5	14,805	6,042		4,197	27,820	15,062		6,697
10	15,111	4,736		4,498	32,090	10,410		6,523
15	7,787	7,337		2,870	18,443	18,513		4,435
20	15,449	4,800		3,014	26,953	14,808		4,843
25	31,363	4,901		2,789	56,850	27,582		4,072
30	15,540	3,205		4,778	28,798	12,247		8,415
35		4,115				4,400		
40		5,204				4,290		
45		2,563				2,080		
60		1,686				2,170		
90								
120								
<b>Average</b>	16,676	4,459	-	3,691	31,826	11,156	-	5,831

<b>Observations</b>
Very little impoundment facilitated and flow was able to pass through installation easily. Samples at bottom of impoundment were unable to be taken due to low impoundment depths. 71% sediment capture.

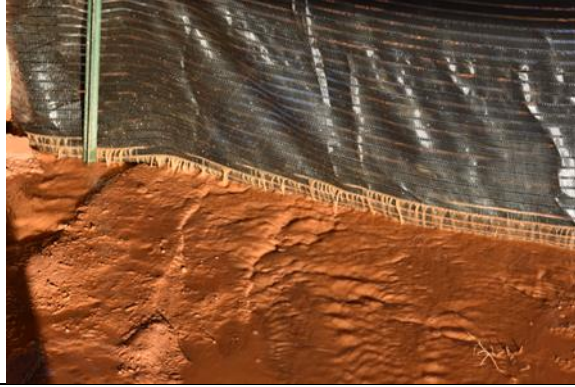
Water Quality: Test 1								
Time	Turbidity (NTU)				TSS (mg/L)			
(min)	Imp. Slope	U/S Top Water	U/S Bot. Water	Disc.	Imp. Slope	U/S Top Water	U/S Bot. Water	Disc.
5	25790	4050		7216	52290	9410		13140
10	14090	4318		7888	39140	9240		11850
15	8500	3136		3515	31650	6270		4990
20	26060	4192		3725	54810	12170		5390
25	51675	3872		3284	89290	6480		6220
30	9850	4362		7160	39700	8110		13890
35								
40								
45								
60								
90								
120								

Water Quality: Test 2								
Time	Turbidity (NTU)				TSS (mg/L)			
(min)	Imp. Slope	U/S Top	U/S Bot.	Disc.	Imp. Slope	U/S Top Water	U/S Bot. Water	Disc.
5	14460	11140		2688	22540	32370		4600
10	26290	7280		3127	44170	19820		5630
15	11460	16260		2670	14300	47000		6220
20	9880	8110		2889	8330	30740		5390
25	11050	7780		1939	24410	73920		3720
30	9200			3309	12850	27110		8400
35								
40								
45								
60								
90								
120								

Water Quality: Test 3								
Time	Turbidity (NTU)				TSS (mg/L)			
(min)	Imp. Slope	U/S Top Water	U/S Bot. Water	Disc.	Imp. Slope	U/S Top Water	U/S Bot. Water	Disc.
5	4166	2937		2688	8630	3405		2350
10	4954	2611		2479	12960	2170		2090
15	3400	2614		2425	9380	2270		2095
20	10407	2099		2427	17720	1515		3750
25		3050		3145		2345		2275
30	27570	2047		3865	33845	1520		2955
35		4115				4400		
40		5204				4290		
45		2563				2080		
60		1686				2170		
90								
120								

<b>Pre-Test (Second)</b>	<b>During Test (Second)</b>	<b>Post-Test</b>
		
Location 1	Location 1	Location 1
		
Location 2	Location 2	Location 2
		
Location 3	Location 3	Location 3
		
Location 4	Location 4	Location 4
		
Location 5	Location 5	Location 5

Other Relevant Photos



Notes: High flow through rate

<b>Installation:</b>	I11-SF-M4
<b>Description:</b>	Dewatering Board
<b>Modification(s):</b>	Offset trench, dewatering board w/ overflow weir

<b>Impoundment Data</b>						
<b>Time</b>	<b>Test 1</b>		<b>Test 2</b>		<b>Test 3</b>	
<b>(min)</b>	<b>Depth (in)</b>	<b>Length (in)</b>	<b>Depth (in)</b>	<b>Length (in)</b>	<b>Depth (in)</b>	<b>Length (in)</b>
5	3	85	4	83	4.25	66
10	5	88	6.5	95	5.75	93
15	6.5	91	8	100	7	98
20	8	98	9	106	8.25	103
25	9.5	101	10	108	9.5	108
30	10.5	107	10.75	111	10.5	110
35	10	98	10.75	98	10.25	107
40	9.75	97	10.625	96	10	99
45	9.75	94	10.5	94	9.825	97
60	9	93	5	92	9.75	96
90	8.25	91	9.5	91	9.125	91
120	7.25	88	8.75	89	8.375	89

<b>Average Water Quality</b>								
<b>Time</b>	<b>Turbidity (NTU)</b>				<b>TSS (mg/L)</b>			
<b>(min)</b>	<b>Imp. Slope</b>	<b>U/S Top Water</b>	<b>U/S Bot. Water</b>	<b>Disc.</b>	<b>Imp. Slope</b>	<b>U/S Top Water</b>	<b>U/S Bot. Water</b>	<b>Disc.</b>
5	16,877	3,151	5,171		19,313	2,577	8,375	
10	38,470	1,740	3,238	1,455	33,670	1,257	6,612	1,220
15	26,715	1,494	3,359	1,610	26,405	3,502	5,118	1,295
20	22,101	1,326	5,144	2,155	30,683	860	3,513	1,580
25	118,777	1,013	3,083	1,700	27,020	600	5,833	1,073
30	28,417	961	4,930	1,573	26,673	635	4,538	1,220
35		591	2,383	865		348	5,788	895
40		608	1,367	769		313	1,135	618
45		513	1,081	517		478	1,012	447
60		442	768	894		275	690	1,035
90		1,042	497	350		665	507	325
120		249	448	278		330	373	1,093
<b>Average</b>	<b>41,893</b>	<b>1,094</b>	<b>2,622</b>	<b>1,106</b>	<b>27,294</b>	<b>987</b>	<b>3,625</b>	<b>982</b>

<b>Observations</b>
Impoundment never reached height of overflow weir. Dewatered faster than previous installations without dewatering board. Under excessive impoundment conditions, impoundment overtopped at fabric and not weir due to sagging.

Water Quality: Test 1								
Time	Turbidity (NTU)				TSS (mg/L)			
(min)	Imp. Slope	U/S Top Water	U/S Bot. Water	Disc.	Imp. Slope	U/S Top Water	U/S Bot. Water	Disc.
5	9453	2241	4227		13990	2370	3990	
10	14050	1326	2799	1513	14140	970	1880	1480
15	8976	1333	2353	1913	9610	870	1720	1710
20	8862	1163	2442	3393	18500	890	1830	2390
25	9870	915	2157	1994	12690	190	1730	1480
30	5466	1057	2280	1748	7310	700	1710	1390
35		645	2228	1103		300	11350	660
40		500	1164	650		210	1080	470
45		554	856	540		490	790	460
60		753	733	583		370	690	640
90		1449	453	329		840	390	170
120		292	417	295		180	310	260

Water Quality: Test 2								
Time	Turbidity (NTU)				TSS (mg/L)			
(min)	Imp. Slope	U/S Top	U/S Bot.	Disc.	Imp. Slope	U/S Top Water	U/S Bot. Water	Disc.
5	12369	2373	6115		12780	2030	8340	
10	40660	1438	3677	1397	53200	1150	15550	960
15	40430	1861	4365	1306	42590	8580	4110	880
20	27920	1067	4295	1793	18240	640	1710	1310
25	24380	963		1672	24570	700	12720	760
30	41895	766	6895	1470	46810	500	7050	1280
35		729	1681	749		510	1280	1300
40		659	1900	863		430	1280	750
45		533	1456	499		350	1250	440
60		333	871	392		180	610	280
90			656	362			790	330
120		215	417	237		430	300	190

Water Quality: Test 3								
Time	Turbidity (NTU)				TSS (mg/L)			
(min)	Imp. Slope	U/S Top Water	U/S Bot. Water	Disc.	Imp. Slope	U/S Top Water	U/S Bot. Water	Disc.
5	28810	4840			31170	3330	12795	
10	60700	2456				1650	2405	
15	30740	1289			27015	1055	9525	
20	29520	1748	8695	1279	55310	1050	7000	1040
25	322080	1161	4008	1435	43800	910	3050	980
30	37890	1061	5616	1502	25900	705	4855	990
35		398	3241	743		235	4735	725
40		666	1037	795		300	1045	635
45		452	931	512		595	995	440
60		241	701	1708			770	2185
90		634	382	359		490	340	475
120		239	509	301		380	510	2830

<b>Pre-Test</b>	<b>During Test (Second)</b>	<b>Post-Test</b>
		
Location 1	Location 1	Location 1
		
Location 2	Location 2	Location 2
		
Location 3	Location 3	Location 3
		
Location 4	Location 4	Location 4
		
Location 5	Location 5	Location 5



Other Relevant Photos



Notes: Overtopping at fabric under excessive impoundment conditions due to sagging

<b>Installation:</b>	I12-SW-STD
<b>Description:</b>	Straw Wattle Standard
<b>Modification(s):</b>	N/A

<b>Impoundment Data</b>						
<b>Time</b>	<b>Test 1</b>		<b>Test 2</b>		<b>Test 3</b>	
<b>(min)</b>	<b>Depth (in)</b>	<b>Length (in)</b>	<b>Depth (in)</b>	<b>Length (in)</b>	<b>Depth (in)</b>	<b>Length (in)</b>
5	0.25	30				
10	0.25	36				
15	1	38				
20	1.25	39				
25	1.25	43				
30	1.5	46				
35	0	0				
40						
45						
60						
90						
120						














<b>Average Water Quality</b>								
<b>Time</b>	<b>Turbidity (NTU)</b>				<b>TSS (mg/L)</b>			
<b>(min)</b>	<b>Imp. Slope</b>	<b>U/S Top Water</b>	<b>U/S Bot. Water</b>	<b>Disc.</b>	<b>Imp. Slope</b>	<b>U/S Top Water</b>	<b>U/S Bot. Water</b>	<b>Disc.</b>
5				20,358	50,515			11,170
10		13,220		8,110	77,240	15,480		7,460
15		13,250		6,600	50,740	16,710		7,830
20				5,990	63,080			5,890
25				8,670	66,820			7,480
30				8,308	49,330			6,760
35								
40								
45								
60								
90								
120								
<b>Average</b>	-	13,235	-	9,673	59,621	16,095	-	7,765

<b>Observations</b>
Clear undermining occurred due to lack of contact between wattles and ground. Very little impoundment facilitated. Only ran one test on installation due to clear failure. 59.3% of introduced sediment captured upstream

Water Quality: Test 1								
Time	Turbidity (NTU)				TSS (mg/L)			
(min)	Imp. Slope	U/S Top Water	U/S Bot. Water	Disc.	Imp. Slope	U/S Top Water	U/S Bot. Water	Disc.
5				20358	50515			11170
10		13220		8110	77240	15480		7460
15		13250		6600	50740	16710		7830
20				5990	63080			5890
25				8670	66820			7480
30				8308	49330			6760
35								
40								
45								
60								
90								
120								

Water Quality: Test 2								
Time	Turbidity (NTU)				TSS (mg/L)			
(min)	Imp. Slope	U/S Top	U/S Bot.	Disc.	Imp. Slope	U/S Top Water	U/S Bot. Water	Disc.
5								
10								
15								
20								
25								
30								
35								
40								
45								
60								
90								
120								

Water Quality: Test 3								
Time	Turbidity (NTU)				TSS (mg/L)			
(min)	Imp. Slope	U/S Top Water	U/S Bot. Water	Disc.	Imp. Slope	U/S Top Water	U/S Bot. Water	Disc.
5								
10								
15								
20								
25								
30								
35								
40								
45								
60								
90								
120								

Pre-Test	During Test (Second)	Post-Test
		
Location 1	Location 1	Location 1
		
Location 2	Location 2	Location 2
		
Location 3	Location 3	Location 3
		
Location 4	Location 4	Location 4
		
Location 5	Location 5	Location 5

Other Relevant Photos



Notes: Trench during installation, flow under during testing, lack of impoundment formed by extreme case

<b>Installation:</b>	I13-SM-M2
<b>Description:</b>	1' by 6' Slash Mulch Berm
<b>Modification(s):</b>	Reduced height and increased width

<b>Impoundment Data</b>						
<b>Time</b>	<b>Test 1</b>		<b>Test 2</b>		<b>Test 3</b>	
<b>(min)</b>	<b>Depth (in)</b>	<b>Length (in)</b>	<b>Depth (in)</b>	<b>Length (in)</b>	<b>Depth (in)</b>	<b>Length (in)</b>
5	2.5	68	3.25	58	2.5	58
10	3.75	77	4.25	64	3	65
15	4	78	4.75	62	3.5	66
20	4.5	82	4.75	58	3.75	68
25	4.75	87	5	54	4	72
30	5	87	5	52	4.125	66
35	3	60	2.5	50	2.25	58
40	2	58	2	48	1.5	48
45	1	52	1	45	1	44
60	0.25	38	0.5	36	0.5	34
90	0	0	0	0	0	0
120						

<b>Average Water Quality</b>								
<b>Time</b>	<b>Turbidity (NTU)</b>				<b>TSS (mg/L)</b>			
<b>(min)</b>	<b>Imp. Slope</b>	<b>U/S Top Water</b>	<b>U/S Bot. Water</b>	<b>Disc.</b>	<b>Imp. Slope</b>	<b>U/S Top Water</b>	<b>U/S Bot. Water</b>	<b>Disc.</b>
5	4,635	3,909	5,262	2,728	12,230	3,655	6,855	1,730
10	36,083	3,532	7,861	1,529	36,100	3,125	9,745	778
15	8,751	2,749	6,228	1,484	18,000	2,593	9,535	912
20	14,065	2,924	4,817	2,072	38,933	2,487	5,218	1,447
25	20,003	3,204	7,286	1,760	31,223	3,030	14,288	1,248
30	29,761	3,837	12,830	2,310	81,193	4,002	6,690	1,853
35		6,291	5,051	1,358		17,223	5,790	938
40		11,628	17,145	682		11,630	31,010	642
45		5,532		506		4,412		257
60								
90								
120								
<b>Average</b>	<b>18,883</b>	<b>4,845</b>	<b>8,310</b>	<b>1,603</b>	<b>36,280</b>	<b>5,795</b>	<b>11,141</b>	<b>1,090</b>

<b>Observations</b>
Similar impoundment and flow rate from Slash Mulch Modification 1. First discharge 4 minutes into test, earlier under each subsequent test. Under extreme conditions, installation did not overtop.

Water Quality: Test 1								
Time	Turbidity (NTU)				TSS (mg/L)			
(min)	Imp. Slope	U/S Top Water	U/S Bot. Water	Disc.	Imp. Slope	U/S Top Water	U/S Bot. Water	Disc.
5	4,860	2,604		3,602	8,280	3,200	4,240	2,530
10	33,990	3,756	3,270	1,491	48,570	3,705	2,630	580
15	13,806	2,562	2,406	1,147	20,110	2,510	6,840	780
20	23,210	3,294	6,120	986	55,680	3,720	6,970	700
25	15,978	3,240	4,656	993	25,640	3,655	20,450	725
30	18,762	4,098	17,610	903	25,280	3,880	6,055	530
35		2,094	4,278	701		2,510	5,250	485
40		4,662	1,920	606		5,630		465
45		5,532		564		4,412		295
60								
90								
120								

Water Quality: Test 2								
Time	Turbidity (NTU)				TSS (mg/L)			
(min)	Imp. Slope	U/S Top	U/S Bot.	Disc.	Imp. Slope	U/S Top Water	U/S Bot. Water	Disc.
5	2,874	7,236	7,866	3,101	13,430	6,020	13,120	1,610
10	70,340	4,086	12,444	1,401	49,970	4,440	18,560	700
15	8,538	4,050	13,536	1,671	25,280	4,140	18,400	980
20	6,294	3,702		1,544	32,230	3,160		930
25	28,860	3,984		1,660	31,300	3,880		1,070
30		5,718		2,481	79,170	6,620		1,570
35				1,219		37,990		720
40				861				500
45				448				220
60								
90								
120								

Water Quality: Test 3								
Time	Turbidity (NTU)				TSS (mg/L)			
(min)	Imp. Slope	U/S Top Water	U/S Bot. Water	Disc.	Imp. Slope	U/S Top Water	U/S Bot. Water	Disc.
5	6,170	1,888	2,658	1,480	14,980	1,745	3,205	1,050
10	3,920	2,755	7,869	1,696	9,760	1,230	8,045	1,055
15	3,910	1,635	2,742	1,633	8,610	1,130	3,365	975
20	12,690	1,775	3,513	3,686	28,890	580	3,465	2,710
25	15,170	2,389	9,915	2,626	36,730	1,555	8,125	1,950
30	40,760	1,695	8,049	3,546	139,130	1,505	7,325	3,460
35		10,488	5,823	2,155		11,170	6,330	1,610
40		18,594	32,370	578		17,630	31,010	960
45								
60								
90								
120								

Pre-Test	During Test (Second)	Post-Test
Location 1	Location 1	Location 1
Location 2	Location 2	Location 2
Location 3	Location 3	Location 3
Location 4	Location 4	Location 4
Location 5	Location 5	Location 5



Other Relevant Photos



Notes: Impoundment formed during extreme-case runoff event, did not overtop

<b>Installation:</b>	I14-SM-M1-2
<b>Description:</b>	1.5' by 3' Slash Mulch Berm
<b>Modification(s):</b>	Reduced profile, compacted, MFE-I

<b>Impoundment Data</b>						
<b>Time</b>	<b>Test 1</b>		<b>Test 2</b>		<b>Test 3</b>	
<b>(min)</b>	<b>Depth (in)</b>	<b>Length (in)</b>	<b>Depth (in)</b>	<b>Length (in)</b>	<b>Depth (in)</b>	<b>Length (in)</b>
5	2.5	68	2.75	64	3.75	62
10	3.5	90	3.75	68	4	58
15	4	98	4	66	4.25	52
20	4.25	93	4.25	58	4.5	48
25	4.25	93	4.375	58	4.75	46
30	4.375	88	4.5	57	4.875	46
35	2.875	64	2.75	52	2.75	40
40	1.5	60	1.5	40	1.75	38
45	1	58	1.25	36	1	32
60	0.5	50	0	0	0	0
90	0	0				
120						

<b>Average Water Quality</b>								
<b>Time</b>	<b>Turbidity (NTU)</b>				<b>TSS (mg/L)</b>			
<b>(min)</b>	<b>Imp. Slope</b>	<b>U/S Top Water</b>	<b>U/S Bot. Water</b>	<b>Disc.</b>	<b>Imp. Slope</b>	<b>U/S Top Water</b>	<b>U/S Bot. Water</b>	<b>Disc.</b>
5	20,348	5,083	10,193	3,186	17,040	3,867	7,897	2,097
10	12,835	4,665	6,088	2,953	6,934	3,750	4,910	1,687
15	21,202	3,687	3,826	2,132	14,620	2,803	3,300	1,207
20	21,995	6,155	6,388	1,688	18,187	6,540	4,933	1,030
25	26,503	7,393	6,801	2,043	23,393	6,337	6,187	1,143
30	12,675	8,402	11,008	1,889	10,610	6,300	9,163	977
35		27,400	28,918	1,376		24,150	15,335	837
40				847		127,150		397
45								
60								
90								
120								
<b>Average</b>	19,260	8,969	10,460	2,014	15,131	22,612	7,389	1,172

<b>Observations</b>
Same as first installation of M1

Water Quality: Test 1								
Time	Turbidity (NTU)				TSS (mg/L)			
(min)	Imp. Slope	U/S Top Water	U/S Bot. Water	Disc.	Imp. Slope	U/S Top Water	U/S Bot. Water	Disc.
5	24,380	2,965	4,923	3,216	29,100	2,330	4,320	2,390
10	9,130	5,481	3,894	3,162	7,550	4,240	3,330	1,430
15	41,360	3,660	2,712	2,080	26,000	3,110	2,530	760
20	30,830	9,720	5,010	1,308	25,080	11,560	3,950	530
25	24,820	6,840	5,700	1,618	19,350	6,230	6,550	630
30	8,020	8,991	9,459	1,734	7,060	8,130	8,760	770
35		17,190		1,192		15,790		530
40				851				370
45								
60								
90								
120								

Water Quality: Test 2								
Time	Turbidity (NTU)				TSS (mg/L)			
(min)	Imp. Slope	U/S Top	U/S Bot.	Disc.	Imp. Slope	U/S Top Water	U/S Bot. Water	Disc.
5	5,185	9,410	6,786	3,375	6,460	7,200	4,660	2,110
10	12,035	4,865	2,679	2,955	1,011	4,020	1,770	2,130
15	11,735	4,230	3,156	1,989	11,450	3,050	2,280	1,490
20	7,725	3,015	8,190	1,674	10,300	3,790	5,310	1,180
25	37,130	8,805	7,572	1,554	30,080	7,330	5,250	870
30	8,125	4,725	20,215	1,431	10,580	3,950	14,910	990
35		5,670	53,180	1,113		5,310	26,340	670
40				672		127,150		440
45								
60								
90								
120								

Water Quality: Test 3								
Time	Turbidity (NTU)				TSS (mg/L)			
(min)	Imp. Slope	U/S Top Water	U/S Bot. Water	Disc.	Imp. Slope	U/S Top Water	U/S Bot. Water	Disc.
5	31,480	2,875	18,870	2,967	15,560	2,070	14,710	1,790
10	17,340	3,650	11,690	2,742	12,240	2,990	9,630	1,500
15	10,510	3,170	5,610	2,328	6,410	2,250	5,090	1,370
20	27,430	5,730	5,965	2,082	19,180	4,270	5,540	1,380
25	17,560	6,534	7,130	2,958	20,750	5,450	6,760	1,930
30	21,880	11,490	3,350	2,502	14,190	6,820	3,820	1,170
35		59,340	4,655	1,824		51,350	4,330	1,310
40				1,017				380
45								
60								
90								
120								

Pre-Test	During Test (Second)	Post-Test
		
Location 1	Location 1	Location 1
		
Location 2	Location 2	Location 2
		
Location 3	Location 3	Location 3
		
Location 4	Location 4	Location 4
		
Location 5	Location 5	Location 5

<b>Installation:</b>	I15-SM-M1-3
<b>Description:</b>	1.5' by 3' Slash Mulch Berm
<b>Modification(s):</b>	Reduced profile, compacted, MFE-I

<b>Impoundment Data</b>						
<b>Time</b>	<b>Test 1</b>		<b>Test 2</b>		<b>Test 3</b>	
<b>(min)</b>	<b>Depth (in)</b>	<b>Length (in)</b>	<b>Depth (in)</b>	<b>Length (in)</b>	<b>Depth (in)</b>	<b>Length (in)</b>
5	1.75	80	2.5	66	3.5	42
10	2.5	92	3.5	72	3.75	48
15	3	75	3.625	64	3.825	44
20	3.25	72	3.75	58	4	42
25	3.75	68	3.875	52	4.125	40
30	4	66	4	50	4.125	40
35	2	60	2.5	44	2.825	36
40	1.5	56	1.75	38	2	34
45	0.75	50	1	36	1.75	30
60	0	0	0.25	32	0.75	28
90			0	0	0	0
120						















<b>Average Water Quality</b>								
<b>Time</b>	<b>Turbidity (NTU)</b>				<b>TSS (mg/L)</b>			
<b>(min)</b>	<b>Imp. Slope</b>	<b>U/S Top Water</b>	<b>U/S Bot. Water</b>	<b>Disc.</b>	<b>Imp. Slope</b>	<b>U/S Top Water</b>	<b>U/S Bot. Water</b>	<b>Disc.</b>
5	12,810	7,135	18,815	4,046	17,553	7,377	17,840	1,753
10	11,540	2,496	5,030	1,570	18,290	2,577	4,810	827
15	13,220	2,452	4,279	1,128	22,703	2,460	3,970	627
20	36,523	4,390	2,683	1,590	56,753	3,673	2,413	833
25	22,140	3,519	9,602	1,491	39,670	3,517	7,600	760
30	24,930	6,947	21,984	1,573	30,543	4,867	16,473	1,013
35		65,429	5,124	923		53,780	35,395	480
40		250,080	112,560	732		103,140	73,970	333
45		4,121		636		71,950		365
60								
90								
120								
<b>Average</b>	20,194	38,508	22,510	1,521	30,919	28,149	20,309	777

<b>Observations</b>
Same as previous M1 tests. 73.5% capture upstream.

Water Quality: Test 1								
Time	Turbidity (NTU)				TSS (mg/L)			
(min)	Imp. Slope	U/S Top Water	U/S Bot. Water	Disc.	Imp. Slope	U/S Top Water	U/S Bot. Water	Disc.
5	5,250	12,060	34,160	2,608	9,540	11,510	29,140	1,560
10	7,950	2,832	9,610	1,499	12,860	2,600	9,590	810
15	14,550	3,610	4,470	1,173	21,890	3,880	4,450	690
20	24,930	2,990	2,800	1,749	39,540	2,600	2,460	1,120
25	11,880	3,610	3,310	1,436	21,920	3,160	3,080	800
30	14,160	3,740	6,430	1,747	25,420	3,840	6,060	1,090
35		117,150	6,510	999		101,250	7,160	560
40		250,080	112,560	680		102,890	73,970	270
45		4,121		456		71,950		260
60								
90								
120								

Water Quality: Test 2								
Time	Turbidity (NTU)				TSS (mg/L)			
(min)	Imp. Slope	U/S Top	U/S Bot.	Disc.	Imp. Slope	U/S Top Water	U/S Bot. Water	Disc.
5	23,140	4,220	3,470	5,028	29,230	6,080	6,540	2,420
10	13,920	2,328	2,670	1,986	22,740	2,680	2,510	930
15	17,940	1,536	4,848	1,061	25,750	1,590	5,190	510
20	27,220	6,513	2,436	1,517	51,280	5,170	2,370	810
25	26,380	4,635	22,788	1,837	62,330	5,340	17,660	990
30	37,980	8,424	56,880	1,696	38,600	5,530	41,530	1,160
35		76,410	3,738	827		57,630	63,630	350
40				612		103,390		290
45								
60								
90								
120								

Water Quality: Test 3								
Time	Turbidity (NTU)				TSS (mg/L)			
(min)	Imp. Slope	U/S Top Water	U/S Bot. Water	Disc.	Imp. Slope	U/S Top Water	U/S Bot. Water	Disc.
5	10,040	5,125		4,503	13,890	4,540		1,280
10	12,750	2,328	2,811	1,224	19,270	2,450	2,330	740
15	7,170	2,211	3,519	1,151	20,470	1,910	2,270	680
20	57,420	3,666	2,814	1,504	79,440	3,250	2,410	570
25	28,160	2,313	2,709	1,201	34,760	2,050	2,060	490
30	22,650	8,676	2,643	1,275	27,610	5,230	1,830	790
35		2,727		942		2,460		530
40				904				440
45				815				470
60								
90								
120								

Pre-Test	During Test (Second)	Post-Test
		
Location 1	Location 1	Location 1
		
Location 2	Location 2	Location 2
		
Location 3	Location 3	Location 3
		
Location 4	Location 4	Location 4
		
Location 5	Location 5	Location 5

<b>Installation:</b>	I16-SW-M1
<b>Description:</b>	Straw Wattle Stapled
<b>Modification(s):</b>	Staples every foot, no stakes

<b>Impoundment Data</b>						
<b>Time</b>	<b>Test 1</b>		<b>Test 2</b>		<b>Test 3</b>	
<b>(min)</b>	<b>Depth (in)</b>	<b>Length (in)</b>	<b>Depth (in)</b>	<b>Length (in)</b>	<b>Depth (in)</b>	<b>Length (in)</b>
5	1.25	66	3	62	3.875	74
10	2.25	74	3.75	68	4.75	80
15	2.5	76	4	70	4.825	84
20	2.75	78	4.25	68	5	78
25	2.825	80	4.5	68	5.125	78
30	3	78	4.625	68	5.25	74
35	1	60	2.5	62	3	68
40	0.5	58	1	58	2	64
45	0	0	0.75	56	1.25	54
60			0	0	0	0
90						
120						

<b>Average Water Quality</b>								
<b>Time</b>	<b>Turbidity (NTU)</b>				<b>TSS (mg/L)</b>			
<b>(min)</b>	<b>Imp. Slope</b>	<b>U/S Top Water</b>	<b>U/S Bot. Water</b>	<b>Disc.</b>	<b>Imp. Slope</b>	<b>U/S Top Water</b>	<b>U/S Bot. Water</b>	<b>Disc.</b>
5	8,660	6,078	3,569	3,080	48,003	4,812	2,993	2,450
10	13,057	3,654	4,863	1,999	48,357	3,097	3,843	1,543
15	20,307	3,269	5,534	2,306	38,957	2,312	4,255	1,575
20	13,210	5,836	3,955	2,347	24,417	4,098	3,092	1,548
25	15,937	7,296	3,673	2,614	23,793	5,620	2,788	1,693
30	26,133	4,978	4,480	3,290	55,000	3,740	3,375	1,887
35		6,145	3,786	1,104		3,248	3,000	648
40		21,910		1,147				708
45				1,496				960
60								
90								
120								
<b>Average</b>	16,217	7,396	4,266	2,154	39,754	3,847	3,335	1,446
















<b>Observations</b>
Impounded runoff, but overtopped at joints between wattles. 77.2% capture upstream. 4.2% recovered from catch basin



Water Quality: Test 1								
Time	Turbidity (NTU)				TSS (mg/L)			
(min)	Imp. Slope	U/S Top Water	U/S Bot. Water	Disc.	Imp. Slope	U/S Top Water	U/S Bot. Water	Disc.
5	7,990	2,793		2,520	20,340	2,220		2,615
10	23,960	5,571		1,777	74,100	4,505		1,335
15	21,380	3,303	8,979	1,459	40,720	2,480	6,770	1,295
20	6,500	12,456	2,358	2,030	14,960	8,020	1,720	1,690
25	5,130	15,485	2,496	2,392	14,560	11,735	1,780	1,605
30	15,530	5,385	2,691	3,796	46,270	4,060	1,750	2,090
35								
40								
45								
60								
90								
120								

Water Quality: Test 2								
Time	Turbidity (NTU)				TSS (mg/L)			
(min)	Imp. Slope	U/S Top	U/S Bot.	Disc.	Imp. Slope	U/S Top Water	U/S Bot. Water	Disc.
5		6,057	3,432	3,200	104,400	5,105	2,345	2,195
10	8,370	2,289	3,159	1,985	23,180	2,100	1,995	1,340
15	22,860	2,887	2,495	2,793	44,070	1,650	1,505	1,675
20	5,740	2,099	2,911	2,058	14,110	2,035	2,080	1,220
25	21,020	2,994	2,370	2,144	43,500	2,415	1,360	1,470
30	11,840	3,087	1,536	2,765	34,060	1,700	1,300	1,620
35		3,950	2,978	815		2,710	1,800	480
40				1,087				640
45								
60								
90								
120								

Water Quality: Test 3								
Time	Turbidity (NTU)				TSS (mg/L)			
(min)	Imp. Slope	U/S Top Water	U/S Bot. Water	Disc.	Imp. Slope	U/S Top Water	U/S Bot. Water	Disc.
5	9,330	9,384	3,705	3,519	19,270	7,110	3,640	2,540
10	6,840	3,102	6,567	2,235	47,790	2,685	5,690	1,955
15	16,680	3,618	5,127	2,666	32,080	2,805	4,490	1,755
20	27,390	2,952	6,597	2,953	44,180	2,240	5,475	1,735
25	21,660	3,408	6,153	3,307	13,320	2,710	5,225	2,005
30	51,030	6,462	9,213	3,309	84,670	5,460	7,075	1,950
35		8,340	4,593	1,393		3,785	4,200	815
40		21,910		1,207				775
45				1,496				960
60								
90								
120								

<b>Pre-Test</b>	<b>During Test (Second)</b>	<b>Post-Test</b>
		
Location 1	Location 1	Location 1
		
Location 2	Location 2	Location 2
		
Location 3	Location 3	Location 3
		
Location 4	Location 4	Location 4
		
Location 5	Location 5	Location 5

Other Relevant Photos



Notes: Overtopping at low point at joints

<b>Installation:</b>	I18-SF-M5
<b>Description:</b>	Dewatering Board w/ Adj. Post Spacing
<b>Modification(s):</b>	M4 w/ adjusted post spacing

<b>Impoundment Data</b>						
<b>Time</b>	<b>Test 1</b>		<b>Test 2</b>		<b>Test 3</b>	
<b>(min)</b>	<b>Depth (in)</b>	<b>Length (in)</b>	<b>Depth (in)</b>	<b>Length (in)</b>	<b>Depth (in)</b>	<b>Length (in)</b>
5	2	82	3.25	91	4.5	81
10	3.125	92	4.825	97	6.5	100
15	5	96	6.825	103	8	105
20	6.125	100	8.5	108	9.625	110
25	7.375	104	9.75	111	10.5	115
30	8.75	109	10.75	116	11.875	119
35	8.75	107	10.625	114	11.75	117
40	8.5	102	10.5	113		
45	8.25	101	10.325	111	11.625	110
60	8	100	10.25	105	11.5	109
90	7.25	96	9.75	104	11	106
120	6.5	91	9.25	102	10.25	103
















<b>Average Water Quality</b>								
<b>Time</b>	<b>Turbidity (NTU)</b>				<b>TSS (mg/L)</b>			
<b>(min)</b>	<b>Imp. Slope</b>	<b>U/S Top Water</b>	<b>U/S Bot. Water</b>	<b>Disc.</b>	<b>Imp. Slope</b>	<b>U/S Top Water</b>	<b>U/S Bot. Water</b>	<b>Disc.</b>
5	20,829	4,350	4,141		30,393	2,867	2,598	
10	42,770	2,633	2,817		62,243	1,678	2,467	
15	23,806	2,488	2,510		37,723	1,388	1,712	
20	20,216	2,278	3,195	4,080	27,487	1,578	2,438	3,730
25	25,550	2,686	3,336	3,614	39,457	1,630	2,730	3,030
30	27,755	2,340	3,162	3,037	38,030	1,395	1,962	2,760
35		1,847	3,450	4,529		917	2,095	4,580
40		1,941	2,756	1,651		973	1,427	1,043
45		1,888	1,856	1,907		1,032	1,132	935
60		1,392	2,002	1,678		862	1,138	825
90		1,239	1,522	1,035		672	763	580
120		1,162	1,252	1,297		703	637	670
<b>Average</b>	26,821	2,187	2,667	2,536	39,222	1,308	1,758	2,017

<b>Observations</b>
Under excessive impoundment conditions, excess flow overtopped at dewatering weir into energy dissipation splash pad. Average flow through of 0.0033 during test period

Water Quality: Test 1								
Time	Turbidity (NTU)				TSS (mg/L)			
(min)	Imp. Slope	U/S Top Water	U/S Bot. Water	Disc.	Imp. Slope	U/S Top Water	U/S Bot. Water	Disc.
5	4,758	5,823	5,823		28,430	2,670		
10	3,700	2,103	3,082		53,190	1,720	1,925	
15	24,828	1,925	2,496		34,100	1,105	1,500	
20	8,958	1,203	2,546	4,080	18,250	1,190	1,625	3,730
25	17,100	1,903	3,141	5,670	30,710	1,120	2,950	5,310
30	19,194	1,671	2,652	3,648	36,010	1,155	1,970	4,405
35		1,771	2,442	9,669		955	1,515	11,560
40		1,466	1,717	1,395		735	1,100	1,170
45		1,356	1,638			695	940	
60		1,182	1,450			570	730	
90		1,105	1,507			530	825	
120		1,115	884			555	470	

Water Quality: Test 2								
Time	Turbidity (NTU)				TSS (mg/L)			
(min)	Imp. Slope	U/S Top	U/S Bot.	Disc.	Imp. Slope	U/S Top Water	U/S Bot. Water	Disc.
5	37,010	3,840	3,528		34,070	3,440	2,705	
10	89,040	3,000	2,223		86,120	1,625	2,935	
15	12,870	2,921	2,529		17,940	1,530	1,610	
20	29,820	2,738	3,483		28,870	1,695	2,850	
25	25,270	3,542	2,991	2,511	27,720	2,155	2,185	2,190
30	49,640	3,019	3,420	2,808	44,740	1,780	1,395	2,290
35		2,052	4,437	2,162		995	1,680	1,210
40		1,912	3,984	1,907		925	1,530	915
45		1,810	2,259	1,907		850	1,680	935
60		1,583	2,754	1,678		805	1,765	825
90		1,401	1,680	1,035		675	705	580
120		1,298	1,694	1,297		590	930	670

Water Quality: Test 3								
Time	Turbidity (NTU)				TSS (mg/L)			
(min)	Imp. Slope	U/S Top Water	U/S Bot. Water	Disc.	Imp. Slope	U/S Top Water	U/S Bot. Water	Disc.
5	20,718	3,388	3,072		28,680	2,490	2,490	
10	35,570	2,795	3,147		47,420	1,690	2,540	
15	33,720	2,617	2,505		61,130	1,530	2,025	
20	21,870	2,893	3,555		35,340	1,850	2,840	
25	34,280	2,614	3,876	2,660	59,940	1,615	3,055	1,590
30	14,430	2,330	3,414	2,655	33,340	1,250	2,520	1,585
35		1,719	3,471	1,755		800	3,090	970
40		2,445	2,567			1,260	1,650	
45		2,497	1,670			1,550	775	
60		1,412	1,803			1,210	920	
90		1,212	1,379			810	760	
120		1,073	1,177			965	510	

<b>Pre-Test</b>	<b>During Test (Second)</b>	<b>Post-Test</b>
		
Location 1	Location 1	Location 1
		
Location 2	Location 2	Location 2
		
Location 3	Location 3	Location 3
		
Location 4	Location 4	Location 4
		
Location 5	Location 5	Location 5

Other Relevant Photos



Notes: Zipties tearing at post more than other installs due to flipped posts, not reaching weir under standard conditions, reduced sagging due to post spacing adjustment, flow overtopping at weir under extreme-case conditions

<b>Installation:</b>	I19-SW-M2-1
<b>Description:</b>	Teepee staking
<b>Modification(s):</b>	M1, teepee staking at joints, increased overlap

<b>Impoundment Data</b>						
<b>Time</b>	<b>Test 1</b>		<b>Test 2</b>		<b>Test 3</b>	
<b>(min)</b>	<b>Depth (in)</b>	<b>Length (in)</b>	<b>Depth (in)</b>	<b>Length (in)</b>	<b>Depth (in)</b>	<b>Length (in)</b>
5	3.625	64	5.125	77	5.5	60
10	4.5	77	5.25	76	6.25	69
15	4.75	77	5.625	75	6.25	68
20	5.125	79	5.75	70	6.375	64
25	5.25	79	5.875	68	6.375	63
30	5.375	80	6	66	6.375	60
35	2.75	60	3.75	55	4.75	54
40	1.825	50	3.5	50	4	48
45	1.25	42	3.25	46	3.75	47
60	0	0	2.5	44	2.75	45
90			1.25	40	1.75	36
120			0	0	1	32

<b>Average Water Quality</b>								
<b>Time</b>	<b>Turbidity (NTU)</b>				<b>TSS (mg/L)</b>			
<b>(min)</b>	<b>Imp. Slope</b>	<b>U/S Top Water</b>	<b>U/S Bot. Water</b>	<b>Disc.</b>	<b>Imp. Slope</b>	<b>U/S Top Water</b>	<b>U/S Bot. Water</b>	<b>Disc.</b>
5	33,917	31,763	11,225	6,356	31,737	8,192	11,185	8,068
10	32,684	6,639	12,165	4,206	34,668	5,315	10,868	4,247
15	44,059	6,253	10,258	3,863	46,787	5,507	8,912	3,925
20	18,909	6,772	9,808	4,830	21,723	6,685	9,557	3,612
25	25,453	5,650	13,183	5,149	20,583	4,673	12,087	3,245
30	15,149	7,666	11,166	5,140	20,130	6,505	11,587	4,472
35		14,068	14,947	4,906		10,007	10,678	4,952
40		24,300	15,784	2,246		14,157	13,070	2,230
45		46,420	5,315	1,871		47,020	4,358	1,120
60		26,290	4,671			9,205	3,840	
90								
120								
<b>Average</b>	28,362	17,582	10,852	4,285	29,271	11,727	9,614	3,986
















<b>Observations</b>
Overtopped at section in wattle with low spot, wattles were inconsistent in diameter along their length. Average flow through rate of 0.056 ft <sup>3</sup> /s during test period. 72.1% sediment capture upstream. 4.6% sediment recovered from catch basin



Water Quality: Test 1								
Time	Turbidity (NTU)				TSS (mg/L)			
(min)	Imp. Slope	U/S Top Water	U/S Bot. Water	Disc.	Imp. Slope	U/S Top Water	U/S Bot. Water	Disc.
5	58,830	6,980		6,480	47,930	9,240		12,910
10	48,825	6,450	5,615	5,045	77,870	5,640	12,220	8,460
15	32,240	4,400	4,320	4,185	39,500	3,805	7,890	5,360
20	21,210	5,170	4,925	3,820	30,210	5,245	9,850	7,270
25	31,910	5,260	6,875	4,605	11,990	5,500	12,450	4,500
30	26,960	5,630	6,425	3,120	28,500	5,420	13,550	6,090
35		14,425		3,585		4,910		8,710
40		41,880		2,450		5,375		4,560
45				2,315				1,880
60								
90								
120								

Water Quality: Test 2								
Time	Turbidity (NTU)				TSS (mg/L)			
(min)	Imp. Slope	U/S Top	U/S Bot.	Disc.	Imp. Slope	U/S Top Water	U/S Bot. Water	Disc.
5	13,542	77,808	12,030	7,452	21,140	7,115	15,755	8,225
10	24,558	5,844	15,380	3,282	24,880	3,840	10,925	2,480
15	16,056	8,166	13,740	3,516	45,810	8,195	9,765	3,995
20	4,098	7,488	19,373	5,166	11,030	9,780	14,890	2,460
25	2,448	5,592	22,848	5,502	5,630	5,480	16,935	4,095
30	4,488	6,210	14,502	5,634	16,290	7,185	13,590	4,745
35		19,878	16,134	8,622		22,035	11,795	5,350
40		18,570	13,542	2,834		30,005	11,590	1,695
45		70,380	5,220	1,672		76,890	5,190	835
60								
90								
120								

Water Quality: Test 3								
Time	Turbidity (NTU)				TSS (mg/L)			
(min)	Imp. Slope	U/S Top Water	U/S Bot. Water	Disc.	Imp. Slope	U/S Top Water	U/S Bot. Water	Disc.
5	29,380	10,500	10,419	5,136	26,140	8,220	6,615	3,070
10	24,670	7,623	15,500	4,290	1,255	6,465	9,460	1,800
15	83,880	6,192	12,715	3,888	55,050	4,520	9,080	2,420
20	31,420	7,659	5,125	5,505	23,930	5,030	3,930	1,105
25	42,000	6,099	9,825	5,340	44,130	3,040	6,875	1,140
30	14,000	11,157	12,570	6,666	15,600	6,910	7,620	2,580
35		7,902	13,760	2,511		3,075	9,560	795
40		12,450	18,025	1,455		7,090	14,550	435
45		22,460	5,410	1,625		17,150	3,525	645
60		26,290	4,671			9,205	3,840	
90								
120								

Pre-Test	During Test (Second)	Post-Test
		
Location 1	Location 1	Location 1
		
Location 2	Location 2	Location 2
		
Location 3	Location 3	Location 3
		
Location 4	Location 4	Location 4
		
Location 5	Location 5	Location 5

Other Relevant Photos



Notes: Overtopping at maximum height of wattles

<b>Installation:</b>	I20-SF-M5-2
<b>Description:</b>	Dewatering Board w/ Adj. Post Spacing
<b>Modification(s):</b>	M4 w/ adjusted post spacing

<b>Impoundment Data</b>						
<b>Time</b>	<b>Test 1</b>		<b>Test 2</b>		<b>Test 3</b>	
<b>(min)</b>	<b>Depth (in)</b>	<b>Length (in)</b>	<b>Depth (in)</b>	<b>Length (in)</b>	<b>Depth (in)</b>	<b>Length (in)</b>
5	2.5	84	3.75	79	3.75	64
10	4	90	4.5	94	5.75	95
15	5.75	94	6.25	101	7	104
20	6.75	99	8.125	103	8.25	106
25	7.875	104	9	107	9.75	110
30	9	109	10	109	10.875	115
35	8.75	100	9.75	103	10.625	111
40	8.5	96	9.625	100	10.375	108
45	8.25	95	9.5	98	10.125	106
60	7.75	92	8.75	96	10	101
90	6.75	89	8	92	9	96
120	5	86	7	90	8.375	93
















<b>Average Water Quality</b>								
<b>Time</b>	<b>Turbidity (NTU)</b>				<b>TSS (mg/L)</b>			
<b>(min)</b>	<b>Imp. Slope</b>	<b>U/S Top Water</b>	<b>U/S Bot. Water</b>	<b>Disc.</b>	<b>Imp. Slope</b>	<b>U/S Top Water</b>	<b>U/S Bot. Water</b>	<b>Disc.</b>
5	5,787	3,745	7,108		16,170	3,736	6,395	
10	9,023	3,066	8,530	8,840	13,918	1,681	6,876	13,060
15	18,110	3,866	7,422	6,120	30,992	1,718	5,661	6,880
20	16,300	2,741	6,047	4,930	24,052	7,934	4,742	4,540
25	17,165	3,518	5,225	3,640	25,906	22,038	4,465	2,480
30	9,078	3,041	4,660	7,110	7,802	1,575	4,302	3,567
35		2,469	4,645	3,870		1,072	3,367	2,466
40		2,405	3,400	4,085		1,081	2,296	1,693
45		2,392	2,795	2,286		908	1,888	1,822
60		2,154	2,607	2,597		821	1,210	1,808
90		1,932	2,664			589	1,492	
120		1,609	2,285			576	1,188	
<b>Average</b>	<b>12,577</b>	<b>2,745</b>	<b>4,782</b>	<b>4,831</b>	<b>19,807</b>	<b>3,644</b>	<b>3,657</b>	<b>4,257</b>

<b>Observations</b>
Same as I18. 81.6% Sediment Capture Upstream. Average flow rate into catch basin of 0.00135 ft <sup>3</sup> /s during test period

Water Quality: Test 1								
Time	Turbidity (NTU)				TSS (mg/L)			
(min)	Imp. Slope	U/S Top Water	U/S Bot. Water	Disc.	Imp. Slope	U/S Top Water	U/S Bot. Water	Disc.
5	8,120	4,725	5,250		11,850	3,370	5,420	
10	4,950	4,350	5,900	8,840	8,540	1,490	4,000	13,060
15	8,050	6,520	7,675	6,120	12,660	2,910	6,430	6,880
20	16,215	3,680	7,750	4,930	2,540	16,920	4,850	4,540
25	30,120	5,690	7,045	3,640	2,080	48,280	5,110	2,480
30	18,270	3,865	6,050	9,220	1,390	1,580	5,710	4,010
35		3,623	4,445	4,870		1,280	3,070	1,980
40		3,027	4,130	4,480		1,390	3,010	1,310
45		2,950	3,425	2,220		1,100	2,350	2,110
60		3,035	3,335	2,560		1,010	1,320	2,010
90		2,738	3,789			800	1,900	
120		2,242	2,994			640	1,390	

Water Quality: Test 2								
Time	Turbidity (NTU)				TSS (mg/L)			
(min)	Imp. Slope	U/S Top	U/S Bot.	Disc.	Imp. Slope	U/S Top Water	U/S Bot. Water	Disc.
5	6,740	3,445	4,315		14,060	4,500	8,135	
10	7,420	2,255	5,460			1,885	10,525	
15	21,350	2,545	5,180		39,360	475	5,535	
20	6,765	2,765	6,210		38,340	515	4,760	
25	8,085	2,815	4,580		50,740	950	4,135	
30	3,295	2,955	5,140	8,335	11,360		3,150	3,320
35		2,250	5,070	3,925		720	3,655	2,930
40		2,662	3,600	3,690		740	1,590	
45		2,321	2,765	2,352		650	1,420	
60		2,268	2,560	2,634		610	1,010	
90		2,040	2,245			525	1,150	
120		1,615	2,325			495	980	

Water Quality: Test 3								
Time	Turbidity (NTU)				TSS (mg/L)			
(min)	Imp. Slope	U/S Top Water	U/S Bot. Water	Disc.	Imp. Slope	U/S Top Water	U/S Bot. Water	Disc.
5	2,500	3,065	11,760		22,600	3,338	5,630	
10	14,700	2,592	14,230		19,295	1,667	6,102	13,060
15	24,930	2,534	9,410		40,957	1,770	5,017	6,880
20	25,920	1,777	4,180		31,277	6,368	4,617	4,540
25	13,290	2,049	4,050		24,897	16,885	4,150	2,480
30	5,670	2,302	2,790	3,775	10,657	1,570	4,045	3,370
35		1,535	4,420	2,815		1,215	3,375	2,487
40		1,527	2,469			1,113	2,288	2,075
45		1,904	2,195			975	1,893	1,535
60		1,158	1,926			843	1,300	1,605
90		1,018	1,958			442	1,425	
120		969	1,536			593	1,193	

<b>Pre-Test</b>	<b>During Test (Second)</b>	<b>Post-Test</b>
		
Location 1	Location 1	Location 1
		
Location 2	Location 2	Location 2
		
Location 3	Location 3	Location 3
		
Location 4	Location 4	Location 4
		
Location 5	Location 5	Location 5

<b>Installation:</b>	I20-SF-M5-3
<b>Description:</b>	Dewatering Board w/ Adj. Post Spacing
<b>Modification(s):</b>	M4 w/ adjusted post spacing

### Impoundment Data

Time (min)	Test 1		Test 2		Test 3	
	Depth (in)	Length (in)	Depth (in)	Length (in)	Depth (in)	Length (in)
5	1.75	83	3.125	77	3.625	74
10	3.5	90	4.25	83	5.5	85
15	5.25	92	7	101	7.25	1001
20	7	101	8.5	106	8.375	107
25	8.375	104	9.5	111	9.75	112
30	10	110	10.5	114	10.875	114
35	9.75	108	10.25	109	10.875	113
40	9.375	105	10	106	10.625	110
45	9.25	1014	9.875	102	10.325	108
60	8.75	98	9.75	99	10	102
90	8	94	9.25	96	9	96
120	7.5	92	8.5	93	8.375	92

### Average Water Quality

Time (min)	Turbidity (NTU)					TSS (mg/L)				
	Imp. Slope	U/S Top Water	U/S Bot. Water	DWB	Disc.	Imp. Slope	U/S Top Water	U/S Bot. Water	DWB	Disc.
5	43,485	7,443	6,205			50,330	5,895	5,623	1,329	
10	23,420	4,110	7,747	4,117	10,610	25,685	3,285	6,634	3,590	11,380
15	21,725	4,250	6,342	3,305		26,285	3,500	5,712	3,008	
20	41,360	3,466	7,513	3,704	5,360	46,150	2,656	6,268	3,255	4,250
25	41,115	3,256	8,522	3,327		41,520	2,409	6,582	3,016	
30	23,310	2,755	6,185	3,294			1,982	5,773	2,888	
35		2,335	5,373	2,639			1,299	4,600	2,250	
40		2,424	4,571	2,666			1,618	3,977	2,282	
45		2,093	3,162	2,675			1,354	2,414	2,264	
60		1,833	2,816	2,327	5,364		1,145	2,157	2,001	2,500
90		1,298	2,955	1,925			980	2,204	1,672	
120		1,500	2,371	1,832			960	1,744	1,579	
<b>Average</b>	<b>32,403</b>	<b>3,064</b>	<b>5,313</b>	<b>2,892</b>	<b>7,111</b>	<b>37,994</b>	<b>2,257</b>	<b>4,474</b>	<b>2,428</b>	<b>6,043</b>

### Observations
















No energy dissipating splash pad was installed to allow for sampling of flow through dewatering board. Average flow of 0.0056 ft<sup>3</sup>/s into catch basin during test period. During first test period, the three holes were reached 8.5, 19.25, and 28.5 into the test. Second 5.5, 13.5, 25 min. Third 3.25, 12, 22.3 min.

Water Quality: Test 1										
Time	Turbidity (NTU)					TSS (mg/L)				
(min)	Imp. Slope	U/S Top Water	U/S Bot. Water	DWB	Disc.	Imp. Slope	U/S Top Water	U/S Bot. Water	DWB	Disc.
5	76,460	10,985	5,105			90,150	6,340	3,360		
10	31,840	7,705	7,280	4,880	10,610	36,370	5,230	3,940	4,880	11,380
15	15,470	5,640	7,400	4,620		24,590	3,390	5,510	4,620	
20	27,520	4,940	8,665	4,740	5,360	37,100	2,510	4,930	4,740	4,250
25	11,490	4,340	10,930	4,150		12,300	1,800	5,110	4,150	
30	23,310	3,740	5,605	4,220			1,420	4,370	4,220	
35		3,846	5,380	4,021			740	3,060	4,021	
40		3,647	4,060	3,717			1,230	2,280	3,717	
45		3,438	3,834	3,533			1,220	1,590	3,533	
60		2,942	3,498	3,337	5,364		880	1,520	3,337	2,500
90		2,792	3,571	2,616			860	1,320	2,616	
120		2,490	2,941	2,599			870	1,060	2,599	

Water Quality: Test 2										
Time	Turbidity (NTU)					TSS (mg/L)				
(min)	Imp. Slope	U/S Top	U/S Bot.	DWB	Disc.	Imp. Slope	U/S Top Water	U/S Bot. Water	DWB	Disc.
5	10,510	3,714	4,176			13,770	2,610	3,065		
10	15,000	2,510	2,916	3,354		13,010	1,240	2,295	2,715	
15	27,980	4,034	4,065	1,989		37,890	2,450	3,270	1,390	
20	55,200	2,974	3,183	2,668		57,200	1,630	2,385	1,740	
25	70,740	2,789	4,791	2,504		31,730	1,495	3,715	1,290	
30		2,630	3,834	2,368			1,335	2,830	1,040	
35		1,897	4,950	1,257			845	3,870	620	
40		1,911	2,472	1,615			955	1,990	635	
45		1,617	1,725	1,817			705	1,220	1,455	
60		1,364	1,494	1,316			545	985	545	
90		-	1,586	1,233				840	455	
120		1,098	1,326	1,065			395	580	420	

Water Quality: Test 3										
Time	Turbidity (NTU)					TSS (mg/L)				
(min)	Imp. Slope	U/S Top Water	U/S Bot. Water	DWB	Disc.	Imp. Slope	U/S Top Water	U/S Bot. Water	DWB	Disc.
5		7,630	9,333	1,329			6,110	3,470	800	
10		2,115	13,045	2,536			1,420	5,400	1,520	
15		3,077	7,560	2,415			1,940	5,120	1,330	
20		2,483	10,690	2,356			1,420	8,300	1,110	
25		2,639	9,845	2,393			1,480	2,920	1,160	
30		1,896	9,115	2,077			1,040	6,020	1,070	
35		1,261	5,790	1,472			130	3,860	640	
40		1,714	7,180	1,513			860	6,110	680	
45		1,224	3,926	1,442			570	2,880	590	
60		1,192	3,456	1,349			600	2,490	590	
90		1,101	3,707	1,168			470	2,700	510	
120		913	2,847	1,074			390	2,620	500	



Pre-Test	During Test (Second)	Post-Test
		
Location 1	Location 1	Location 1
		
Location 2	Location 2	Location 2
		
Location 3	Location 3	Location 3
		
Location 4	Location 4	Location 4
		
Location 5	Location 5	Location 5

Other Relevant Photos



Notes: Flow through dewatering board holes and scour caused by lack of energy dissipation device

<b>Installation:</b>	I22-SW-M2-2
<b>Description:</b>	Teepee staking
<b>Modification(s):</b>	M1, teepee staking at joints, increased overlap

<b>Impoundment Data</b>						
<b>Time</b>	<b>Test 1</b>		<b>Test 2</b>		<b>Test 3</b>	
<b>(min)</b>	<b>Depth (in)</b>	<b>Length (in)</b>	<b>Depth (in)</b>	<b>Length (in)</b>	<b>Depth (in)</b>	<b>Length (in)</b>
5	3	60	4.5	74	5.25	85
10	3.5	74	5	82	6.5	94
15	38.25	76	5.25	86	6.75	96
20	4.25	82	5.5	94	6.75	98
25	5	88	6	92	6.825	96
30	5.175	92	6.125	88	7	93
35	1.5	55	3.125	62	5.125	80
40	1	40	2.125	50	4.5	68
45	0.5	35	1	40	4	60
60	0	0	0.5	32	3	48
90			0	0	2.5	40
120					2	34
















<b>Average Water Quality</b>								
<b>Time</b>	<b>Turbidity (NTU)</b>				<b>TSS (mg/L)</b>			
	<b>Imp. Slope</b>	<b>U/S Top Water</b>	<b>U/S Bot. Water</b>	<b>Disc.</b>	<b>Imp. Slope</b>	<b>U/S Top Water</b>	<b>U/S Bot. Water</b>	<b>Disc.</b>
5	23,177	8,332	6,343	2,709	35,780	6,210	5,288	2,712
10	52,700	8,592	7,269	5,804	87,777	6,757	5,332	3,948
15	30,830	6,387	5,488	4,120	51,940	5,258	4,002	3,050
20	22,033	6,191	7,040	4,530	41,210	4,727	5,148	3,350
25	56,283	5,317	4,999	3,359	83,987	4,242	3,827	2,990
30	34,960	5,731	6,394	4,331	51,227	4,535	4,705	2,722
35		27,675	4,240	2,124		52,767	2,658	1,075
40		8,521	3,266	1,827		1,600	2,320	845
45		3,131	4,527			3,890	3,985	
60		4,665	2,430			3,750	1,270	
90								
120								
<b>Average</b>	36,664	8,454	5,200	3,601	58,653	9,374	3,853	2,586

<b>Observations</b>
Overtopped during final test. Average flow through rate of 0.059 ft <sup>3</sup> /s during testing period. 86.4% sediment capture upstream of installation. 2% of sediment recovered in catch basin.

Water Quality: Test 1								
Time	Turbidity (NTU)				TSS (mg/L)			
(min)	Imp. Slope	U/S Top Water	U/S Bot. Water	Disc.	Imp. Slope	U/S Top Water	U/S Bot. Water	Disc.
5	16,310	9,399	5,130	2,842	30,470	7,930	4,425	3,720
10	50,420	12,530	8,640	9,621	113,190	10,755	6,890	7,350
15	47,280	9,110	5,334	4,776	74,590	8,100	4,045	3,605
20	20,260	8,295	10,593	5,946	38,430	7,040	7,355	4,185
25	30,260	6,390	4,068	2,700	54,730	5,285	3,145	3,320
30	53,900	6,970	9,459	3,816	68,480	5,995	7,065	2,590
35		69,180		1,703		147,360		925
40								
45								
60								
90								
120								

Water Quality: Test 2								
Time	Turbidity (NTU)				TSS (mg/L)			
(min)	Imp. Slope	U/S Top	U/S Bot.	Disc.	Imp. Slope	U/S Top Water	U/S Bot. Water	Disc.
5	40,260	3,594	7,302	1,146	55,920	2,700	6,390	1,910
10	82,700	6,306	4,971	3,628	93,700	4,495	3,500	2,215
15	24,450	5,013	5,847	4,051	35,170	4,245	4,330	3,015
20	21,680	4,191	4,863	3,816	39,570	2,800	3,085	3,495
25	106,110	3,900	3,774	4,018	134,140	2,675	2,580	2,660
30	43,120	3,012	2,820	3,915	70,820	2,395	1,860	2,270
35		10,986	3,442	2,215		8,470	1,810	1,150
40		13,962	2,395	1,378		1,875	1,850	710
45								
60								
90								
120								

Water Quality: Test 3								
Time	Turbidity (NTU)				TSS (mg/L)			
(min)	Imp. Slope	U/S Top Water	U/S Bot. Water	Disc.	Imp. Slope	U/S Top Water	U/S Bot. Water	Disc.
5	12,960	12,003	6,597	4,140	20,950	8,000	5,050	2,505
10	24,980	6,939	8,196	4,164	56,440	5,020	5,605	2,280
15	20,760	5,037	5,283	3,534	46,060	3,430	3,630	2,530
20	24,160	6,087	5,664	3,828	45,630	4,340	5,005	2,370
25	32,480	5,661	7,155		63,090	4,765	5,755	
30	7,860	7,212	6,903	5,262	14,380	5,215	5,190	3,305
35		2,859	5,037	2,454		2,470	3,505	1,150
40		3,079	4,137	2,275		1,325	2,790	980
45		3,131	4,527			3,890	3,985	
60		4,665	2,430			3,750	1,270	
90								
120								

<b>Pre-Test</b>	<b>During Test (Second)</b>	<b>Post-Test</b>
		
Location 1	Location 1	Location 1
		
Location 2	Location 2	Location 2
		
Location 3	Location 3	Location 3
		
Location 4	Location 4	Location 4
		
Location 5	Location 5	Location 5

Other Relevant Photos



Notes: Installation overtopping under standard conditions

<b>Installation:</b>	I23-SW-M2-3
<b>Description:</b>	Teepee staking
<b>Modification(s):</b>	M1, teepee staking at joints, increased overlap

<b>Impoundment Data</b>						
<b>Time</b>	<b>Test 1</b>		<b>Test 2</b>		<b>Test 3</b>	
<b>(min)</b>	<b>Depth (in)</b>	<b>Length (in)</b>	<b>Depth (in)</b>	<b>Length (in)</b>	<b>Depth (in)</b>	<b>Length (in)</b>
5	3.5	46	5.25	63	5.5	76
10	4.25	60	6	70	6.125	90
15	4.875	66	6.25	74	6.25	88
20	5	72	6.25	78	6.5	82
25	5.25	74	6.375	82	6.25	76
30	5.375	78	6.375	85	6.25	74
35	1.5	34	3.625	60	4.25	58
40	1	26	2.25	40	3	44
45	0	0	2	32	2.5	28
60			0.75	20	0.5	24
90			0	0	0	0
120						

<b>Average Water Quality</b>								
<b>Time</b>	<b>Turbidity (NTU)</b>				<b>TSS (mg/L)</b>			
<b>(min)</b>	<b>Imp. Slope</b>	<b>U/S Top Water</b>	<b>U/S Bot. Water</b>	<b>Disc.</b>	<b>Imp. Slope</b>	<b>U/S Top Water</b>	<b>U/S Bot. Water</b>	<b>Disc.</b>
5	13,095	11,607	13,210	8,286	11,183	7,503	6,837	6,270
10	17,932	8,720	62,507	7,729	16,473	5,917	42,837	3,417
15	25,593	8,167	42,749	6,584	29,083	5,263	47,943	3,360
20	26,987	7,187	47,276	5,651	23,347	4,363	34,893	3,150
25	18,163	7,628	18,066	8,429	19,440	4,427	14,150	3,993
30	5,192	7,660	22,912	6,747	6,397	4,520	11,110	3,767
35		6,131	12,513	4,661		34,310	15,027	1,766
40			5,492	5,286			2,600	3,250
45			60,420				48,800	
60								
90								
120								
<b>Average</b>	<b>17,827</b>	<b>8,157</b>	<b>31,683</b>	<b>6,671</b>	<b>17,654</b>	<b>9,472</b>	<b>24,911</b>	<b>3,622</b>
















<b>Observations</b>
Same as other Straw Wattle M2 installs. Average flow through rate of 0.062 ft <sup>3</sup> /s during test period. 83.9% sediment capture upstream. 5.0% sediment recovered in catch basin

Water Quality: Test 1								
Time	Turbidity (NTU)				TSS (mg/L)			
(min)	Imp. Slope	U/S Top Water	U/S Bot. Water	Disc.	Imp. Slope	U/S Top Water	U/S Bot. Water	Disc.
5	4,955	9,075	11,930	7,350	9,020	5,950	8,190	5,240
10	5,265	10,115	9,995	9,100	8,600	7,130	7,940	4,520
15	41,030	9,400	8,875	8,325	42,850	6,480	7,780	4,960
20	13,450	6,015	11,205	5,930	13,380	4,620	7,750	4,000
25	19,040	7,150	12,995	6,185	17,820	4,420	8,580	4,250
30	4,805	8,590	15,635	7,945	7,080	6,000	4,770	5,040
35			6,210	4,435			10,820	2,309
40								
45								
60								
90								
120								

Water Quality: Test 2								
Time	Turbidity (NTU)				TSS (mg/L)			
(min)	Imp. Slope	U/S Top	U/S Bot.	Disc.	Imp. Slope	U/S Top Water	U/S Bot. Water	Disc.
5	11,480	11,721	14,490	8,960	12,120	6,680	6,090	3,820
10	33,510	7,044	13,905	8,900	27,780	3,930	9,350	3,340
15	11,410	6,126	10,773	5,325	15,510	3,420	9,260	1,930
20	36,900	7,083	8,703	5,400	29,820	3,530	6,850	2,500
25	6,700	7,620	9,552	13,395	6,790	4,100	5,580	4,390
30	8,230	6,222	21,300	6,550	8,140	3,480	5,150	2,830
35		6,213	18,815	5,735		3,260	13,730	1,120
40			7,833					
45								
60								
90								
120								

Water Quality: Test 3								
Time	Turbidity (NTU)				TSS (mg/L)			
(min)	Imp. Slope	U/S Top Water	U/S Bot. Water	Disc.	Imp. Slope	U/S Top Water	U/S Bot. Water	Disc.
5	22,850	14,025		8,547	12,410	9,880	6,230	9,750
10	15,020	9,000	163,620	5,187	13,040	6,690	111,220	2,390
15	24,340	8,976	108,600	6,102	28,890	5,890	126,790	3,190
20	30,610	8,463	121,920	5,622	26,840	4,940	90,080	2,950
25	28,750	8,115	31,650	5,706	33,710	4,760	28,290	3,340
30	2,540	8,169	31,800	5,745	3,970	4,080	23,410	3,430
35		6,048		3,813		65,360	20,530	1,870
40			3,150	5,286			2,600	3,250
45			60,420				48,800	
60								
90								
120								



Pre-Test	During Test (Second)	Post-Test
		
Location 1	Location 1	Location 1
		
Location 2	Location 2	Location 2
		
Location 3	Location 3	Location 3
		
Location 4	Location 4	Location 4
		
Location 5	Location 5	Location 5

Other Relevant Photos



Notes: Installation reaching max impoundment height

<b>Installation:</b>	I24-EW-1
<b>Description:</b>	Excelsior Wattle MFEI
<b>Modification(s):</b>	Same as Straw Wattle M2

<b>Impoundment Data</b>						
<b>Time</b>	<b>Test 1</b>		<b>Test 2</b>		<b>Test 3</b>	
<b>(min)</b>	<b>Depth (in)</b>	<b>Length (in)</b>	<b>Depth (in)</b>	<b>Length (in)</b>	<b>Depth (in)</b>	<b>Length (in)</b>
5	1.5	36	2.375	60	2.5	48
10	1.625	44	2.5	72	3.125	56
15	1.75	48	2.75	80	3.5	60
20	2	50	3	82	3.625	54
25	2.25	54	3.125	78	3.875	50
30	2.625	58	3.25	76	4	48
35	0.75	38	2	53	2.75	44
40	0.25	30	1.75	46	2.25	38
45	0.125	24	1.625	38	2.125	36
60	0	0	1.25	36	1.75	34
90			0.5	28	0.75	30
120			0	0	0	0









<b>Average Water Quality</b>								
<b>Time</b>	<b>Turbidity (NTU)</b>				<b>TSS (mg/L)</b>			
<b>(min)</b>	<b>Imp. Slope</b>	<b>U/S Top Water</b>	<b>U/S Bot. Water</b>	<b>Disc.</b>	<b>Imp. Slope</b>	<b>U/S Top Water</b>	<b>U/S Bot. Water</b>	<b>Disc.</b>
5	21,197	13,502	20,720	8,927	33,983	14,570	16,505	4,387
10	15,490	20,572	10,628	7,698	25,480	11,327	8,230	4,580
15	32,157	34,958	18,575	7,666	56,320	35,280	14,080	7,020
20	26,473	19,840	19,117	9,210	32,897	20,017	15,563	5,707
25	20,267	19,182	18,158	7,029	29,450	22,617	14,970	3,993
30	24,497	29,053	8,418	9,939	73,667	38,117	6,383	4,223
35		36,563	5,125	2,627		25,890	3,535	1,870
40		40,785	8,940	863			2,230	490
45			6,540				2,400	
60								
90								
120								
<b>Average</b>	<b>23,347</b>	<b>26,807</b>	<b>12,913</b>	<b>6,745</b>	<b>41,966</b>	<b>23,974</b>	<b>9,322</b>	<b>4,034</b>

<b>Observations</b>
Very little impoundment facilitated. Impoundment grew through test and in subsequent tests, indicating a lack of undermining. Average flow rate of 0.055 ft <sup>3</sup> /s during test period. 83.8% sediment capture upstream, 6.3% recovered from catch basin.

Water Quality: Test 1								
Time	Turbidity (NTU)				TSS (mg/L)			
(min)	Imp. Slope	U/S Top Water	U/S Bot. Water	Disc.	Imp. Slope	U/S Top Water	U/S Bot. Water	Disc.
5	28,250	12,435		12,535	46,450	11,540		3,990
10	6,270	19,465		12,020	9,000	19,790		7,710
15	31,860	53,235		16,535	22,200	59,480		11,630
20	27,600	26,050	9,460	13,418	49,070	31,180	9,500	10,350
25	21,920	28,980	31,630	7,160	34,410	45,200	27,590	5,120
30	25,800	38,560	8,940	16,950	52,970	62,750	10,080	7,810
35								
40								
45								
60								
90								
120								

Water Quality: Test 2								
Time	Turbidity (NTU)				TSS (mg/L)			
(min)	Imp. Slope	U/S Top	U/S Bot.	Disc.	Imp. Slope	U/S Top Water	U/S Bot. Water	Disc.
5	25,630	12,160	12,060	9,435	39,880	14,100	9,880	7,360
10	10,240	14,280	8,280	7,164	20,290	9,430	8,570	4,070
15	41,440	32,470	10,390	8	124,940	25,800	8,530	5,390
20	42,180	19,480	11,010	7,602	38,040	15,830	8,460	4,980
25	16,120	13,685	17,545	7,662	34,130	9,680	14,060	4,720
30	20,480	28,800	8,295	6,381	34,240	27,260	7,620	3,630
35		53,775	5,775	2,517			4,650	2,370
40								
45								
60								
90								
120								

Water Quality: Test 3								
Time	Turbidity (NTU)				TSS (mg/L)			
(min)	Imp. Slope	U/S Top Water	U/S Bot. Water	Disc.	Imp. Slope	U/S Top Water	U/S Bot. Water	Disc.
5	9,710	15,910	29,380	4,810	15,620	18,070	23,130	1,810
10	29,960	27,970	12,975	3,910	47,150	4,760	7,890	1,960
15	23,170	19,170	26,760	6,455	21,820	20,560	19,630	4,040
20	9,640	13,990	36,880	6,610	11,580	13,040	28,730	1,790
25	22,760	14,880	5,300	6,265	19,810	12,970	3,260	2,140
30	27,210	19,800	8,020	6,485	133,790	24,340	1,450	1,230
35		19,350	4,475	2,737		25,890	2,420	1,370
40		40,785	8,940	863			2,230	490
45			6,540				2,400	
60								
90								
120								

<b>Pre-Test</b>	<b>During Test (Second)</b>	<b>Post-Test</b>
		
Location 1	Location 1	Location 1
		
Location 2	Location 2	Location 2
		
Location 3	Location 3	Location 3
		
Location 4	Location 4	Location 4
		
Location 5	Location 5	Location 5

Other Relevant Photos



Notes: Lack of impoundment formed, high water line is well below even the middle of the installation

<b>Installation:</b>	I25-EW-1
<b>Description:</b>	Excelsior Wattle MFEI
<b>Modification(s):</b>	Same as Straw Wattle M2

<b>Impoundment Data</b>						
<b>Time</b>	<b>Test 1</b>		<b>Test 2</b>		<b>Test 3</b>	
<b>(min)</b>	<b>Depth (in)</b>	<b>Length (in)</b>	<b>Depth (in)</b>	<b>Length (in)</b>	<b>Depth (in)</b>	<b>Length (in)</b>
5	0.75	35	2.25	56	3	54
10	1.25	38	2.625	55	3.5	52
15	1.75	40	3	52	3.625	50
20	2	46	3.125	48	3.75	46
25	2.125	51	3.125	46	3.875	45
30	2.125	52	3.25	43	4	42
35	0.75	31	1.5	40	2.5	36
40	0.25	26	1	30	2.125	33
45	0.25	20	0.75	28	2	28
60	0	0	0.5	24	1.25	26
90			0	0	0.25	26
120					0	0

<b>Average Water Quality</b>								
<b>Time</b>	<b>Turbidity (NTU)</b>				<b>TSS (mg/L)</b>			
<b>(min)</b>	<b>Imp. Slope</b>	<b>U/S Top Water</b>	<b>U/S Bot. Water</b>	<b>Disc.</b>	<b>Imp. Slope</b>	<b>U/S Top Water</b>	<b>U/S Bot. Water</b>	<b>Disc.</b>
5	17,900	14,503	12,019	8,998	33,180	11,737	8,620	7,920
10	20,517	15,269	12,844	11,323	34,733	14,873	9,790	7,500
15	16,270	14,061	13,063	10,008	30,713	14,323	10,547	7,187
20	16,997	13,965	11,206	10,437	30,290	10,827	8,757	7,320
25	17,665	14,846	13,890	10,523	29,680	14,247	14,147	7,303
30	28,963	12,445	11,702	9,371	71,947	10,883	8,390	7,553
35		12,672	8,469	5,256		10,430	5,760	3,740
40		16,992	11,481	2,196		16,520	6,300	1,500
45		31,650	9,144	2,061			5,650	1,220
60								
90								
120								
<b>Average</b>	19,719	16,267	11,535	7,797	38,424	12,980	8,662	5,694
















<b>Observations</b>
Similar performance to I24. Average flow rate of 0.055 ft <sup>3</sup> /s during test period. 75.6% sediment capture upstream, 10.0% recovered from catch basin.

Water Quality: Test 1								
Time	Turbidity (NTU)				TSS (mg/L)			
(min)	Imp. Slope	U/S Top Water	U/S Bot. Water	Disc.	Imp. Slope	U/S Top Water	U/S Bot. Water	Disc.
5	19,550	13,968		6,381	29,120	14,580		9,530
10	36,350	22,330		16,360	44,840	22,660		11,200
15	24,370	19,820	19,180	12,190	36,660	24,930	16,190	9,230
20	22,870	22,940	12,485	11,860	40,220	20,980	11,720	9,430
25	28,400	21,870	19,584	11,295	40,270	23,980	16,870	8,930
30	37,760	21,290		10,730	141,630	20,440		9,400
35								
40								
45								
60								
90								
120								

Water Quality: Test 2								
Time	Turbidity (NTU)				TSS (mg/L)			
(min)	Imp. Slope	U/S Top	U/S Bot.	Disc.	Imp. Slope	U/S Top Water	U/S Bot. Water	Disc.
5	4,360	19,434	12,770	11,619	7,580	13,960	10,670	8,280
10	8,370	13,626	11,150	11,166	17,780	15,680	8,720	8,070
15	14,270	9,498	6,970	8,934	25,290	8,320	5,740	6,500
20	18,970	7,068	14,720	9,714	27,380	1,800	10,270	6,590
25	9,395	11,628	12,805	8,799	16,230	9,260	10,090	6,230
30	24,210	8,466	8,950	7,773	32,170	6,990	6,940	7,470
35				4,743				3,740
40				1,218				790
45								
60								
90								
120								

Water Quality: Test 3								
Time	Turbidity (NTU)				TSS (mg/L)			
(min)	Imp. Slope	U/S Top Water	U/S Bot. Water	Disc.	Imp. Slope	U/S Top Water	U/S Bot. Water	Disc.
5	29,790	10,107	11,268	8,994	62,840	6,670	6,570	5,950
10	16,830	9,852	14,538	6,444	41,580	6,280	10,860	3,230
15	10,170	12,864	13,038	8,901	30,190	9,720	9,710	5,830
20	9,150	11,886	6,414	9,738	23,270	9,700	4,280	5,940
25	15,200	11,040	9,282	11,475	32,540	9,500	15,480	6,750
30	24,920	7,578	14,454	9,609	42,040	5,220	9,840	5,790
35		12,672	8,469	5,769		10,430	5,760	3,740
40		16,992	11,481	3,174		16,520	6,300	2,210
45		31,650	9,144	2,061			5,650	1,220
60								
90								
120								



<b>Pre-Test</b>	<b>During Test (Second)</b>	<b>Post-Test</b>
		
Location 1	Location 1	Location 1
		
Location 2	Location 2	Location 2
		
Location 3	Location 3	Location 3
		
Location 4	Location 4	Location 4
		
Location 5	Location 5	Location 5

Other Relevant Photos



Notes: Visibly high flow-through rates and sediment deposition upstream

<b>Installation:</b>	I26-EW-3
<b>Description:</b>	Excelsior Wattle MFEI
<b>Modification(s):</b>	Same as Straw Wattle M2

<b>Impoundment Data</b>						
<b>Time</b>	<b>Test 1</b>		<b>Test 2</b>		<b>Test 3</b>	
<b>(min)</b>	<b>Depth (in)</b>	<b>Length (in)</b>	<b>Depth (in)</b>	<b>Length (in)</b>	<b>Depth (in)</b>	<b>Length (in)</b>
5	1.25	26	2	48	2.5	58
10	1.5	31	2.125	52	2.825	56
15	1.625	38	2.25	54	3	52
20	1.75	41	2.5	62	3.125	50
25	2.125	44	2.625	68	3.25	47
30	2.5	48	2.75	64	3.25	46
35	1	22	1.5	32	2	40
40	0.5	18	1	28	1.5	36
45	0	0	0.75	24	1	32
60			0.25	17	0.75	26
90			0	0	0	0
120						
















<b>Average Water Quality</b>								
<b>Time</b>	<b>Turbidity (NTU)</b>				<b>TSS (mg/L)</b>			
<b>(min)</b>	<b>Imp. Slope</b>	<b>U/S Top Water</b>	<b>U/S Bot. Water</b>	<b>Disc.</b>	<b>Imp. Slope</b>	<b>U/S Top Water</b>	<b>U/S Bot. Water</b>	<b>Disc.</b>
5	38,137	7,563	11,870	10,812	38,137	7,563	11,870	10,812
10	19,013	16,010	11,245	10,773	19,013	16,010	11,245	10,773
15	27,663	24,062	7,360	9,655	27,663	24,062	7,360	9,655
20	23,643	26,880	21,010	10,327	23,643	26,880	21,010	10,327
25	22,537	9,205	10,890	9,857	22,537	9,205	10,890	9,857
30	21,140	30,953	18,420	10,085	21,140	30,953	18,420	10,085
35				4,097				4,097
40				6,430				6,430
45				3,355				3,355
60								
90								
120								
<b>Average</b>	<b>25,356</b>	<b>19,112</b>	<b>13,466</b>	<b>8,377</b>	<b>25,356</b>	<b>19,112</b>	<b>13,466</b>	<b>8,377</b>

<b>Observations</b>
Similar performance to I24 and I25. Average flow rate of 0.059 ft <sup>3</sup> /s during test period. 65.5% sediment capture upstream, 7.7% recovered from catch basin.

Water Quality: Test 1								
Time	Turbidity (NTU)				TSS (mg/L)			
(min)	Imp. Slope	U/S Top Water	U/S Bot. Water	Disc.	Imp. Slope	U/S Top Water	U/S Bot. Water	Disc.
5	44,055			11,455	44,055			11,455
10	19,480	9,725		7,325	19,480	9,725		7,325
15	17,410	22,510		10,090	17,410	22,510		10,090
20	20,470	56,160		9,015	20,470	56,160		9,015
25	20,300	15,015		7,815	20,300	15,015		7,815
30	25,650	38,220		8,390	25,650	38,220		8,390
35				3,120				3,120
40								
45								
60								
90								
120								

Water Quality: Test 2								
Time	Turbidity (NTU)				TSS (mg/L)			
(min)	Imp. Slope	U/S Top	U/S Bot.	Disc.	Imp. Slope	U/S Top Water	U/S Bot. Water	Disc.
5	27,020	8,375		7,505	27,020	8,375		7,505
10	21,570	6,515		8,380	21,570	6,515		8,380
15	27,970	8,825		3,830	27,970	8,825		3,830
20	10,850	7,880	30,370	6,115	10,850	7,880	30,370	6,115
25	18,160	6,540	4,600	6,015	18,160	6,540	4,600	6,015
30	18,140	11,980		6,090	18,140	11,980		6,090
35				3,682				3,682
40								
45								
60								
90								
120								

Water Quality: Test 3								
Time	Turbidity (NTU)				TSS (mg/L)			
(min)	Imp. Slope	U/S Top Water	U/S Bot. Water	Disc.	Imp. Slope	U/S Top Water	U/S Bot. Water	Disc.
5	43,335	6,750	11,870	13,475	43,335	6,750	11,870	13,475
10	15,990	31,790	11,245	16,615	15,990	31,790	11,245	16,615
15	37,610	40,850	7,360	15,045	37,610	40,850	7,360	15,045
20	39,610	16,600	11,650	15,850	39,610	16,600	11,650	15,850
25	29,150	6,060	17,180	15,740	29,150	6,060	17,180	15,740
30	19,630	42,660	18,420	15,775	19,630	42,660	18,420	15,775
35				5,490				5,490
40				6,430				6,430
45				3,355				3,355
60								
90								
120								

<b>Pre-Test</b>	<b>During Test (Second)</b>	<b>Post-Test</b>
		
Location 1	Location 1	Location 1
		
Location 2	Location 2	Location 2
		
Location 3	Location 3	Location 3
		
Location 4	Location 4	Location 4
		
Location 5	Location 5	Location 5

Other Relevant Photos

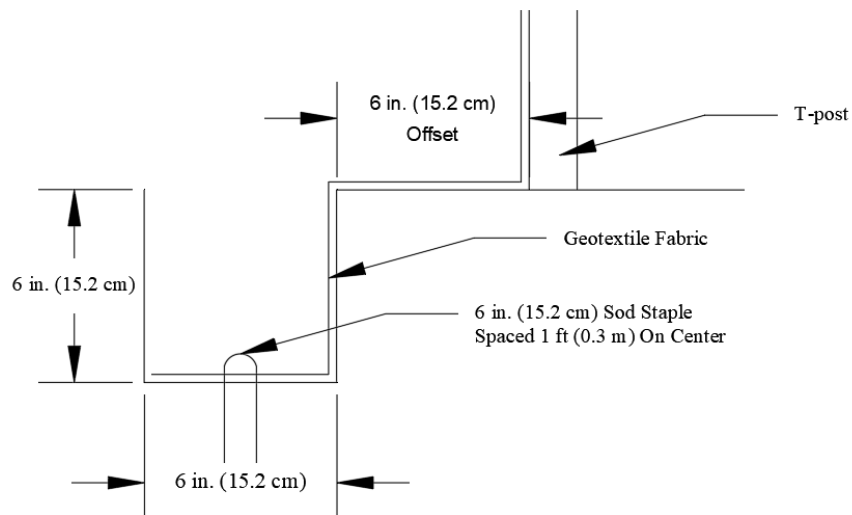


Notes: Lack of impoundment formed under an extreme case simulated stormwater runoff event

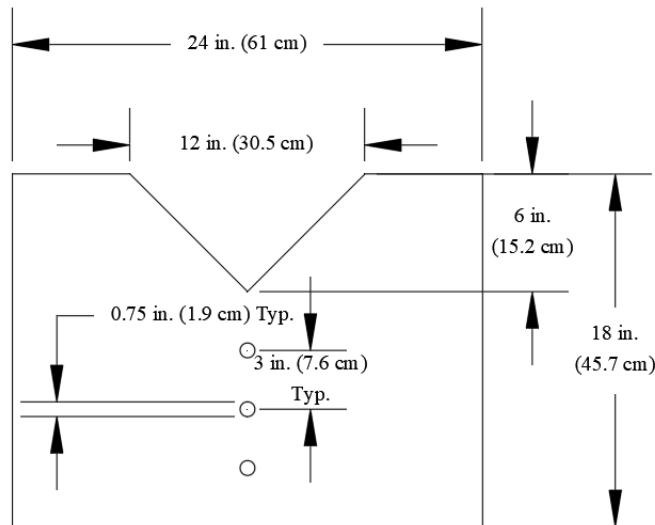
## Appendix C: Sediment Barrier Specifications

### Silt Fence Specifications

- 36 in. (91.4 cm) woven geotextile fabric roll.
- Steel Studded T-Posts 5.5 ft (1.68 m) in length and weight of 1.25 lb/ft (37 kg/m) with maximum spacing every 4 ft (1.22 m) on center around areas of increased impoundment.
- Three UV stabilized, black, 50 lb (22 kg) minimum tensile strength zip ties attach fabric to posts at the top 6 in. (15.2 cm) of fabric and attach dewatering board to t-posts on either side of the board.
- Post-fabric attachment is shown in Figure 3.2c.



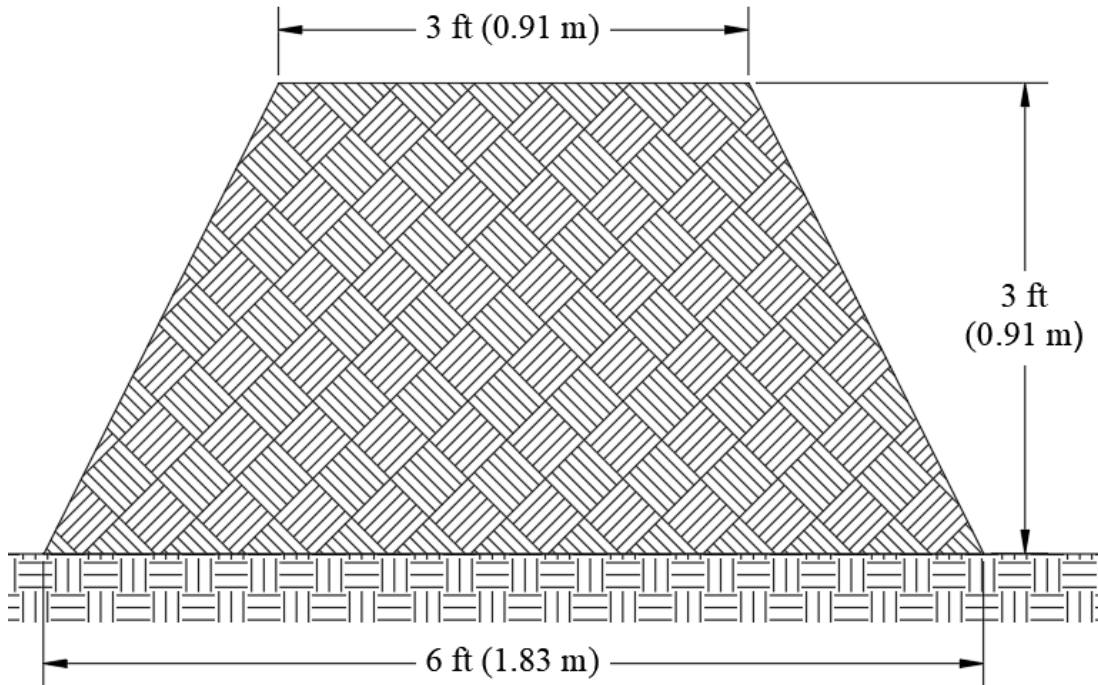
**Offset Trench Detail**



**Dewatering Board w/ Overflow Weir Detail**

### Slash Mulch Berm Specifications

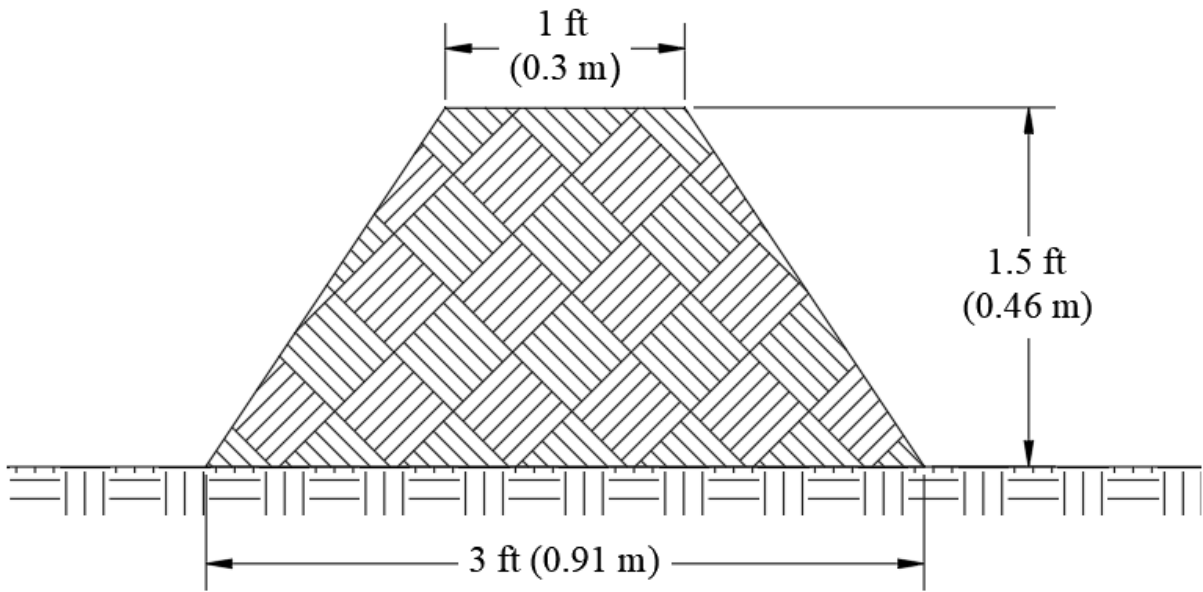
- Width and length of individual pieces material are not to exceed 2 in. and 20 in. (5.1 cm and 50.8 cm), respectively, for all installations.



**Slash Mulch Berm Standard Cross-Section**

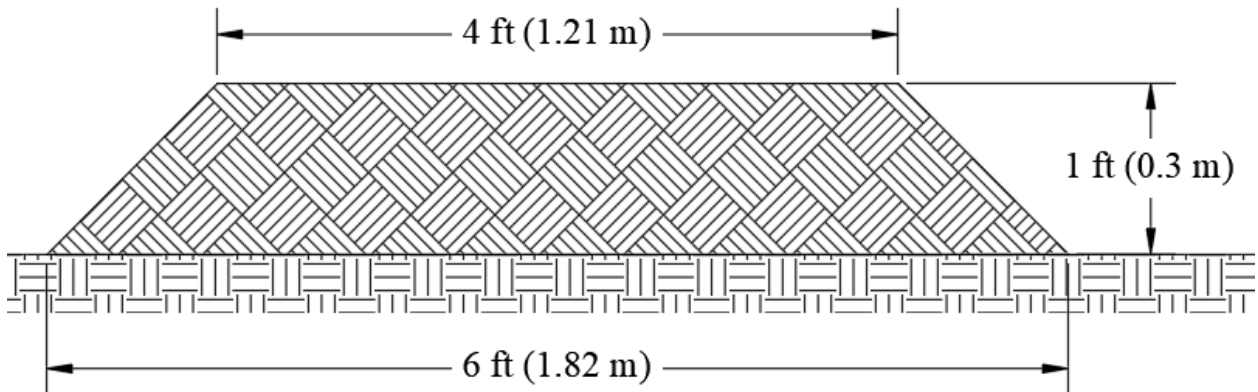
- Standard Slash Mulch berm installation was not compacted.





**Slash Mulch Berm Modification 1 (MFE-I) Cross-Section**

- Modification 1 was compacted in three 6 in. (15.2 cm) lifts.

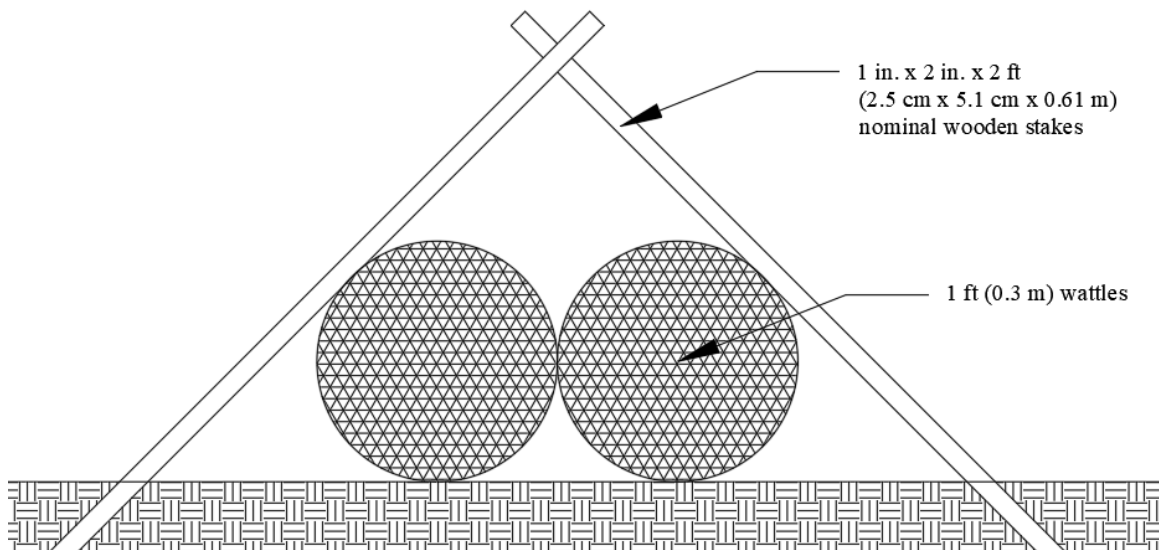


**Slash Mulch Berm Modification 2 Cross-Section**

- Modification 2 was compacted in two 6 in. (15.2 cm) lifts.

## Wattle MFE-I Specifications

- 1 ft (0.3 m) diameter wattles
- 6 in. (15.2 cm) sod staples every 1 ft (0.3 m) on both sides of wattles
- 45-degree non-destructive teepee staking at joints
- Installed 10 ft (3 m) from the toe of the slope
- 2 ft (0.61 m) overlap at joints



**Wattle Joint Staking Detail**